

DISTRIBUTED BY:

**AZTECH GENERAL TRADING LLC**

P.O. BOX: 239101, AL QUSAIS INDUSTRIAL AREA 2

DUBAI, UNITED ARAB EMIRATES

# CATALOG

## FLEXI LED STRIP LIGHTS SERIES

LED STRIP LIGHTS 2018 VERSION



# LED TAPE LIGHT



## Applications

1. Cove lighting
2. Architectural lights for canopy, corridor, window, archway
3. Backlight or edge lighting for signage
4. DIY lights for home use
5. Decorative lights for holiday, event, show, exhibition
6. Decorative lights for automobile
7. Ideal replacement of incandescent and fluorescent light

## Features

1. Line voltage 120VAC and 230VAC.
2. Low-voltage 5VDC, 12VDC and 24VDC.
3. Several LED for option SMD2835, SMD3528, SMD5050, SMD5630, SMD2216, SMD3535, SMD3014.
4. RA 94+ and RA 90+ for option, RA 97+ is available.
5. Low heat radiation and power consumption.
6. Use controller and dimmer to change color and brightness.
7. 3M double side adhesive tape at the back of the strip for easy fixing.
8. Each type of LED strip can match the suitable aluminum profile.



# Full Spectrum

## Product Features

1. Simulates natural outdoor light.
2. Portrays true colors.
3. Reduces glare, fatigue, and eye strain.
4. Illuminates details and color.
5. Makes work environments more productive.
6. Brings the benefits and beauty of the outdoors to a building's interior space.

# ES-FS2835C-112-24-Y

①

②

③

④

⑤

1

**LED Type**  
SMD2835

1800 K	2100 K	2300 K	2700 K	3000 K
3500 K	4000 K	5000 K	6500 K	

2

**Color**

3

**LED Qty.per meter**  
112 | 60

4

**Input DC Voltage**  
24VDC | 12VDC

5

**IP Index**  
IP 20 | IP54 | IP65  
IP67 | IP68

Model	Color temp.	Chip Size (mil)	Luminous Flux@60mA		I <sub>F</sub>		CRl(Ra)
			Min.	Max.	Current	Max.	
SMD2835 	1800K	10x30	20LM	22LM	60mA	150mA	94+
	2100K	10x30	20LM	22LM	60mA	150mA	94+
	2300K	10x30	20LM	22LM	60mA	150mA	94+
	2700K	10x30	20LM	22LM	60mA	150mA	94+
	3000K	10x30	20LM	22LM	60mA	150mA	94+
	3500K	10x30	20LM	22LM	60mA	150mA	94+
	4000K	10x30	20LM	22LM	60mA	150mA	94+
	5000K	10x30	20LM	22LM	60mA	150mA	94+
	6500K	10x30	20LM	22LM	60mA	150mA	94+

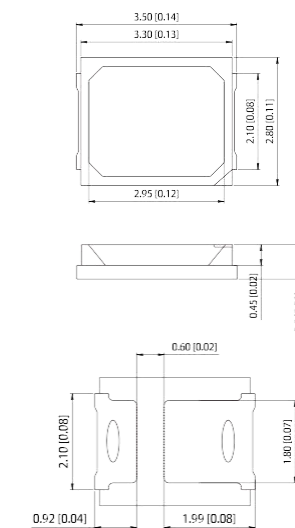

# Full Spectrum

Part Number:ES-FS2835C-112-24-Y

Model	Color temp.	LM/M	Power/M	Light efficiency	CRI (Ra)	FPC copper
ES-FS2835WW-112-24-Y	1800K	1512LM	<16.8W	90LM/W	94+	3OZ
ES-FS2835WW-112-24-Y	2100K	1512LM	<16.8W	90LM/W	94+	3OZ
ES-FS2835WW-112-24-Y	2300K	1596LM	<16.8W	95LM/W	94+	3OZ
ES-FS2835WW-112-24-Y	2700K	1596LM	<16.8W	95LM/W	94+	3OZ
ES-FS2835WW-112-24-Y	3000K	1596LM	<16.8W	95LM/W	94+	3OZ
ES-FS2835WW-112-24-Y	3500K	1630LM	<16.8W	97LM/W	94+	3OZ
ES-FS2835NW-112-24-Y	4000K	1680LM	<16.8W	100LM/W	94+	3OZ
ES-FS2835NW-112-24-Y	5000K	1680LM	<16.8W	100LM/W	94+	3OZ
ES-FS2835PW-112-24-Y	6500K	1646LM	<16.8W	98LM/W	94+	3OZ

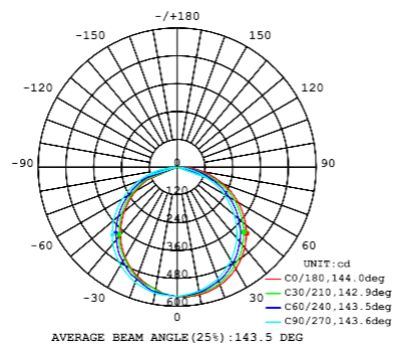

Strip length: CE:500CM UL:16.4FT

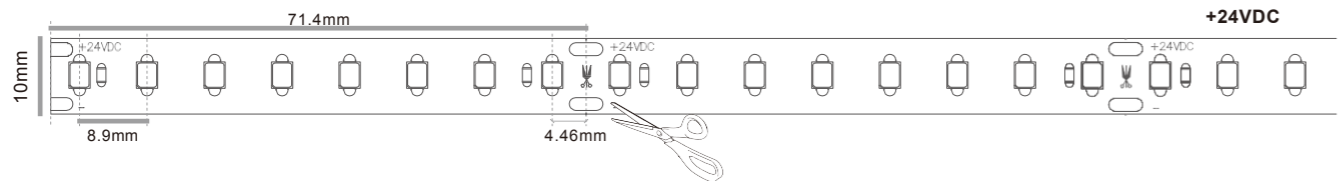

### IP Rating:

- IP20---Non waterproof
- IP54---Nano coated
- IP65---Silicon coated
- IP67---Silicon coated & Wrapped heat shrink tube
- IP67---PVC extrusion
- IP67---Silicon extrusion
- IP67---Silicon tube(transparent)
- IP68---Silicon tube(transparent) & Inject silicon glue

### AL. profiles (mm)

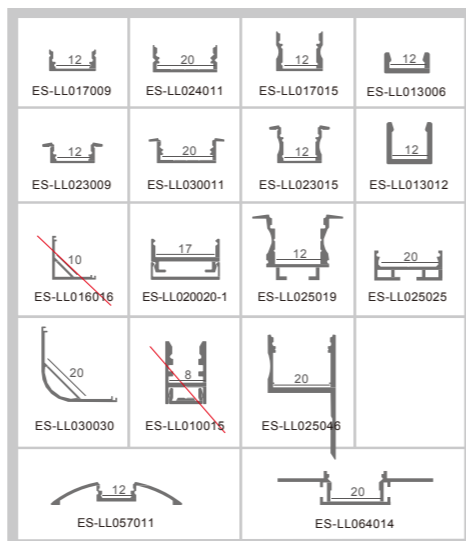

# Full Spectrum

Part Number:ES-FS2835C-60-24-Y  
 Part Number:ES-FS2835C-60-12-Y

Model	Color temp.	LM/M	Power/M	CRI (Ra)	FPC copper
ES-FS2835WW-60-24-Y	1800K	770LM	<14.4W	94+	3OZ
ES-FS2835WW-60-24-Y	2100K	770LM	<14.4W	94+	3OZ
ES-FS2835WW-60-24-Y	2300K	790LM	<14.4W	94+	3OZ
ES-FS2835WW-60-24-Y	2700K	800LM	<14.4W	94+	3OZ
ES-FS2835WW-60-24-Y	3000K	800LM	<14.4W	94+	3OZ
ES-FS2835WW-60-24-Y	3500K	820LM	<14.4W	94+	3OZ
ES-FS2835NW-60-24-Y	4000K	844LM	<14.4W	94+	3OZ
ES-FS2835NW-60-24-Y	5000K	844LM	<14.4W	94+	3OZ
ES-FS2835PW-60-24-Y	6500K	830LM	<14.4W	94+	3OZ

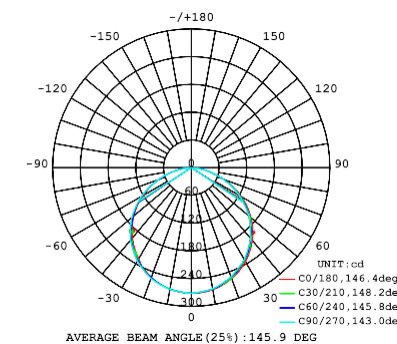

Strip length: CE:500CM UL:21.33FT(24V) | 13.12FT(12V)

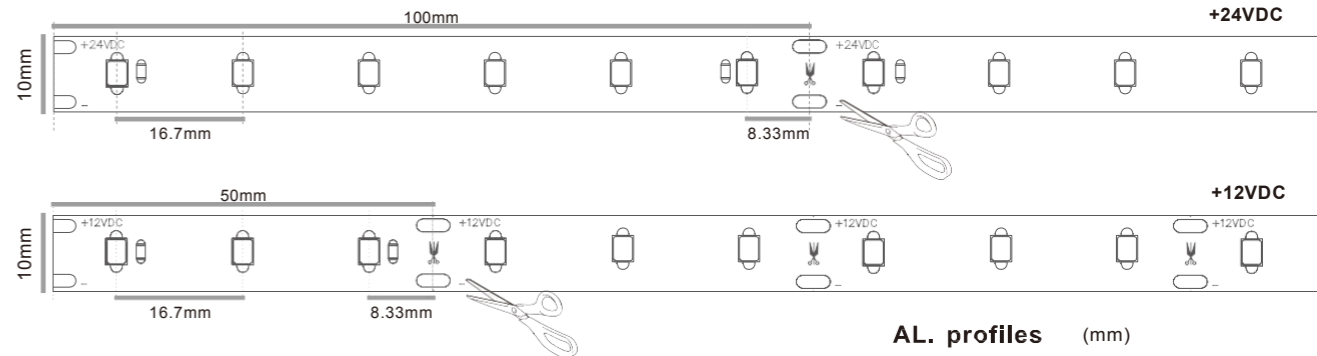

### IP Rating:

- IP20---Non waterproof
- IP54---Nano coated
- IP65---Silicon coated
- IP67---Silicon coated & Wrapped heat shrink tube
- IP67---PVC extrusion
- IP67---Silicon extrusion
- IP67---Silicon tube(transparent)
- IP68---Silicon tube(transparent) & Inject silicon glue

### AL. profiles (mm)

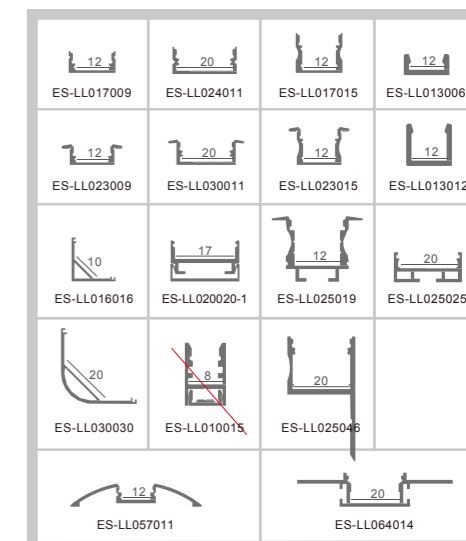

# Wall Washer

## Optical Lens LED Tape Light

### Product Features

1. Multiple angles are available, different beam angles, for different environments · Optional angle: Single angle 10°/30°/45°/60°/90°/110°  
Dual-angle 10°x30°/10°x45°/10°x60°/30°x70°.
2. Can replace the traditional LED Tape Light to achieve the effect of wall-washing, can also be used as a cabinet lamp or household lighting.
3. PMMA lens with Silicone encapsulation for durability, reliability, and ease of installation Run Length:20m/Roll.
4. Mounting method:3M glue tape or mounting clips or match with the aluminum profile.

# ES-FS2835C-42-24-10°

①

②

③

④

⑤

1

**LED Type**  
SMD2835

2

**LED Qty.per meter**  
42

3

**Input DC Voltage**  
24VDC

4

5

**Beaming Angle**  
Single Angle 10°  
Dual Angle 10°x 45°

**Color**  
1800-6500  
K K

# Wall Washer

Part Number: ES-FS2835C-42-24-10°

Model	Color temp.	LM/M	Power/M	CRI (Ra)	Beaming Angle
ES-FS2835WW-42-24-10°	1800-6500 1800K	1265LM	<21W	94+	10°



Strip length: CE:2000CM UL:32.8FT

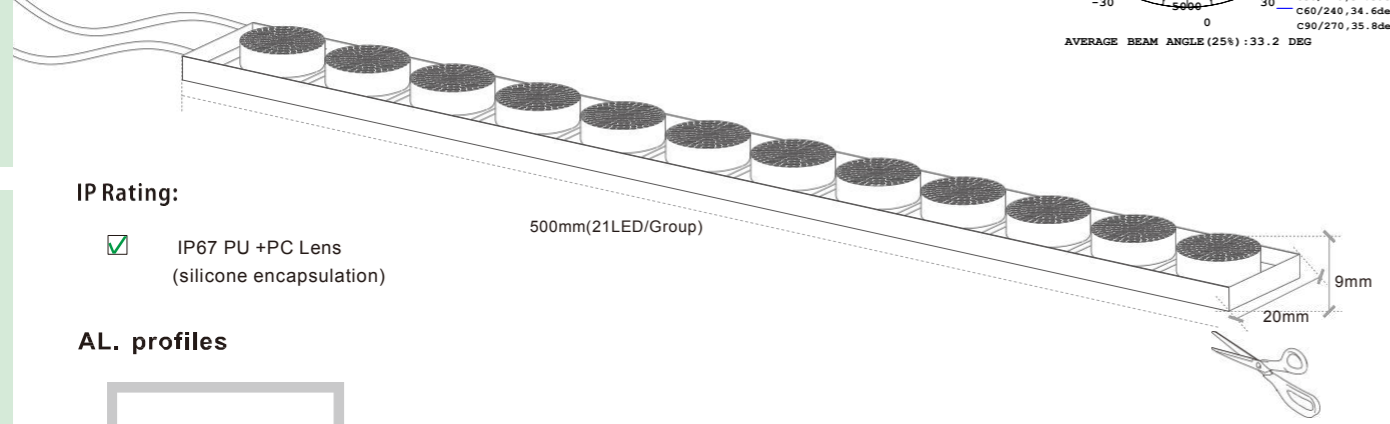
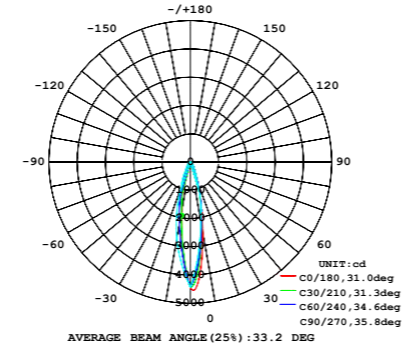

**IP Rating:**  
 IP67 PU +PC Lens (silicone encapsulation)

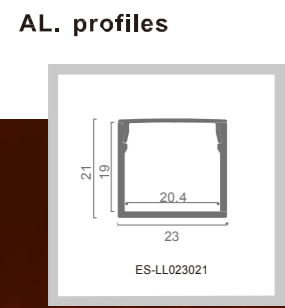

# Wall Washer

Part Number: ES-FS2835C-42-24-(10°x45°)

Model	Color temp.	LM/M	Power/M	CRI (Ra)	Beaming Angle
ES-FS2835WW-42-24-10x45°	1800-6500 1800K	1129LM	<21W	94+	10°x45°



Strip length: CE:2000CM UL:32.8FT

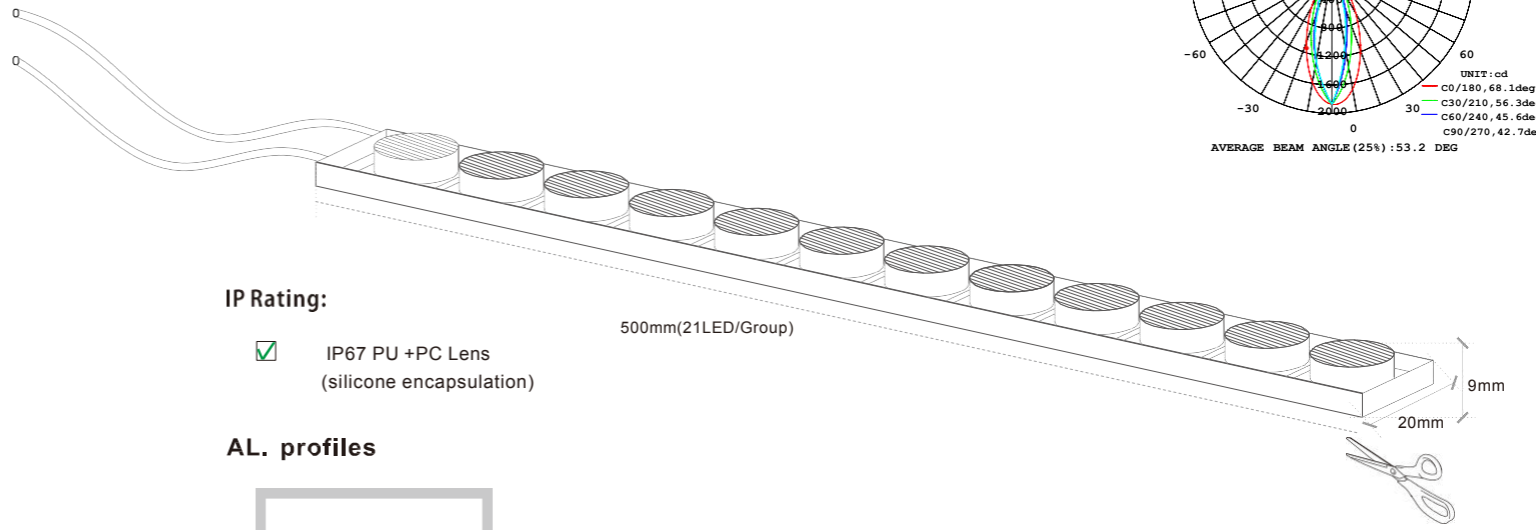
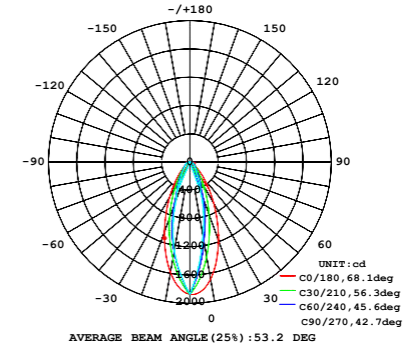

**IP Rating:**  
 IP67 PU +PC Lens (silicone encapsulation)

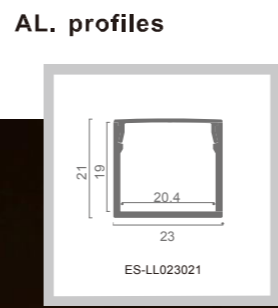

# Ultralong

## 48VDC LED Tape Light

### Product Features

1. Ultralong for one piece, Max. run 50m.
2. High light efficiency design, 115LM/W.
3. With low heat and low current, energy saving and environmental friendly.

# ES-FS3528CC-120-48-Y

① ②③ ④ ⑤ ⑥

**Color**

**LED Qty. per meter**  
120 | 60

**IP Index**  
IP 20 | IP54 | IP65  
IP67 | IP68

**LED Type**  
SMD3528 | SMD2835

**Constant Current**  
WWC | NWC | PWC

**Input DC Voltage**  
48VDC

2700 K	3000 K	3500 K
4000 K	5000 K	6500 K

Model	CCT Wave lengths	Chip Size (mil)	Luminous Flux@20mA		I <sub>F</sub>		CRI(Ra)
			Min.	Max.	Current	Max.	
SMD3528	2700K	8x15	7LM	9LM	20mA	30mA	90+
	3000K	8x15	7LM	9LM	20mA	30mA	90+
	3500K	8x15	7LM	9LM	20mA	30mA	90+
	4000K	8x15	7LM	9LM	20mA	30mA	90+
	5000K	8x15	7LM	9LM	20mA	30mA	90+
	6500K	8x15	7LM	9LM	20mA	30mA	90+
	620-625 NM NM	8x15	---	---	20mA	30mA	---
	585-590 NM NM	8x15	---	---	20mA	30mA	---
	517-522 NM NM	8x15	---	---	20mA	30mA	---
	465-470 NM NM	8x15	---	---	20mA	30mA	---

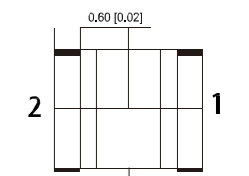
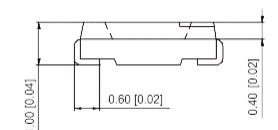
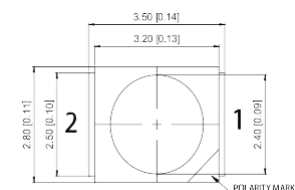

LED Strip Light

LED Strip Light Accessory

Aluminum Profile

LED Linear Luminaire

LED Panel Light

LED Panel Light Accessory

LED Strip Light

LED Strip Light Accessory

Aluminum Profile

LED Linear Luminaire

LED Panel Light

LED Panel Light Accessory

# 48VDC LED TAPE LIGHT

Part Number:ES-FS3528CC-120-48-Y

Model	Color temp. Wave lengths	LM/M	Power/M	CRI (Ra)	FPC copper
ES-FS3528WWC-120-48-Y	2700K	390LM	<6.6W	90+	4OZ
ES-FS3528WWC-120-48-Y	3000K	410LM	<6.6W	90+	4OZ
ES-FS3528WWC-120-48-Y	3500K	410LM	<6.6W	90+	4OZ
ES-FS3528NWC-120-48-Y	4000K	430LM	<6.6W	90+	4OZ
ES-FS3528NWC-120-48-Y	5000K	430LM	<6.6W	90+	4OZ
ES-FS3528PWC-120-48-Y	6500K	430LM	<6.6W	90+	4OZ
ES-FS3528RC-120-48-Y	620-625 NM NM	---	<6.6W	90+	4OZ
ES-FS3528YC-120-48-Y	585-590 NM NM	---	<6.6W	90+	4OZ
ES-FS3528GC-120-48-Y	517-522 NM NM	---	<6.6W	90+	4OZ
ES-FS3528BC-120-48-Y	465-470 NM NM	---	<6.6W	90+	4OZ

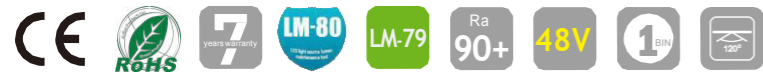
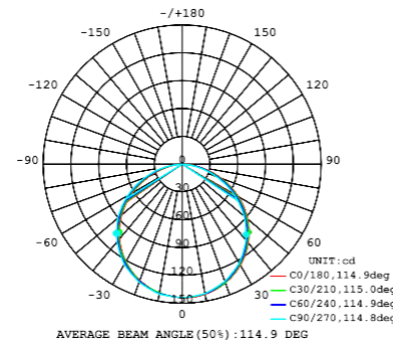

Strip length: CE:5000CM UL:49.54FT



AL. profiles (mm)

ES-LL017009	ES-LL024011	ES-LL017015	ES-LL013006
ES-LL023009	ES-LL030011	ES-LL023015	ES-LL013012
ES-LL016016	ES-LL020020-1	ES-LL025019	ES-LL025025
ES-LL030030	ES-LL010015	ES-LL025046	
ES-LL057011	ES-LL064014		

IP Rating:

- IP20---Non waterproof
- IP54---Nano coated
- IP65---Silicon coated
- IP67---Silicon coated & Wrapped heat shrink tube
- IP67---PVC extrusion
- IP67---Silicon extrusion
- IP67---Silicon tube(transparent)
- IP68---Silicon tube(transparent) & Inject silicon glue

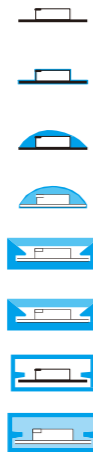

# 48VDC LED TAPE LIGHT

Part Number:ES-FS2835C-120-48-Y

Model	Color temp.	LM/M	Power/M	Light efficiency	CRI (Ra)	FPC copper
ES-FS2835WW-120-48-Y	1800K	1400LM	<16.8W	83LM/W	94+	3OZ
ES-FS2835WW-120-48-Y	2100K	1500LM	<16.8W	89LM/W	94+	3OZ
ES-FS2835WW-120-48-Y	2300K	1600LM	<16.8W	95LM/W	94+	3OZ
ES-FS2835WW-120-48-Y	2700K	1850LM	<16.8W	110LM/W	94+	3OZ
ES-FS2835WW-120-48-Y	3000K	1850LM	<16.8W	110LM/W	94+	3OZ
ES-FS2835WW-120-48-Y	3500K	1850LM	<16.8W	110LM/W	94+	3OZ
ES-FS2835NW-120-48-Y	4000K	1930LM	<16.8W	115LM/W	94+	3OZ
ES-FS2835NW-120-48-Y	5000K	1930LM	<16.8W	115LM/W	94+	3OZ
ES-FS2835PW-120-48-Y	6500K	1930LM	<16.8W	115LM/W	94+	3OZ

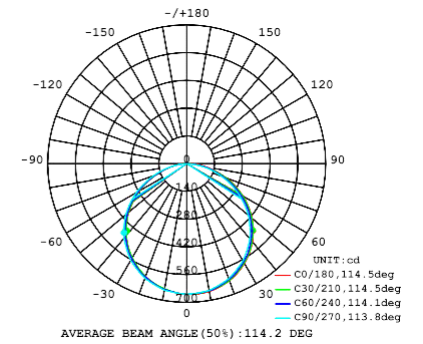

Strip length: CE:1200CM UL:19.28FT

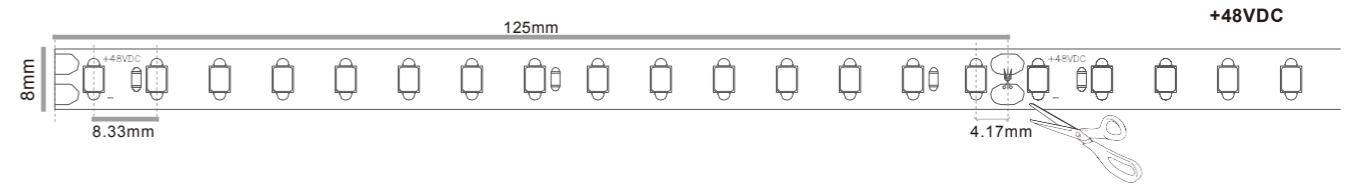

AL. profiles (mm)

ES-LL017009	ES-LL024011	ES-LL017015	ES-LL013006
ES-LL023009	ES-LL030011	ES-LL023015	ES-LL013012
ES-LL016016	ES-LL020020-1	ES-LL025019	ES-LL025025
ES-LL030030	ES-LL010015	ES-LL025046	
ES-LL057011	ES-LL064014		

IP Rating:

- IP20---Non waterproof
- IP54---Nano coated
- IP65---Silicon coated
- IP67---Silicon coated & Wrapped heat shrink tube
- IP67---PVC extrusion
- IP67---Silicon extrusion
- IP67---Silicon tube(transparent)
- IP68---Silicon tube(transparent) & Inject silicon glue

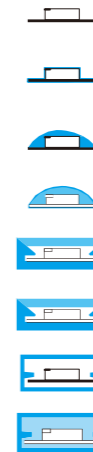



# 48VDC LED TAPE LIGHT

Part Number:ES-FS2835C-60-48-Y

Model	Color temp.	LM/M	Power/M	Light efficiency	CRI (Ra)	FPC copper
ES-FS2835WW-60-48-Y	1800K	920LM	<11.4W	81LM/W	94+	3OZ
ES-FS2835WW-60-48-Y	2100K	920LM	<11.4W	81LM/W	94+	3OZ
ES-FS2835WW-60-48-Y	2300K	1050LM	<11.4W	92LM/W	94+	3OZ
ES-FS2835WW-60-48-Y	2700K	1200LM	<11.4W	105LM/W	94+	3OZ
ES-FS2835WW-60-48-Y	3000K	1200LM	<11.4W	105LM/W	94+	3OZ
ES-FS2835WW-60-48-Y	3500K	1200LM	<11.4W	105LM/W	94+	3OZ
ES-FS2835NW-60-48-Y	4000K	1250LM	<11.4W	109LM/W	94+	3OZ
ES-FS2835NW-60-48-Y	5000K	1250LM	<11.4W	109LM/W	94+	3OZ
ES-FS2835PW-60-48-Y	6500K	1250LM	<11.4W	109LM/W	94+	3OZ

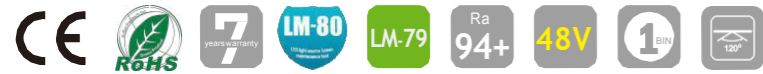
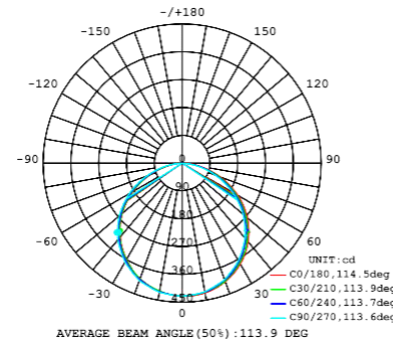

Strip length: CE:1500CM UL:28.63FT

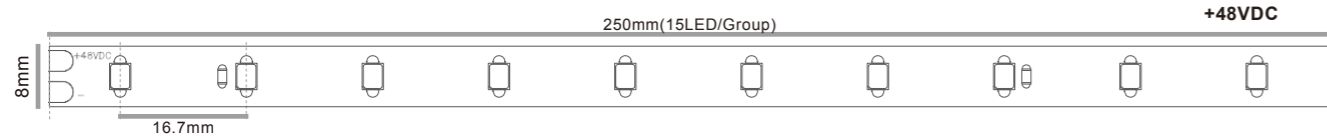

## AL. profiles (mm)

ES-LL017009	ES-LL024011	ES-LL017015	ES-LL013006
ES-LL023009	ES-LL030011	ES-LL023015	ES-LL013012
ES-LL016016	ES-LL020020-1	ES-LL025019	ES-LL025025
ES-LL030030	ES-LL010015	ES-LL025046	
ES-LL057011	ES-LL064014		

## IP Rating:

- IP20---Non waterproof
- IP54---Nano coated
- IP65---Silicon coated
- IP67---Silicon coated & Wrapped heat shrink tube
- IP67---PVC extrusion
- IP67---Silicon extrusion
- IP67---Silicon tube(transparent)
- IP68---Silicon tube(transparent) & Inject silicon glue

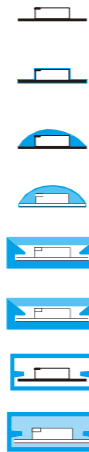

# 48VDC LED TAPE LIGHT

Part Number:ES-FS3528C-120-48-Y

Model	Color temp. Wave lengths	LM/M	Power/M	Light efficiency	CRI (Ra)	FPC copper
ES-FS3528WW-120-48-Y	2700K	860LM	<7.6W	113LM/W	90+	3OZ
ES-FS3528WW-120-48-Y	3000K	860LM	<7.6W	113LM/W	90+	3OZ
ES-FS3528WW-120-48-Y	3500K	860LM	<7.6W	113LM/W	90+	3OZ
ES-FS3528NW-120-48-Y	4000K	900LM	<7.6W	118LM/W	90+	3OZ
ES-FS3528NW-120-48-Y	5000K	900LM	<7.6W	118LM/W	90+	3OZ
ES-FS3528PW-120-48-Y	6500K	900LM	<7.6W	118LM/W	90+	3OZ
ES-FS3528R-120-48-Y	620-625 NM NM	---	<7.6W	---	90+	3OZ
ES-FS3528Y-120-48-Y	585-590 NM NM	---	<7.6W	---	90+	3OZ
ES-FS3528G-120-48-Y	517-522 NM NM	---	<7.6W	---	90+	3OZ
ES-FS3528B-120-48-Y	465-470 NM NM	---	<7.6W	---	90+	3OZ

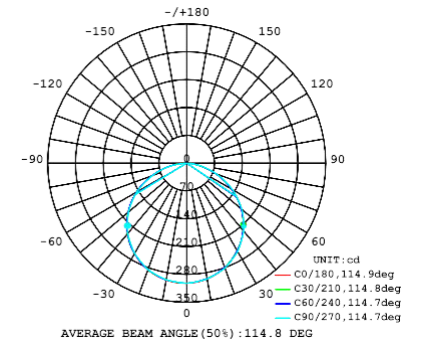

Strip length: CE:1700CM UL:43.07FT

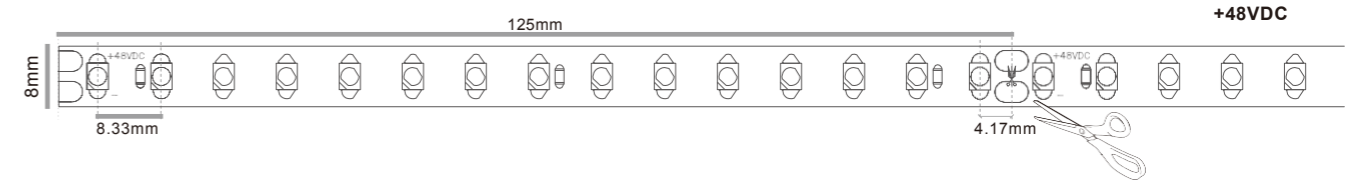

## AL. profiles (mm)

ES-LL017009	ES-LL024011	ES-LL017015	ES-LL013006
ES-LL023009	ES-LL030011	ES-LL023015	ES-LL013012
ES-LL016016	ES-LL020020-1	ES-LL025019	ES-LL025025
ES-LL030030	ES-LL010015	ES-LL025046	
ES-LL057011	ES-LL064014		

## IP Rating:

- IP20---Non waterproof
- IP54---Nano coated
- IP65---Silicon coated
- IP67---Silicon coated & Wrapped heat shrink tube
- IP67---PVC extrusion
- IP67---Silicon extrusion
- IP67---Silicon tube(transparent)
- IP68---Silicon tube(transparent) & Inject silicon glue

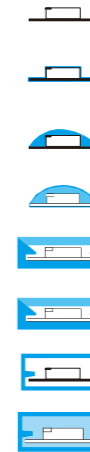

# 48VDC LED TAPE LIGHT

Part Number: ES-FS3528C-60-48-Y

Model	Color temp. Wave lengths	LM/M	Power/M	Light efficiency	CRI (Ra)	FPC copper
ES-FS3528WW-60-48-Y	2700K	420LM	<3.8W	110LM/W	90+	3OZ
ES-FS3528WW-60-48-Y	3000K	420LM	<3.8W	110LM/W	90+	3OZ
ES-FS3528WW-60-48-Y	3500K	420LM	<3.8W	110LM/W	90+	3OZ
ES-FS3528NW-60-48-Y	4000K	440LM	<3.8W	115LM/W	90+	3OZ
ES-FS3528NW-60-48-Y	5000K	440LM	<3.8W	115LM/W	90+	3OZ
ES-FS3528PW-60-48-Y	6500K	440LM	<3.8W	115LM/W	90+	3OZ
ES-FS3528R-60-48-Y	620-625 NM NM	---	<3.8W	---	90+	3OZ
ES-FS3528Y-60-48-Y	585-590 NM NM	---	<3.8W	---	90+	3OZ
ES-FS3528G-60-48-Y	517-522 NM NM	---	<3.8W	---	90+	3OZ
ES-FS3528B-60-48-Y	465-470 NM NM	---	<3.8W	---	90+	3OZ

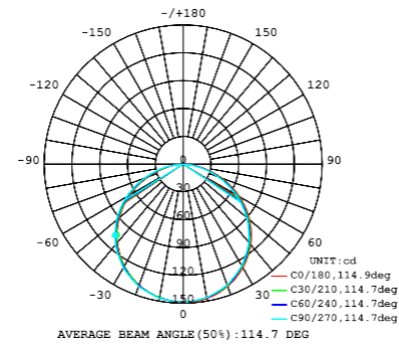

Strip length: **CE:2500CM** **UL:86.13FT**

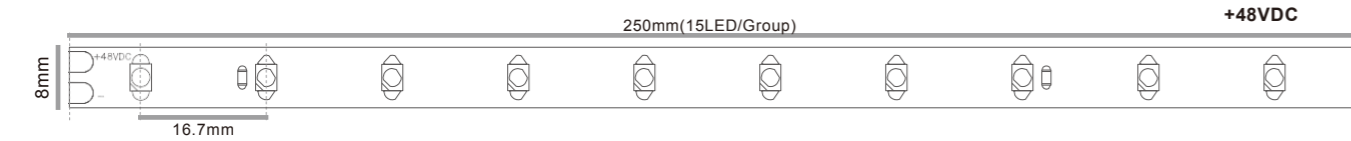

### IP Rating:

- IP20---Non waterproof
- IP54---Nano coated
- IP65---Silicon coated
- IP67---Silicon coated & Wrapped heat shrink tube
- IP67---PVC extrusion
- IP67---Silicon extrusion
- IP67---Silicon tube(transparent)
- IP68---Silicon tube(transparent) & Inject silicon glue

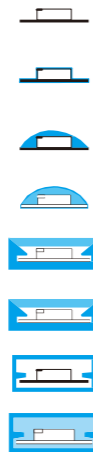

### AL. profiles (mm)

ES-LL017009	ES-LL024011	ES-LL017015	ES-LL013006
ES-LL023009	ES-LL030011	ES-LL023015	ES-LL013012
ES-LL016016	ES-LL020020-1	ES-LL025019	ES-LL025025
ES-LL030030	ES-LL010015	ES-LL025046	
ES-LL057011	ES-LL064014		

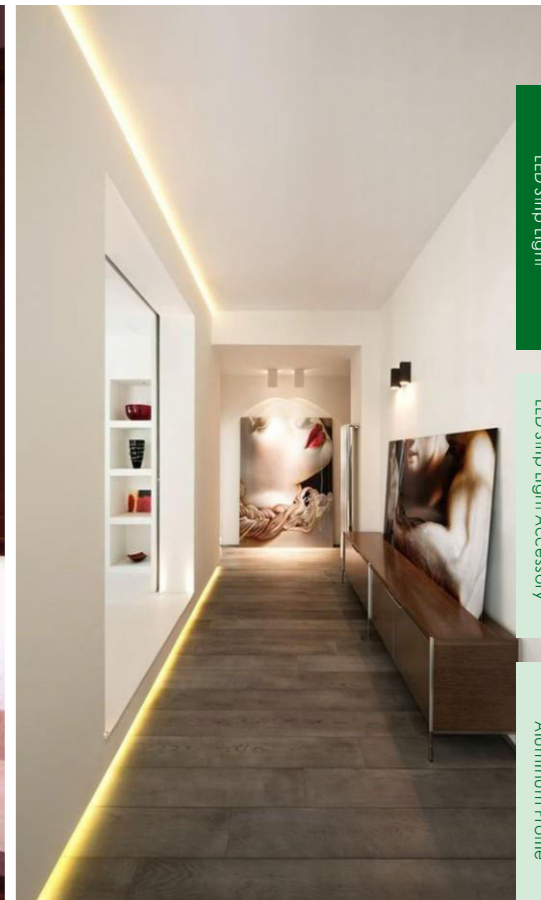
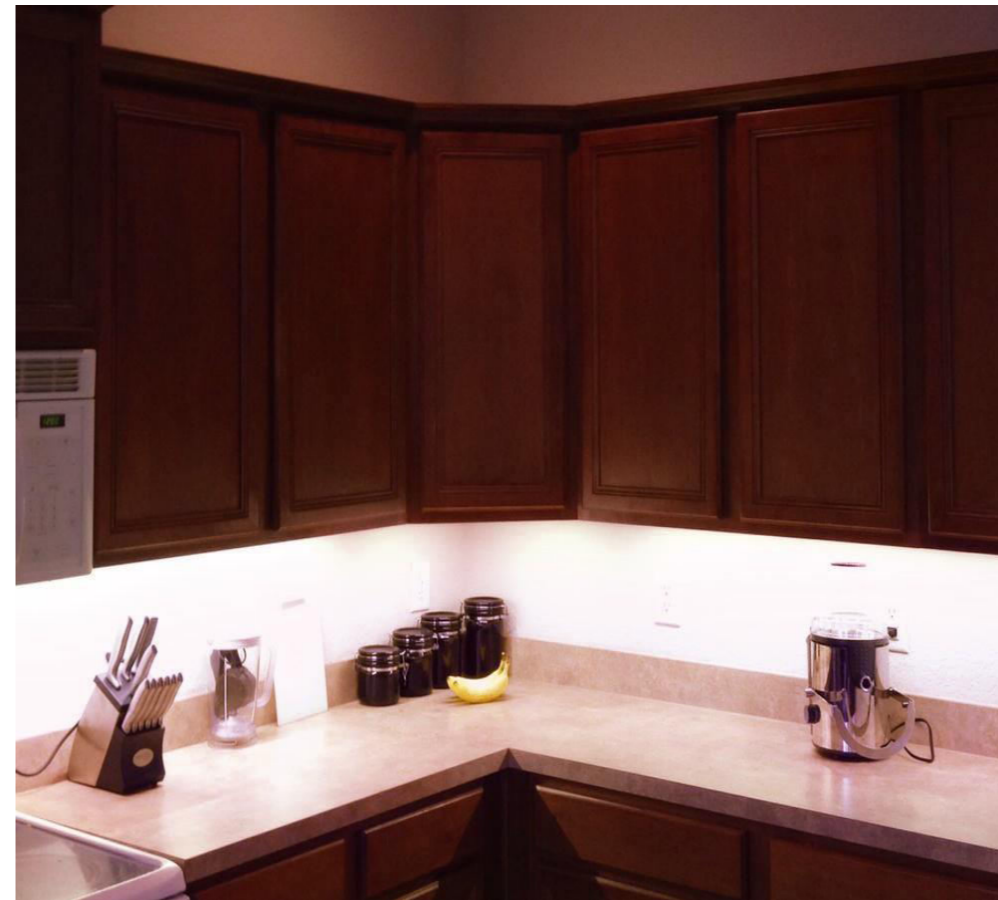

LED Strip Light

LED Strip Light Accessory

Aluminum Profile

LED Linear Luminaire

LED Panel Light

LED Panel Light Accessory

LED Strip Light

LED Strip Light Accessory

Aluminum Profile

LED Linear Luminaire

LED Panel Light

LED Panel Light Accessory

# ES-FS3528CC-120-24-Y

① ② ③ ④ ⑤ ⑥

## Ultralong

### Constant Current LED Tape Light

#### Product Features

1. The biggest advantage of constant current strip is its constant current circuit design, which makes every LED in constant current state, and then greatly improved the life time of the LEDs.
2. For single color, 20M/40M are available. Electrified at one end, could achieve low voltage drop, no obvious brightness difference.
3. For RGB color, 10M/reel is available with electrifying at one end.

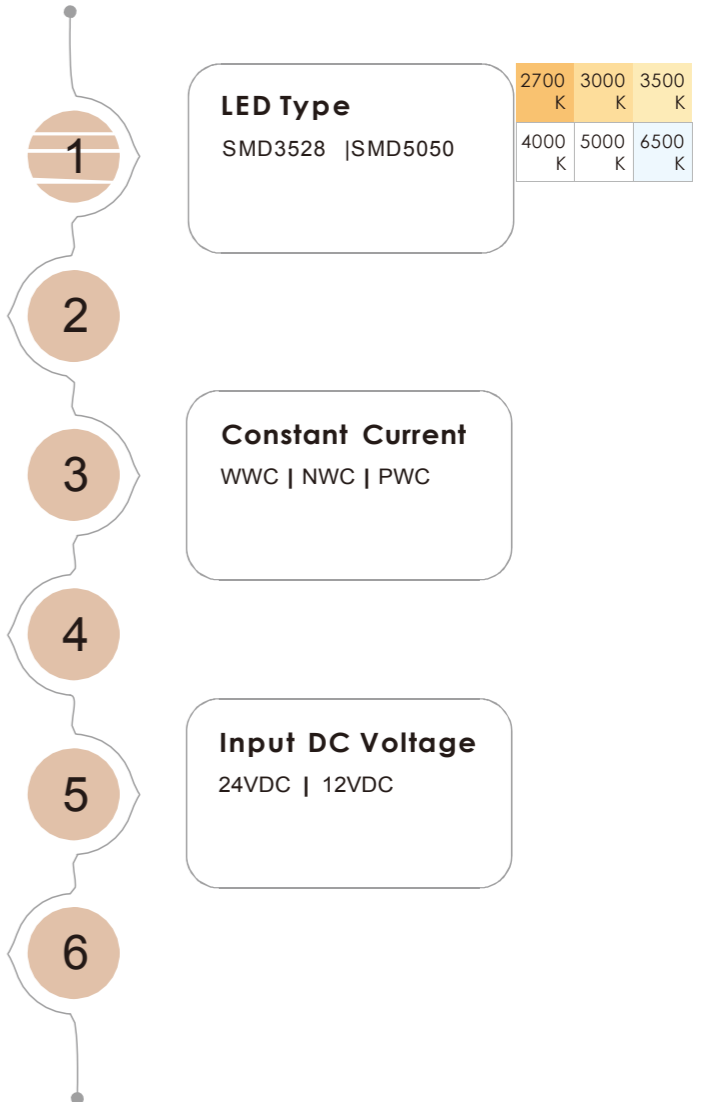

**LED Type**  
SMD3528 | SMD5050

2700 K	3000 K	3500 K
4000 K	5000 K	6500 K

**Color**

**LED Qty. per meter**  
120 | 60

**IP Index**  
IP 20 | IP54 | IP65  
IP67 | IP68

**Constant Current**  
WWC | NWC | PWC

**Input DC Voltage**  
24VDC | 12VDC

## Constant Current

### Part Number: ES-FS3528CC-120-24-Y

Dimmable: **0-10V** | **PWM** | **Triac** | **DALI**

Model	Color temp. Wave lengths	LM/M	Power/M	CRI (Ra)	FPC copper
ES-FS3528WWC-120-24-Y	2700K	740LM	<9.6W	90+	4OZ
ES-FS3528WWC-120-24-Y	3000K	740LM	<9.6W	90+	4OZ
ES-FS3528WWC-120-24-Y	3500K	768LM	<9.6W	90+	4OZ
ES-FS3528NWC-120-24-Y	4000K	768LM	<9.6W	90+	4OZ
ES-FS3528NWC-120-24-Y	5000K	768LM	<9.6W	90+	4OZ
ES-FS3528PWC-120-24-Y	6500K	780LM	<9.6W	90+	4OZ
ES-FS3528RC-120-24-Y	620-625 NM NM	---	<9.6W	90+	4OZ
ES-FS3528YC-120-24-Y	585-590 NM NM	---	<9.6W	90+	4OZ
ES-FS3528GC-120-24-Y	517-522 NM NM	---	<9.6W	90+	4OZ
ES-FS3528BC-120-24-Y	465-470 NM NM	---	<9.6W	90+	4OZ

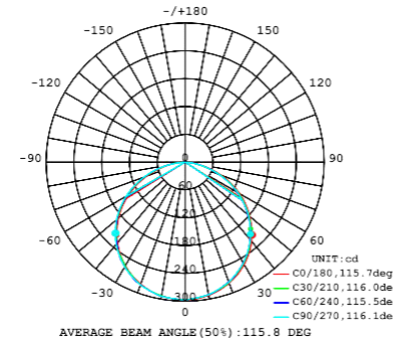

Strip length: **CE:2000CM** **UL:34FT**

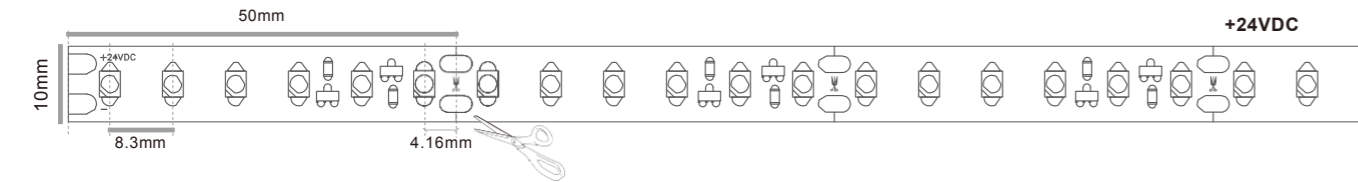

#### IP Rating:

- IP20---Non waterproof
- IP54---Nano coated
- IP65---Silicon coated
- IP67---Silicon coated & Wrapped heat shrink tube
- IP67---PVC extrusion
- IP67---Silicon extrusion
- IP67---Silicon tube(transparent)
- IP68---Silicon tube(transparent) & Inject silicon glue

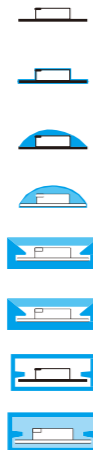

#### AL. profiles (mm)

ES-LL017009	ES-LL024011	ES-LL017015	ES-LL013006
ES-LL023009	ES-LL030011	ES-LL023015	ES-LL013012
ES-LL016016	ES-LL020020-1	ES-LL025019	ES-LL025025
ES-LL030030	ES-LL010015	ES-LL025046	
ES-LL057011	ES-LL064014		

## Constant Current

### Part Number: ES-FS3528CC-120-24-Y

Model	Color temp. Wave lengths	LM/M	Power/M	CRI (Ra)	FPC copper
ES-FS3528WWC-120-24-Y	2700K	360LM	<2.4W	90+	4OZ
ES-FS3528WWC-120-24-Y	3000K	360LM	<2.4W	90+	4OZ
ES-FS3528WWC-120-24-Y	3500K	360LM	<2.4W	90+	4OZ
ES-FS3528NWC-120-24-Y	4000K	390LM	<2.4W	90+	4OZ
ES-FS3528NWC-120-24-Y	5000K	390LM	<2.4W	90+	4OZ
ES-FS3528PWC-120-24-Y	6500K	400LM	<2.4W	90+	4OZ
ES-FS3528RC-120-24-Y	620-625 NM NM	---	<2.4W	90+	4OZ
ES-FS3528YC-120-24-Y	585-590 NM NM	---	<2.4W	90+	4OZ
ES-FS3528GC-120-24-Y	517-522 NM NM	---	<2.4W	90+	4OZ
ES-FS3528BC-120-24-Y	465-470 NM NM	---	<2.4W	90+	4OZ

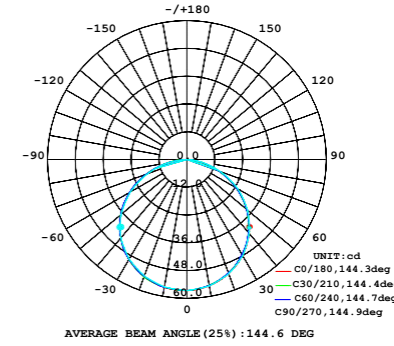

Strip length: **CE:4000CM** **UL:68FT**

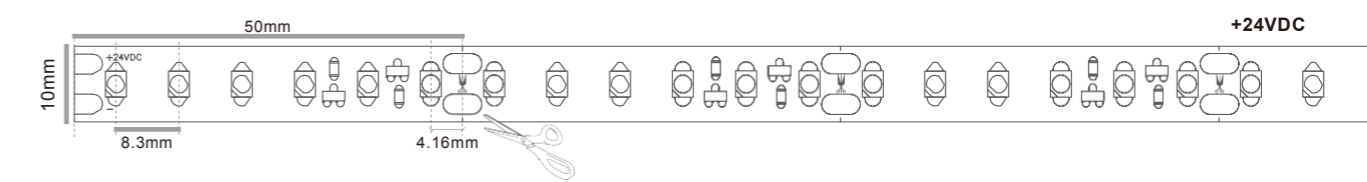

#### IP Rating:

- IP20---Non waterproof
- IP54---Nano coated
- IP65---Silicon coated
- IP67---Silicon coated & Wrapped heat shrink tube
- IP67---PVC extrusion
- IP67---Silicon extrusion
- IP67---Silicon tube(transparent)
- IP68---Silicon tube(transparent) & Inject silicon glue

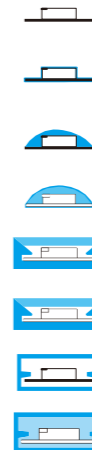

#### AL. profiles (mm)

ES-LL017009	ES-LL024011	ES-LL017015	ES-LL013006
ES-LL023009	ES-LL030011	ES-LL023015	ES-LL013012
ES-LL016016	ES-LL020020-1	ES-LL025019	ES-LL025025
ES-LL030030	ES-LL010015	ES-LL025046	
ES-LL057011	ES-LL064014		

# Constant Current

Part Number: ES-FS5050RGBC-60-24-Y

Model	Wave lengths	LM/M	Power/M	FPC copper
ES-FS5050RGBC-60-24-Y	620-625 NM NM	535LM	<14.4W	40Z
	517-522 NM NM			
	465-470 NM NM			

Model	Wave lengths	LM/FT	Power/FT	FPC copper
ES-FS5050RGBC-60-24-Y	620-625 NM NM	117LM	<2.9W	40Z
	517-522 NM NM			
	465-470 NM NM			

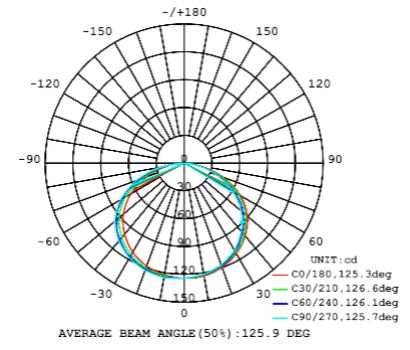

**Controller**

Product No.	Description
4.02.127	12-24VDC 3A*3CH Max.9A 108W/216W(12V/24V)



Strip length: **CE:1000CM** **UL:32.8FT**

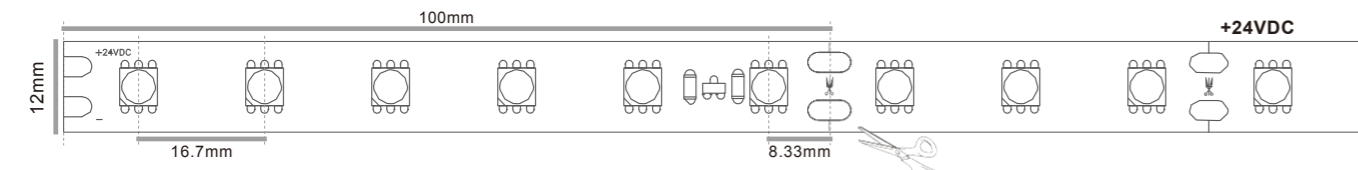

- IP Rating:**
- IP20---Non waterproof
  - IP54---Nano coated
  - IP65---Silicon coated
  - IP67---Silicon coated & Wrapped heat shrink tube
  - IP67---PVC extrusion
  - IP67---Silicon extrusion
  - IP67---Silicon tube(transparent)
  - IP68---Silicon tube(transparent) & Inject silicon glue

**AL. profiles (mm)**

ES-LL017009	ES-LL024011	ES-LL017015	ES-LL013006
ES-LL023009	ES-LL030011	ES-LL023015	ES-LL013012
ES-LL016016	ES-LL020020-1	ES-LL025019	ES-LL025025
ES-LL030030	ES-LL010015	ES-LL025046	
ES-LL057011	ES-LL064014		

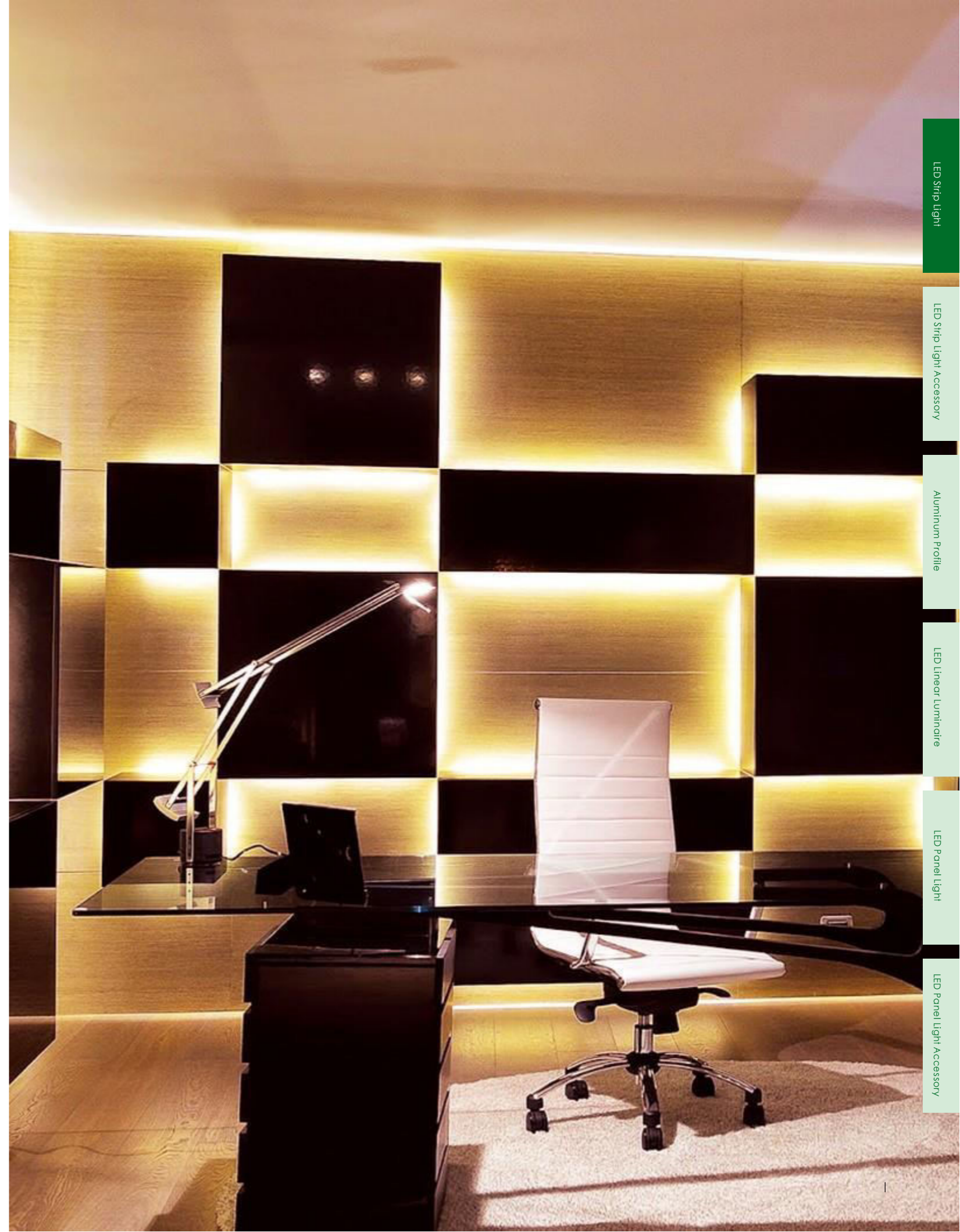

LED Strip Light

LED Strip Light Accessory

Aluminum Profile

LED Linear Luminaire

LED Panel Light

LED Panel Light Accessory

LED Strip Light

LED Strip Light Accessory

Aluminum Profile

LED Linear Luminaire

LED Panel Light

LED Panel Light Accessory

# Fresh Light

Part Number: ES-FS2835C-112-24-Y

Model	Color temp.	LM/M	Power/M	FPC copper
ES-FS2835WW-112-24-Y	fresh bread 2500K	2250LM	<16.8W	30Z
ES-FS2835WW-112-24-Y	fresh meat 2900K	2250LM	<16.8W	30Z
ES-FS2835WW-112-24-Y	fresh fruit vegetable 3000K	2300LM	<16.8W	30Z
ES-FS2835NW-112-24-Y	fresh vegetables 5000K	2350LM	<16.8W	30Z
ES-FS2835PW-112-24-Y	fresh fish 7500K	2415LM	<16.8W	30Z

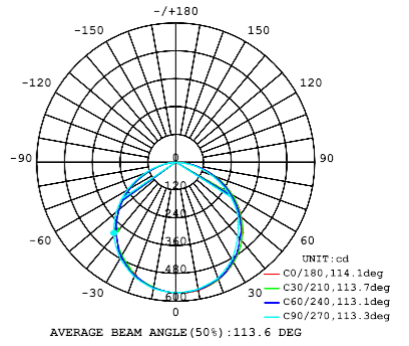

High Reliability

High light quality

Excellent color consistency

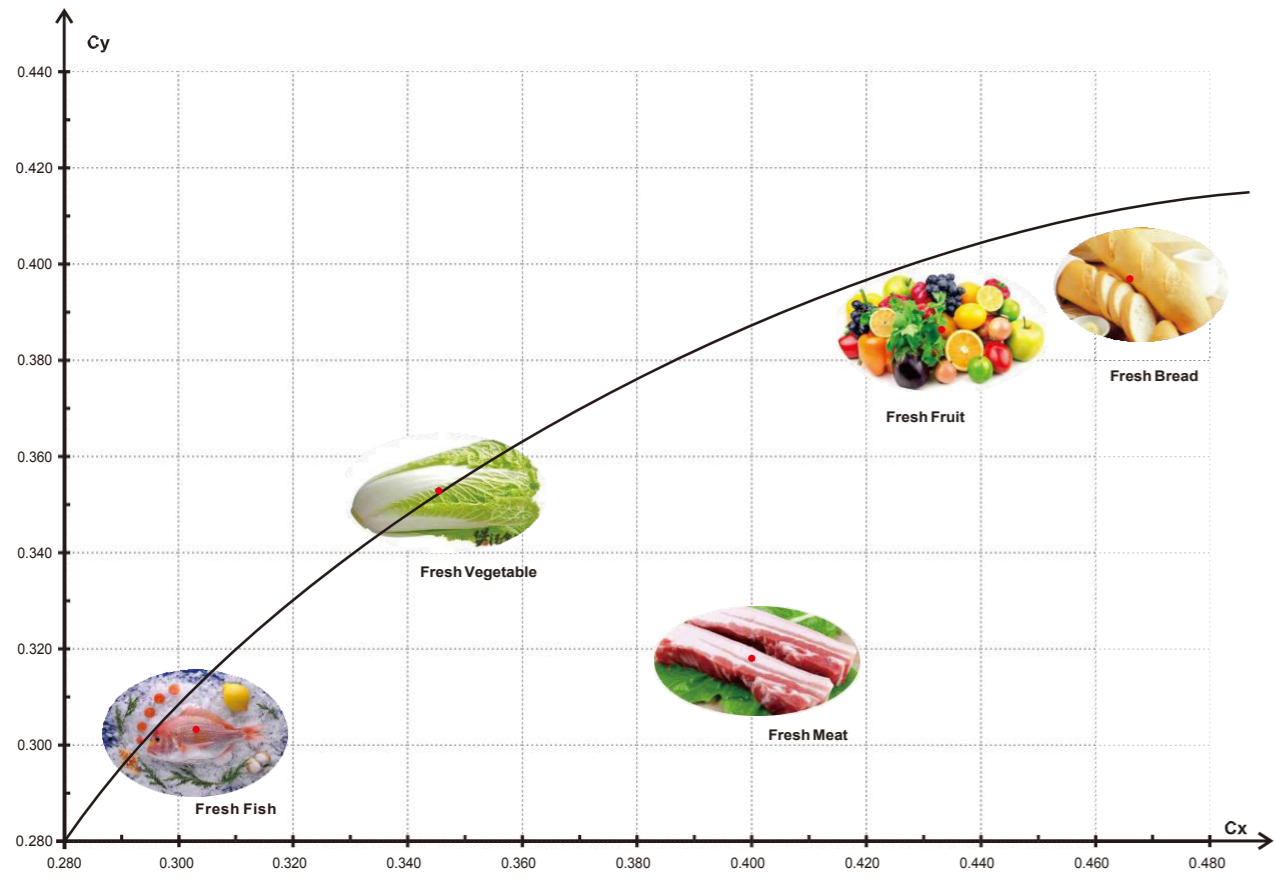

## Fresh Light

Application scenario recommendation:

1. Fresh Bread: Warm yellow, suitable for lighting in breads, cakes or retouched lighting.
2. Fresh Meat: Light pink, can make meat attractive, suitable for lighting in fresh meat and red&white sea food.
3. Fresh Fruit: Warm light yellow, suitable for lighting in Various colors of fruits and vegetables.
4. Fresh Vegetable: Bright light yellow, suitable for lighting in cabbage, greens and rice.
5. Fresh Fish: Bright blue and white, Suitable for lighting in chilled cabinets, seafood restaurants and seafood shops.

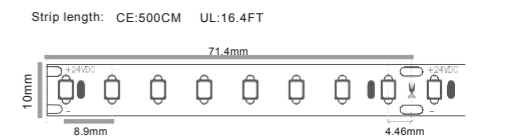

AL. profiles (mm)

ES-LL017009	ES-LL024011	ES-LL017016	ES-LL013006
ES-LL023009	ES-LL030011	ES-LL023016	ES-LL013012
ES-LL016016	ES-LL020020-1	ES-LL025019	ES-LL025025
ES-LL030030	ES-LL010016	ES-LL025048	
ES-LL057011	ES-LL064014		

LED Strip Light

LED Strip Light Accessory

Aluminum Profile

LED Linear Luminaire

LED Panel Light

LED Panel Light Accessory

LED Strip Light

LED Strip Light Accessory

Aluminum Profile

LED Linear Luminaire

LED Panel Light

LED Panel Light Accessory

# S Type(Bendable)

## LED Tape Light

### Product Features

- 1. RA 90+(SMD 3528) and RA 94+(SMD2835) for option.
- 2. 12VDC and 24VDC for option.
- 3. High flexibility – adaptable to round shapes.
- 4. Installation with 3M adhesive tape on the strip's backside (self adhesive).

# ES-FS2835C-60-24-Y(S)

① ② ③ ④ ⑤

1

### LED Type

SMD2835 | 3528

1800 K	2100 K	2300 K	2700 K	3000 K
3500 K	4000 K	5000 K	6500 K	

### Color

2

### LED Qty. per meter

60

3

### Input DC Voltage

24VDC | 12VDC

4

5

### IP Index

IP20 | IP54

## S Type(Bendable)

Part Number:ES-FS2835C-60-12-Y(S)  
Part Number:ES-FS2835C-60-24-Y(S)

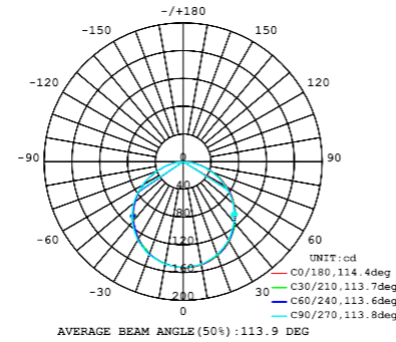
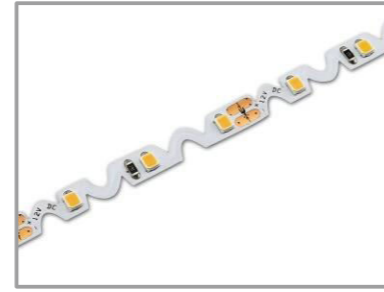

Model	Color temp.	LM/M	Power/M	CRI (Ra)	FPC copper
ES-FS2835WW-60-12-Y(S)	1800K	700LM	<12W	94+	2OZ
ES-FS2835WW-60-12-Y(S)	2100K	700LM	<12W	94+	2OZ
ES-FS2835WW-60-12-Y(S)	2300K	720LM	<12W	94+	2OZ
ES-FS2835WW-60-12-Y(S)	2700K	780LM	<12W	94+	2OZ
ES-FS2835WW-60-12-Y(S)	3000K	7800LM	<12W	94+	2OZ
ES-FS2835WW-60-12-Y(S)	3500K	800LM	<12W	94+	2OZ
ES-FS2835NW-60-12-Y(S)	4000K	840LM	<12W	94+	2OZ
ES-FS2835NW-60-12-Y(S)	5000K	840LM	<12W	94+	2OZ
ES-FS2835PW-60-12-Y(S)	6500K	890LM	<12W	94+	2OZ

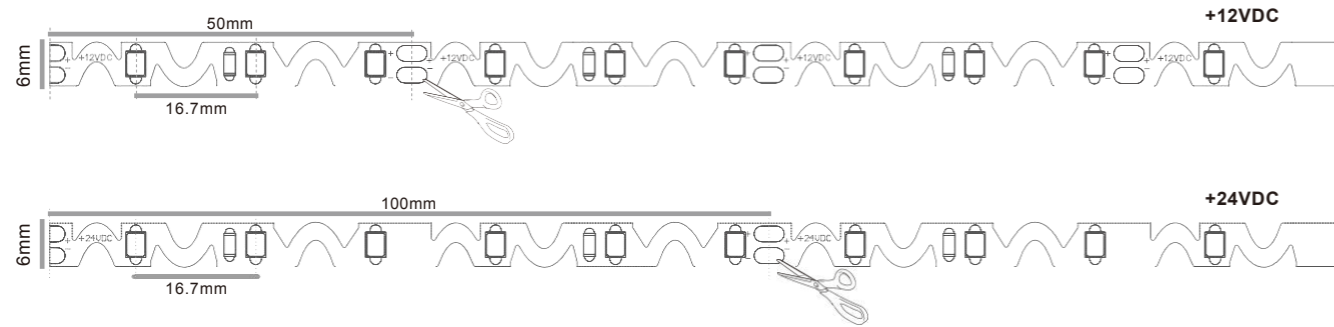

Strip length: CE: 300CM UL: 9.8FT(12V) | 9.8FT(24V)



### IP Rating:

- IP20---Non waterproof 
- IP54---Nano coated 

## S Type(Bendable)

Part Number:ES-FS3528C-60-12-Y(S)  
Part Number:ES-FS3528C-60-24-Y(S)

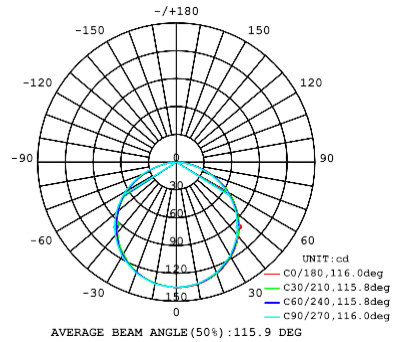
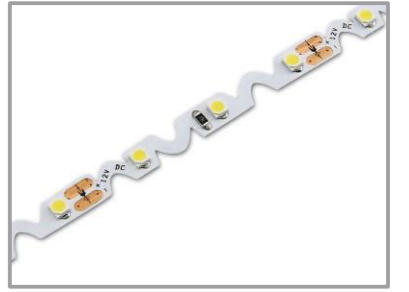

Model	Color temp. Wave lengths	LM/M	Power/M	CRI (Ra)	FPC copper
ES-FS3528WW-60-24-Y(S)	2700K	360LM	<4.8W	90+	2OZ
ES-FS3528WW-60-24-Y(S)	3000K	360LM	<4.8W	90+	2OZ
ES-FS3528WW-60-24-Y(S)	3500K	390LM	<4.8W	90+	2OZ
ES-FS3528NW-60-24-Y(S)	4000K	390LM	<4.8W	90+	2OZ
ES-FS3528NW-60-24-Y(S)	5000K	390LM	<4.8W	90+	2OZ
ES-FS3528PW-60-24-Y(S)	6500K	400LM	<4.8W	90+	2OZ
ES-FS3528R-60-24-Y(S)	620-625 NM NM	---	<4.8W	---	2OZ
ES-FS3528Y-60-24-Y(S)	585-590 NM NM	---	<4.8W	---	2OZ
ES-FS3528G-60-24-Y(S)	517-522 NM NM	---	<4.8W	---	2OZ
ES-FS3528B-60-24-Y(S)	465-470 NM NM	---	<4.8W	---	2OZ

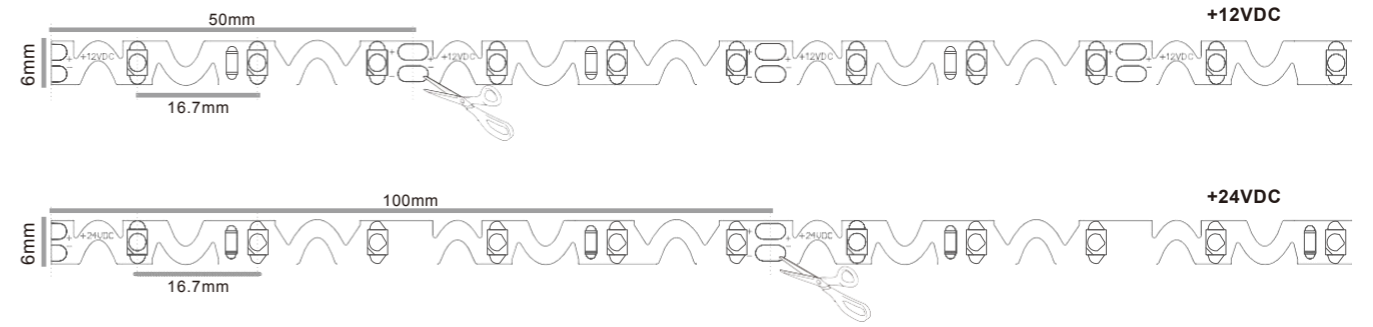

Strip length: CE: 500CM UL: 16.4FT(12V) | 16.4FT(24V)



### IP Rating:

- IP20---Non waterproof 
- IP54---Nano coated 



# ES-FS3014C-120-24-Y (Side View)

①

②

③

④

⑤

## Side View(Bendable)

### LED Tape Light

#### Product Features

1. Flexible LED strip with side light exit.
2. Use SMD3014 source which stronger than traditional SMD335 source.
3. Performance more stable and reliable than SMD335 side view LED strip.

**Color**

**Input DC Voltage**  
24VDC | 12VDC



**LED Type**  
SMD3014

3000 K	4000 K	5000 K	6500 K
-----------	-----------	-----------	-----------

**LED Qty.per meter**  
120 | 60

**IP Index**  
IP 20 | IP54 | IP67

LED Strip Light

LED Strip Light Accessory

Aluminum Profile

LED Linear Luminaire

LED Panel Light

LED Panel Light Accessory

LED Strip Light

LED Strip Light Accessory

Aluminum Profile

LED Linear Luminaire

LED Panel Light

LED Panel Light Accessory

## Side View

Part Number:ES-FS3014C-120-24-Y(Side View)  
Part Number:ES-FS3014C-120-12-Y(Side View)

Model	Color temp. Wave lengths	LM/M	Power/M	CRI (Ra)	FPC copper
ES-FS3014WW-120-24-Y	3000K	864LM	<9.6W	80+	3OZ
ES-FS3014NW-120-24-Y	4000K	915LM	<9.6W	80+	3OZ
ES-FS3014NW-120-24-Y	5000K	915LM	<9.6W	80+	3OZ
ES-FS3014PW-120-24-Y	6500K	915LM	<9.6W	80+	3OZ
ES-FS3014R-120-24-Y	620-625 NM NM	---	<9.6W	---	3OZ
ES-FS3014Y-120-24-Y	585-590 NM NM	---	<9.6W	---	3OZ
ES-FS3014G-120-24-Y	517-522 NM NM	---	<9.6W	---	3OZ
ES-FS3014B-120-24-Y	465-470 NM NM	---	<9.6W	---	3OZ

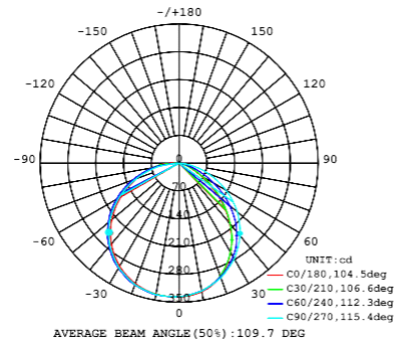
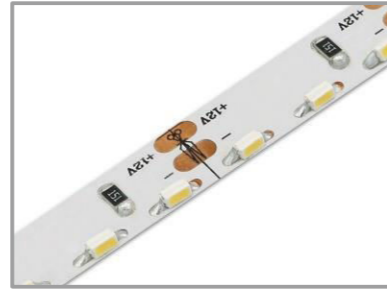

Strip length: CE: 500CM UL: 16.4FT

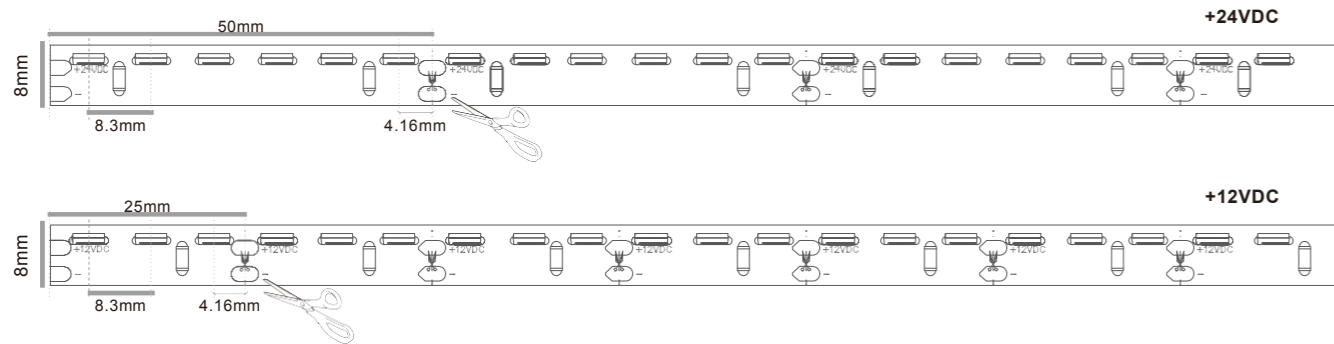

Aluminum Profile For LED Side View LED Strip

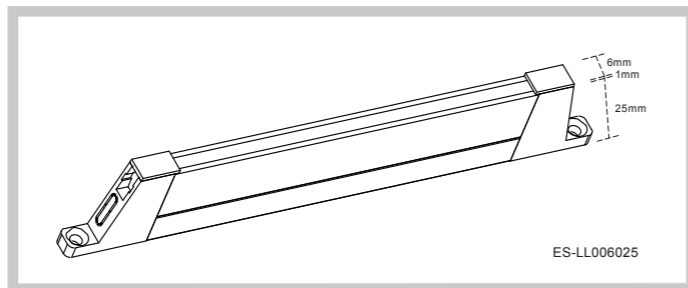

### IP Rating:

- IP20---Non waterproof
- IP54---Nano coated
- IP67---Silicon tube(transparent)

## Side View

Part Number:ES-FS3014C-60-24-Y(Side View)  
Part Number:ES-FS3014C-60-12-Y(Side View)

Model	Color temp. Wave lengths	LM/M	Power/M	CRI (Ra)	FPC copper
ES-FS3014WW-60-24-Y	3000K	360LM	<4.8W	80+	2OZ
ES-FS3014NW-60-24-Y	4000K	390LM	<4.8W	80+	2OZ
ES-FS3014NW-60-24-Y	5000K	390LM	<4.8W	80+	2OZ
ES-FS3014PW-60-24-Y	6500K	400LM	<4.8W	80+	2OZ
ES-FS3014R-60-24-Y	620-625 NM NM	---	<4.8W	---	2OZ
ES-FS3014Y-60-24-Y	585-590 NM NM	---	<4.8W	---	2OZ
ES-FS3014G-60-24-Y	517-522 NM NM	---	<4.8W	---	2OZ
ES-FS3014B-60-24-Y	465-470 NM NM	---	<4.8W	---	2OZ

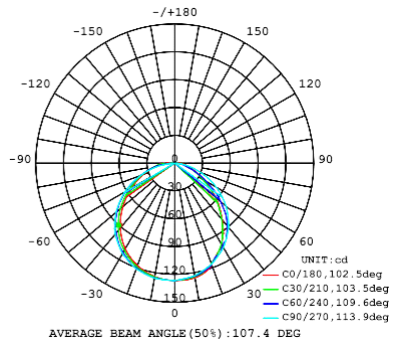

Strip length: CE: 500CM UL: 16.4FT

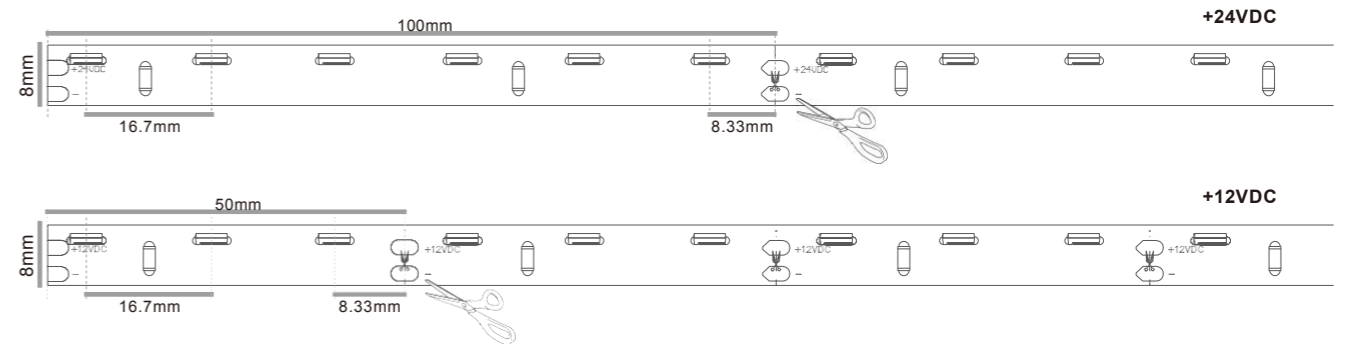

Aluminum Profile For LED Side View LED Strip

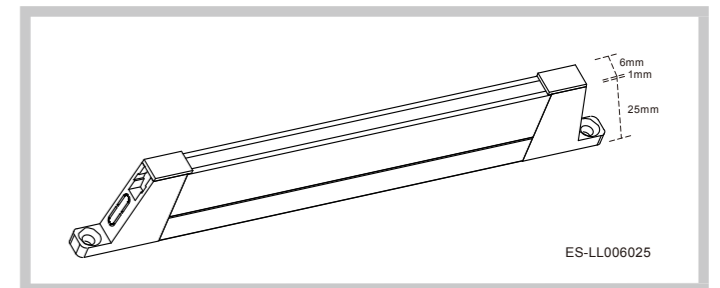

### IP Rating:

- IP20---Non waterproof
- IP54---Nano coated
- IP67---Silicon tube(transparent)

# Side View

## Part Number:ES-FS3014RGB-120-24-Y(Side View)

Model	Wave lengths	LM/M	Power/M	FPC copper
ES-FS3014RGB-120-24-Y	620-625 NM NM	535LM	<23W	30Z
	517-522 NM NM			
	465-470 NM NM			



### Controller

Product No.	Description
4.02.127	12-24VDC 3A*3CH Max.9A 108W/216W(12V/24V)

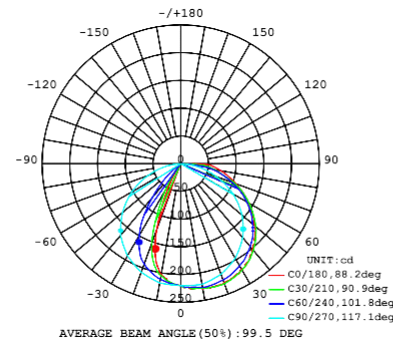

Strip length: CE: 500CM UL: 16.4FT

+24VDC

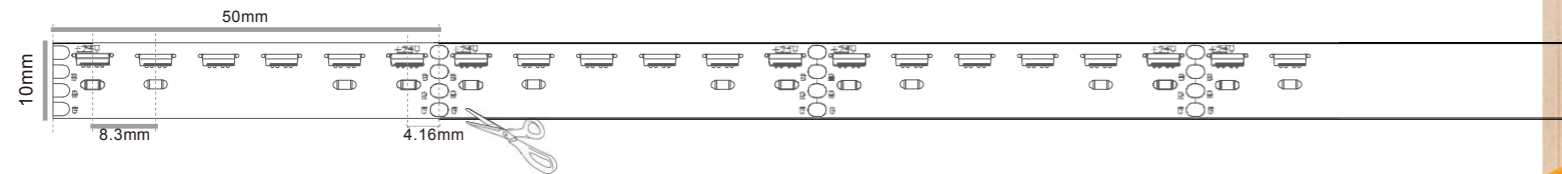

### Aluminum Profile For LED Side View LED Strip

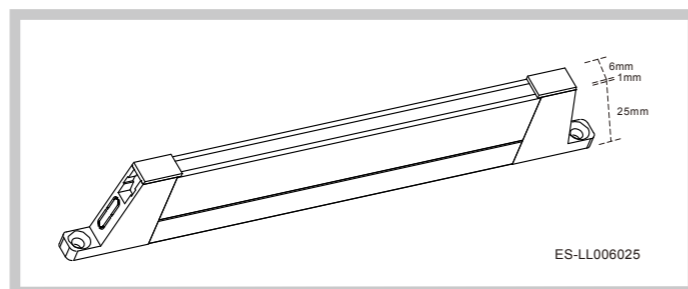

### IP Rating:

- IP20---Non waterproof
- IP54---Nano coated
- IP67---Silicon tube(transparent)



LED Strip Light

LED Strip Light Accessory

Aluminum Profile

LED Linear Luminaire

LED Panel Light

LED Panel Light Accessory

LED Strip Light

LED Strip Light Accessory

Aluminum Profile

LED Linear Luminaire

LED Panel Light

LED Panel Light Accessory

# 3D(Bendable)

## LED Tape Light

### Product Features

- 1. 3D led strip - 90-180 angle bend application.
- 2. RA 90+(SMD3528) and RA 94+(SMD2835) for option.
- 3. IP20 and IP67 protection.

# ES-FS3528C-120-24-Y(3D)

① ② ③ ④ ⑤



**Color**

**Input DC Voltage**  
24VDC

**LED Type**  
SMD3528

**LED Qty. per meter**  
120

**IP Index**  
IP20 | IP67

2700 K	3000 K	3500 K
4000 K	5000 K	6500 K

# 3D LED Tape Light(Bendable)

Part Number:ES-FS3528C-120-24-Y(3D)

Model	Color temp. Wave lengths	LM/M	Power/M	CRI (Ra)	FPC copper
ES-FS3528WW-120-24-Y(3D)	2700K	740LM	<9. 6W	90+	3OZ
ES-FS3528WW-120-24-Y(3D)	3000K	740LM	<9. 6W	90+	3OZ
ES-FS3528WW-120-24-Y(3D)	3500K	740LM	<9. 6W	90+	3OZ
ES-FS3528NW-120-24-Y(3D)	4000K	768LM	<9. 6W	90+	3OZ
ES-FS3528PW-120-24-Y(3D)	6500K	780LM	<9. 6W	90+	3OZ

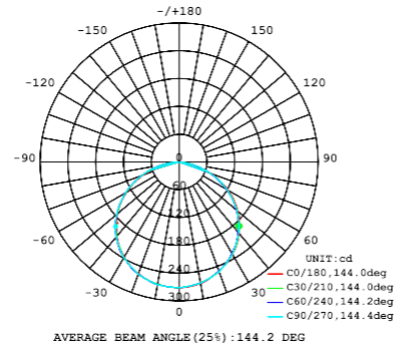

ES-FS3014R-120-24-Y(3D)	620-625 NM NM	---	<9. 6W	---	3OZ
ES-FS3014Y-120-24-Y(3D)	585-590 NM NM	---	<9. 6W	---	3OZ
ES-FS3014G-120-24-Y(3D)	517-522 NM NM	---	<9. 6W	---	3OZ
ES-FS3014B-120-24-Y(3D)	465-470 NM NM	---	<9. 6W	---	3OZ

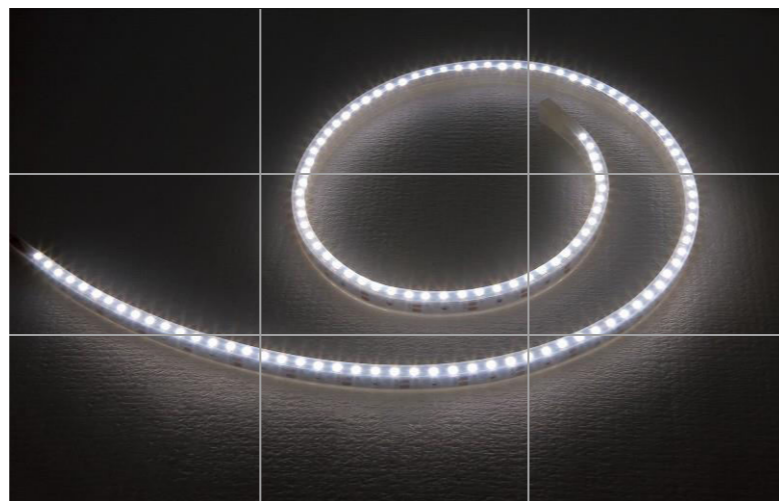
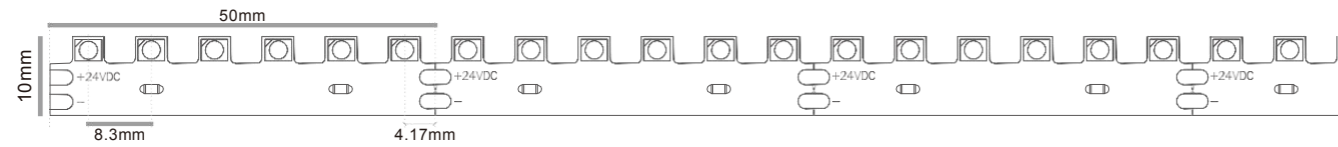

Strip length: CE: 500CM UL: 16.4FT



IP Rating:

- IP20---Non waterproof 
- IP67---Silicon tube(transparent) 

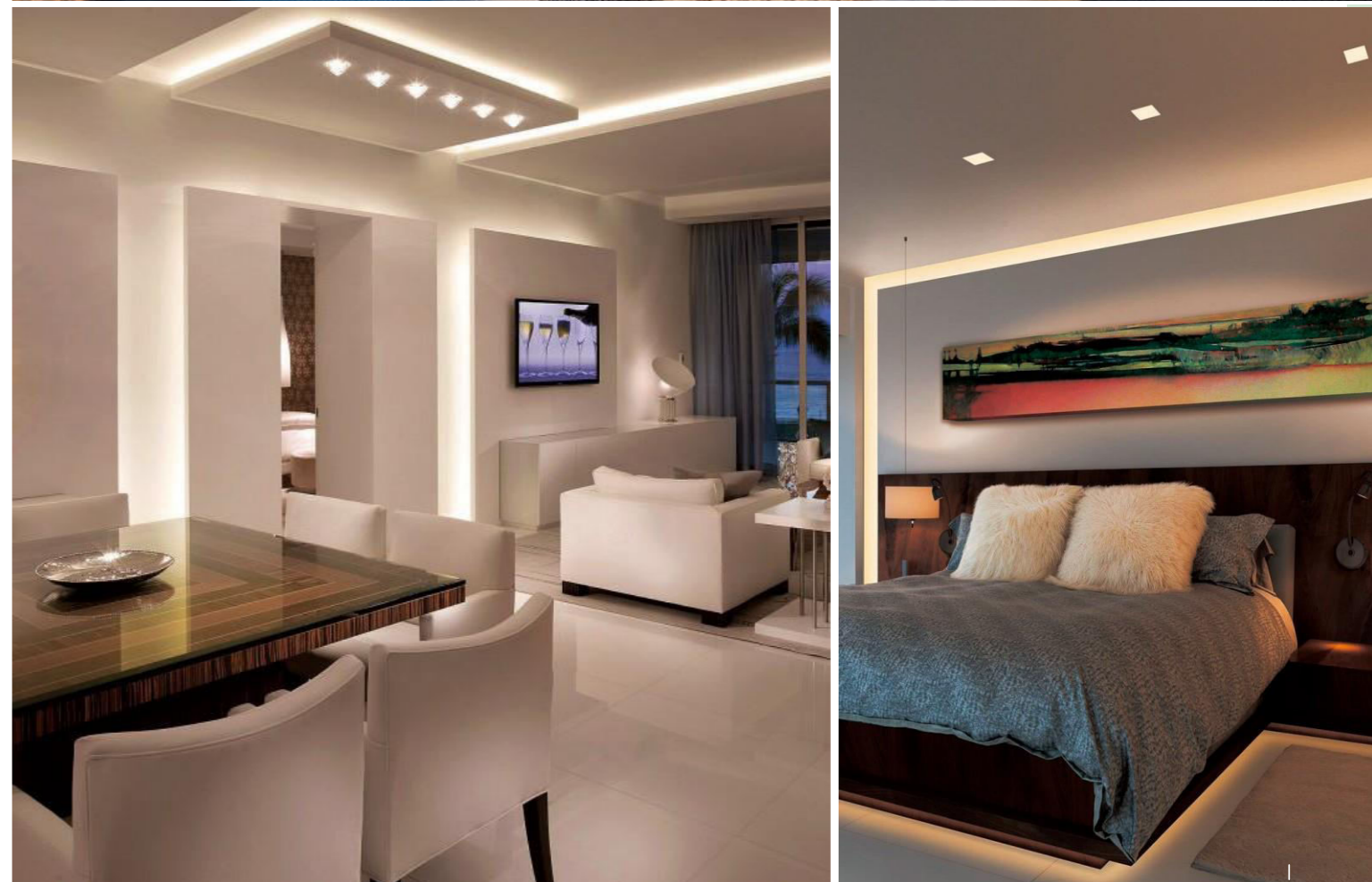

LED Strip Light

LED Strip Light Accessory

Aluminum Profile

LED Linear Luminaire

LED Panel Light

LED Panel Light Accessory

LED Strip Light

LED Strip Light Accessory

Aluminum Profile

LED Linear Luminaire

LED Panel Light

LED Panel Light Accessory

# Multi-rows LED Tape Light

Part Number: ES-FS2835C-480-24-Y

7 years warranty Ra 94+

Model	Color temp.	LM/M	Power/M	Light efficiency	CRI (Ra)	FPC copper
ES-FS2835WW-480-24-Y	1800K	2600LM	<30W	85LM/W	94+	20Z
ES-FS2835WW-480-24-Y	2100K	2600LM	<30W	85LM/W	94+	20Z
ES-FS2835WW-480-24-Y	2300K	2800LM	<30W	90LM/W	94+	20Z
ES-FS2835WW-480-24-Y	2700K	3000LM	<30W	100LM/W	94+	20Z
ES-FS2835WW-480-24-Y	3000K	3100LM	<30W	100LM/W	94+	20Z
ES-FS2835WW-480-24-Y	3500K	3200LM	<30W	105LM/W	94+	20Z
ES-FS2835NW-480-24-Y	4000K	3300LM	<30W	110LM/W	94+	20Z
ES-FS2835NW-480-24-Y	5000K	3300LM	<30W	110LM/W	94+	20Z
ES-FS2835PW-480-24-Y	6500K	3350LM	<30W	100LM/W	94+	20Z

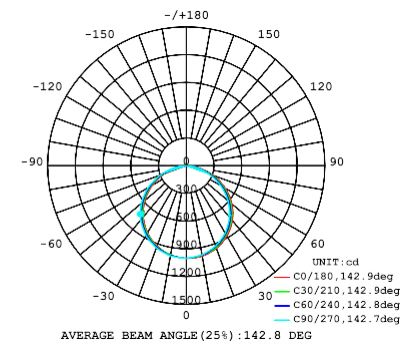

3 years warranty Ra 82+

Model	Color temp.	LM/M	Power/M	Light efficiency	CRI (Ra)	FPC copper
ES-FS2835WW-480-24-Y	3000K	3800LM	<30W	125LM/W	82+	20Z
ES-FS2835WW-480-24-Y	3500K	3850LM	<30W	125LM/W	82+	20Z
ES-FS2835NW-480-24-Y	4000K	4000LM	<30W	130LM/W	82+	20Z
ES-FS2835NW-480-24-Y	5000K	4200LM	<30W	140LM/W	82+	20Z
ES-FS2835PW-480-24-Y	6500K	4200LM	<30W	140LM/W	82+	20Z

## AL. profiles

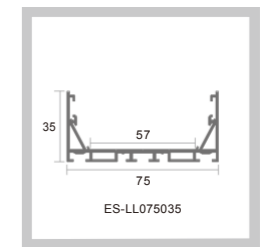

Strip length: CE:500CM UL:10.92FT

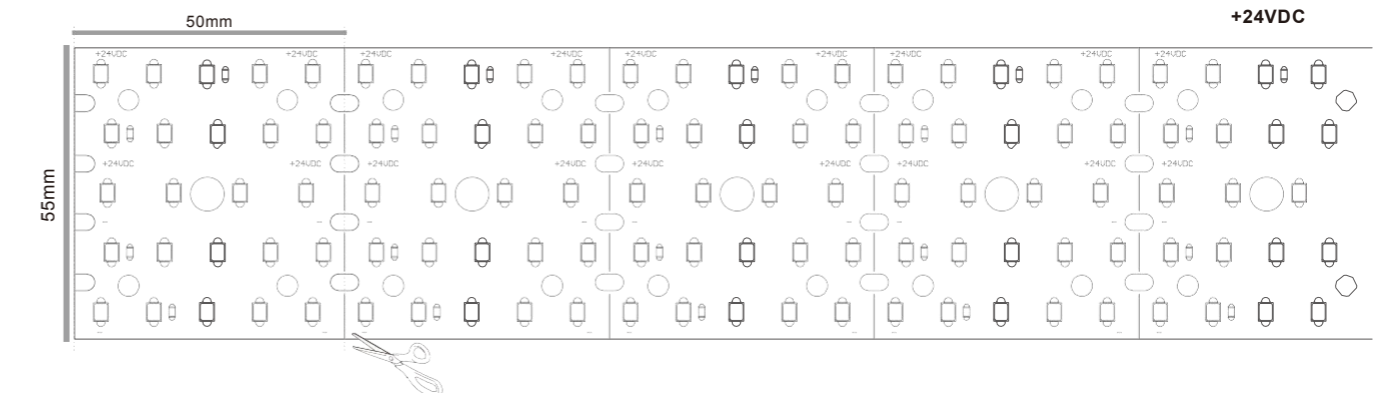

# Multi-rows

RA 94+ SMD2835 Series  
RA 82+ SMD2835 Series

## Product Features

1. Constant voltage 24VDC.
2. High Light Efficiency 140 LM/W(Ra 82+) and 110 LM/W(Ra 94+).
3. LED Strip width 20mm,30mm and 55 mm for option.
4. Suitable for our aluminum profile width:35mm,50mm,75mm.

LED Strip Light

LED Strip Light Accessory

Aluminum Profile

LED Linear Luminaire

LED Panel Light

LED Panel Light Accessory

LED Strip Light

LED Strip Light Accessory

Aluminum Profile

LED Linear Luminaire

LED Panel Light

LED Panel Light Accessory

# Multi-rows LED Tape Light

Part Number:ES-FS2835C-320-24-Y

7 years warranty Ra 94+

Model	Color temp.	LM/M	Power/M	Light efficiency	CRI (Ra)	FPC copper
ES-FS2835WW-320-24-Y	1800K	2100LM	<25W	85LM/W	94+	2OZ
ES-FS2835WW-320-24-Y	2100K	2100LM	<25W	85LM/W	94+	2OZ
ES-FS2835WW-320-24-Y	2300K	2250LM	<25W	90LM/W	94+	2OZ
ES-FS2835WW-320-24-Y	2700K	2500LM	<25W	100LM/W	94+	2OZ
ES-FS2835WW-320-24-Y	3000K	2500LM	<25W	100LM/W	94+	2OZ
ES-FS2835WW-320-24-Y	3500K	2600LM	<25W	105LM/W	94+	2OZ
ES-FS2835NW-320-24-Y	4000K	2750LM	<25W	110LM/W	94+	2OZ
ES-FS2835NW-320-24-Y	5000K	2750LM	<25W	110LM/W	94+	2OZ
ES-FS2835PW-320-24-Y	6500K	2800LM	<25W	110LM/W	94+	2OZ



ES-FS2835WW-160-24-Y  
ES-FS2835WW-160-24-Y  
ES-FS2835WW-160-24-Y

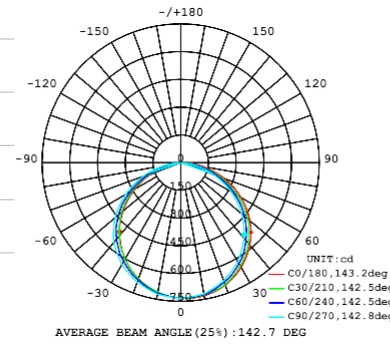

3 years warranty Ra 82+

Model	Color temp.	LM/M	Power/M	Light efficiency	CRI (Ra)	FPC copper
ES-FS2835WW-320-24-Y	3000K	3100LM	<25W	125LM/W	82+	2OZ
ES-FS2835WW-320-24-Y	3500K	3100LM	<25W	125LM/W	82+	2OZ
ES-FS2835NW-320-24-Y	4000K	3250LM	<25W	130LM/W	82+	2OZ
ES-FS2835NW-320-24-Y	5000K	3500LM	<25W	140LM/W	82+	2OZ
ES-FS2835PW-320-24-Y	6500K	3500LM	<25W	140LM/W	82+	2OZ

### AL. profiles

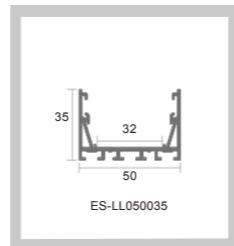

Strip length: CE:500CM UL:13.16FT

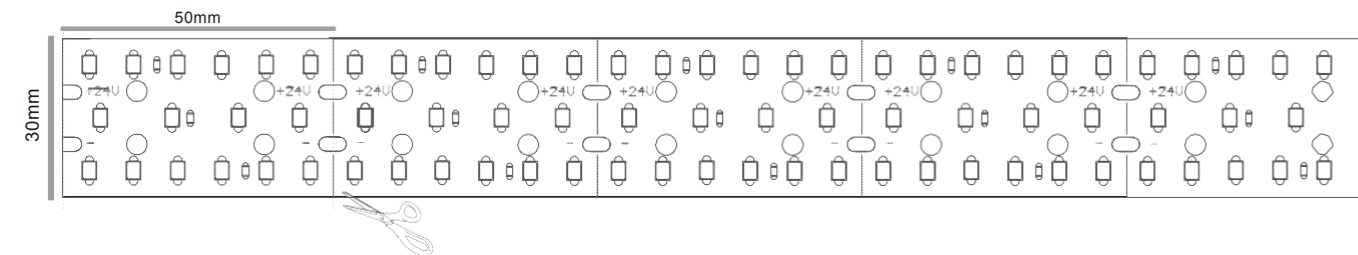

# Multi-rows LED Tape Light

Part Number:ES-FS2835C-160-24-Y

7 years warranty Ra 94+

Model	Color temp.	LM/M	Power/M	Light efficiency	CRI (Ra)	FPC copper
ES-FS2835WW-160-24-Y	1800K	1700LM	<20W	85LM/W	94+	2OZ
ES-FS2835WW-160-24-Y	2100K	1700LM	<20W	85LM/W	94+	2OZ
ES-FS2835WW-160-24-Y	2300K	1800LM	<20W	90LM/W	94+	2OZ
ES-FS2835WW-160-24-Y	2700K	2000LM	<20W	100LM/W	94+	2OZ
ES-FS2835WW-160-24-Y	3000K	2000LM	<20W	100LM/W	94+	2OZ
ES-FS2835WW-160-24-Y	3500K	2100LM	<20W	105LM/W	94+	2OZ
ES-FS2835NW-160-24-Y	4000K	2200LM	<20W	110LM/W	94+	2OZ
ES-FS2835NW-160-24-Y	5000K	2200LM	<20W	110LM/W	94+	2OZ
ES-FS2835PW-160-24-Y	6500K	2250LM	<20W	112LM/W	94+	2OZ

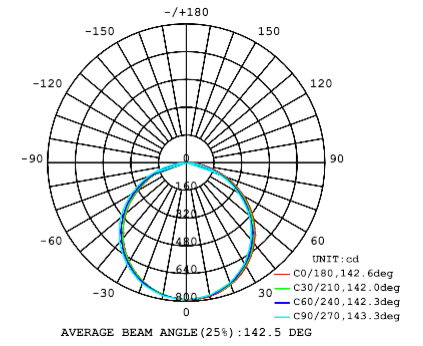
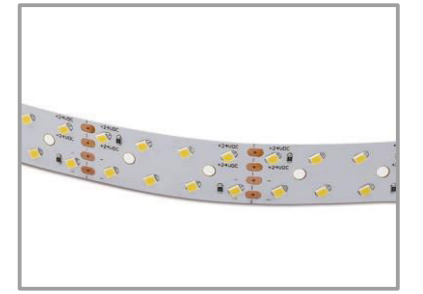

3 years warranty Ra 82+

Model	Color temp.	LM/M	Power/M	Light efficiency	CRI (Ra)	FPC copper
ES-FS2835WW-160-24-Y	3000K	2500LM	<20W	125LM/W	82+	2OZ
ES-FS2835WW-160-24-Y	3500K	2500LM	<20W	125LM/W	82+	2OZ
ES-FS2835NW-160-24-Y	4000K	2600LM	<20W	130LM/W	82+	2OZ
ES-FS2835NW-160-24-Y	5000K	2800LM	<20W	140LM/W	82+	2OZ
ES-FS2835PW-160-24-Y	6500K	2800LM	<20W	140LM/W	82+	2OZ

### AL. profiles

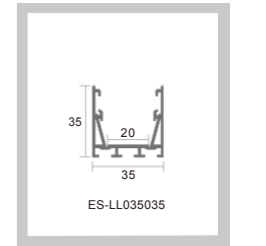

Strip length: CE:500CM UL:16.4FT

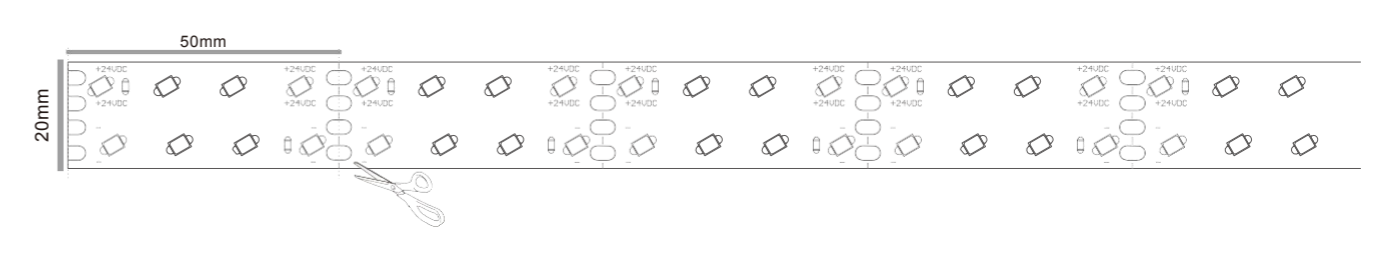

# Super Slim

## Slim 4mm LED Tape Light

### Product Features

1. Slim 4mm LED tape light, use SMD2216 LED.
2. High light efficiency as 99LM/W for 7LEDs design and 85LM/W for 6LEDs design.
3. IP20 and IP54 protection.

# ES-FS2216C-266H-24-Y

①

②

③

④

⑤

1

**LED Type**  
SMD2216

1800 K	2100 K	2300 K	2700 K	3000 K
3500 K	4000 K	5000 K	6500 K	

2

**Color**

3

**LED Qty. per meter**  
266 | 264 | 182 | 180  
120 | 112

4

**Input DC Voltage**  
24VDC

5

**IP Index**  
IP 20 | IP 54 | IP 65  
IP 67 | IP 68

Model	Color temp.	Chip Size (mil)	Luminous Flux@20mA		I <sub>F</sub>		CRI(Ra)
			Min.	Max.	Current	Max.	
SMD2216 	1800K	8x15	7LM	9LM	---	20mA	90+
	2100K	8x15	7LM	9LM	---	20mA	90+
	2300K	8x15	7LM	9LM	---	20mA	90+
	2700K	8x15	7LM	9LM	---	20mA	90+
	3000K	8x15	7LM	9LM	---	20mA	90+
	3500K	8x15	7LM	9LM	---	20mA	90+
	4000K	8x15	7LM	9LM	---	20mA	90+
	5000K	8x15	7LM	9LM	---	20mA	90+
	6500K	8x15	7LM	9LM	---	20mA	90+

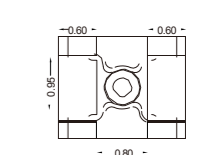
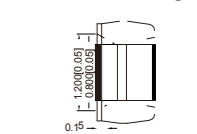
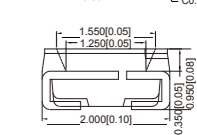
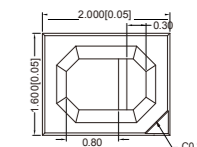



# Super Slim 4mm

Part Number:ES-FS2216C-266H-24-Y

Model	Color temp.	LM/M	Power/M	Light efficiency	CRI (Ra)	FPC copper
ES-FS2216WW-266H-24-Y	1800K	950LM	<12W	79LM/W	90+	3OZ
ES-FS2216WW-266H-24-Y	2100K	1000LM	<12W	83LM/W	90+	3OZ
ES-FS2216WW-266H-24-Y	2300K	1000LM	<12W	83LM/W	90+	3OZ
ES-FS2216WW-266H-24-Y	2700K	1050LM	<12W	87LM/W	90+	3OZ
ES-FS2216WW-266H-24-Y	3000K	1050LM	<12W	87LM/W	90+	3OZ
ES-FS2216WW-266H-24-Y	3500K	1050LM	<12W	87LM/W	90+	3OZ
ES-FS2216NW-266H-24-Y	4000K	1200LM	<12W	100LM/W	90+	3OZ
ES-FS2216NW-266H-24-Y	5000K	1200LM	<12W	100LM/W	90+	3OZ
ES-FS2216PW-266H-24-Y	6500K	1200LM	<12W	100LM/W	90+	3OZ

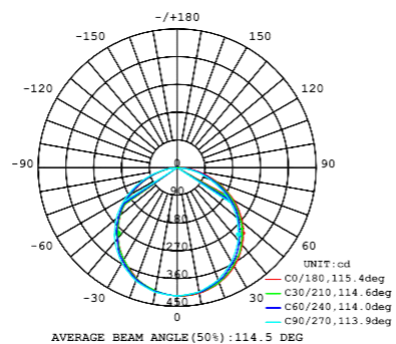

Strip length: CE:500CM UL:16.4FT

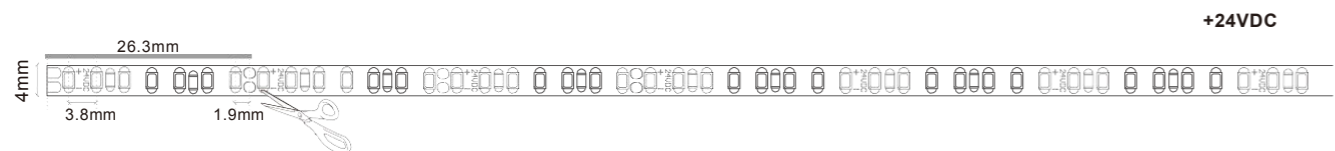

### AL. profiles (mm)

ES-LL017009	ES-LL024011	ES-LL017015	ES-LL013006
ES-LL023009	ES-LL030011	ES-LL023015	ES-LL013012
ES-LL016016	ES-LL020020-1	ES-LL025019	ES-LL025025
ES-LL030030	ES-LL010015	ES-LL025046	
ES-LL057011	ES-LL064014		

### IP Rating:

- IP20---Non waterproof
- IP54---Nano coated



# Super Slim 4mm

Part Number:ES-FS2216C-182H-24-Y

Model	Color temp.	LM/M	Power/M	Light efficiency	CRI (Ra)	FPC copper
ES-FS2216WW-182H-24-Y	1800K	690LM	<9W	76LM/W	90+	3OZ
ES-FS2216WW-182H-24-Y	2100K	720LM	<9W	80LM/W	90+	3OZ
ES-FS2216WW-182H-24-Y	2300K	720LM	<9W	80LM/W	90+	3OZ
ES-FS2216WW-182H-24-Y	2700K	780LM	<9W	86LM/W	90+	3OZ
ES-FS2216WW-182H-24-Y	3000K	780LM	<9W	86LM/W	90+	3OZ
ES-FS2216WW-182H-24-Y	3500K	780LM	<9W	86LM/W	90+	3OZ
ES-FS2216NW-182H-24-Y	4000K	850LM	<9W	94LM/W	90+	3OZ
ES-FS2216NW-182H-24-Y	5000K	850LM	<9W	94LM/W	90+	3OZ
ES-FS2216PW-182H-24-Y	6500K	850LM	<9W	94LM/W	90+	3OZ

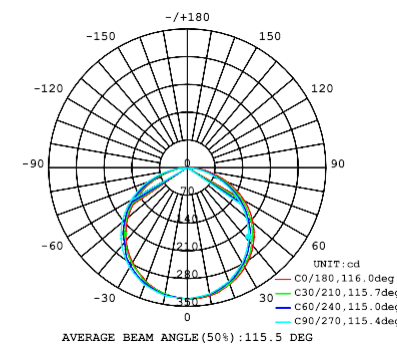

Strip length: CE:500CM UL:16.4FT

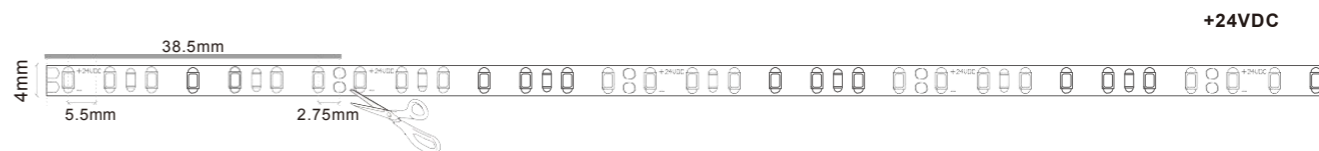

### AL. profiles (mm)

ES-LL017009	ES-LL024011	ES-LL017015	ES-LL013006
ES-LL023009	ES-LL030011	ES-LL023015	ES-LL013012
ES-LL016016	ES-LL020020-1	ES-LL025019	ES-LL025025
ES-LL030030	ES-LL010015	ES-LL025046	
ES-LL057011	ES-LL064014		

### IP Rating:

- IP20---Non waterproof
- IP54---Nano coated



# Super Slim 4mm

## Part Number:ES-FS2216C-112-24-Y

Model	Color temp.	LM/M	Power/M	Light efficiency	CRI (Ra)	FPC copper
ES-FS2216WW-112-24-Y	1800K	570LM	<7.2W	79LM/W	90+	3OZ
ES-FS2216WW-112-24-Y	2100K	600LM	<7.2W	83LM/W	90+	3OZ
ES-FS2216WW-112-24-Y	2300K	600LM	<7.2W	83LM/W	90+	3OZ
ES-FS2216WW-112-24-Y	2700K	620LM	<7.2W	86LM/W	90+	3OZ
ES-FS2216WW-112-24-Y	3000K	620LM	<7.2W	86LM/W	90+	3OZ
ES-FS2216WW-112-24-Y	3500K	620LM	<7.2W	86LM/W	90+	3OZ
ES-FS2216NW-112-24-Y	4000K	680LM	<7.2W	94LM/W	90+	3OZ
ES-FS2216NW-112-24-Y	5000K	680LM	<7.2W	94LM/W	90+	3OZ
ES-FS2216PW-112-24-Y	6500K	680LM	<7.2W	94LM/W	90+	3OZ

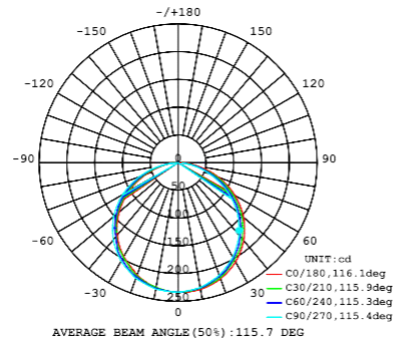

Strip length: CE:500CM UL:16.4FT

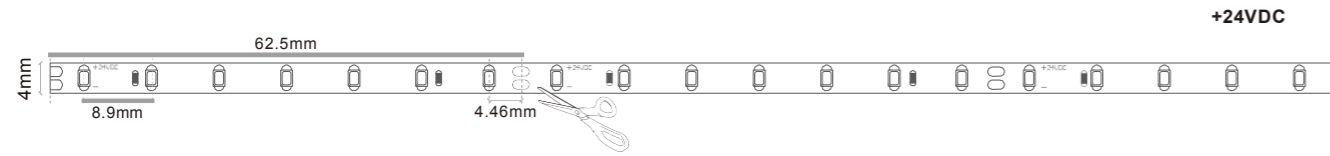

### AL. profiles (mm)

ES-LL017009	ES-LL024011	ES-LL017015	ES-LL013006
ES-LL023009	ES-LL030011	ES-LL023015	ES-LL013012
ES-LL016016	ES-LL020020-1	ES-LL025019	ES-LL025025
ES-LL030030	ES-LL010015	ES-LL025048	
ES-LL057011	ES-LL064014		

### IP Rating:

- IP20---Non waterproof
- IP54---Nano coated



# Super Slim 4mm

## Part Number:ES-FS2216C-264-24-Y

Model	Color temp.	LM/M	Power/M	CRI (Ra)	FPC copper
ES-FS2216WW-264H-24-Y	1800K	850LM	<12W	90+	3OZ
ES-FS2216WW-264H-24-Y	2100K	900LM	<12W	90+	3OZ
ES-FS2216WW-264H-24-Y	2300K	900LM	<12W	90+	3OZ
ES-FS2216WW-264H-24-Y	2700K	952LM	<12W	90+	3OZ
ES-FS2216WW-264H-24-Y	3000K	952LM	<12W	90+	3OZ
ES-FS2216WW-264H-24-Y	3500K	952LM	<12W	90+	3OZ
ES-FS2216NW-264H-24-Y	4000K	980LM	<12W	90+	3OZ
ES-FS2216NW-264H-24-Y	5000K	980LM	<12W	90+	3OZ
ES-FS2216PW-264H-24-Y	6500K	1010LM	<12W	90+	3OZ

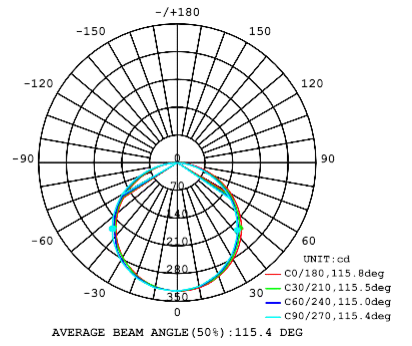

Strip length: CE:500CM UL:16.4FT

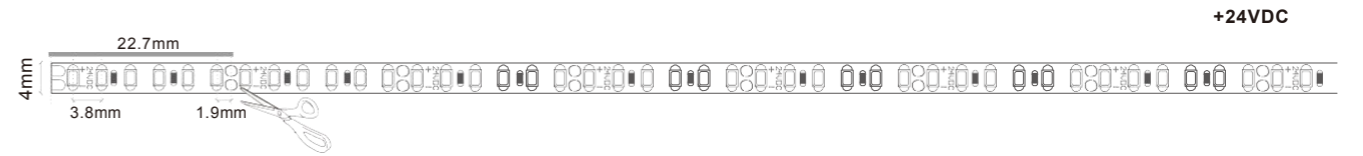

### AL. profiles (mm)

ES-LL017009	ES-LL024011	ES-LL017015	ES-LL013006
ES-LL023009	ES-LL030011	ES-LL023015	ES-LL013012
ES-LL016016	ES-LL020020-1	ES-LL025019	ES-LL025025
ES-LL030030	ES-LL010015	ES-LL025048	
ES-LL057011	ES-LL064014		

### IP Rating:

- IP20---Non waterproof
- IP54---Nano coated



# Super Slim 4mm

Part Number:ES-FS2216C-180-24-Y

Model	Color temp.	LM/M	Power/M	CRI (Ra)	FPC copper
ES-FS2216WW-180-24-Y	1800K	600LM	<9W	90+	3OZ
ES-FS2216WW-180-24-Y	2100K	630LM	<9W	90+	3OZ
ES-FS2216WW-180-24-Y	2300K	630LM	<9W	90+	3OZ
ES-FS2216WW-180-24-Y	2700K	680LM	<9W	90+	3OZ
ES-FS2216WW-180-24-Y	3000K	680LM	<9W	90+	3OZ
ES-FS2216WW-180-24-Y	3500K	680LM	<9W	90+	3OZ
ES-FS2216NW-180-24-Y	4000K	760LM	<9W	90+	3OZ
ES-FS2216NW-180-24-Y	5000K	760LM	<9W	90+	3OZ
ES-FS2216PW-180-24-Y	6500K	778LM	<9W	90+	3OZ

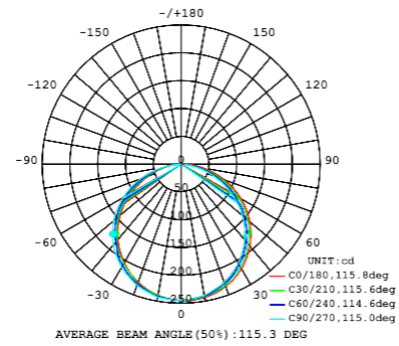

Strip length: CE:500CM UL:16.4FT

+24VDC

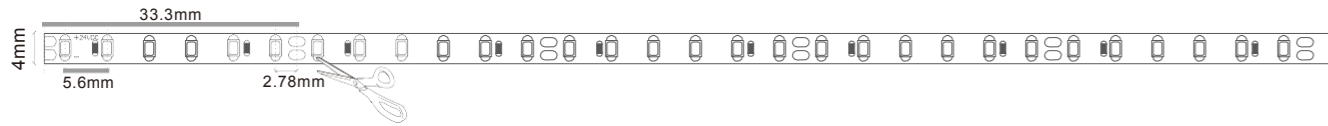

AL. profiles (mm)

ES-LL017009	ES-LL024011	ES-LL017015	ES-LL013006
ES-LL023009	ES-LL030011	ES-LL023015	ES-LL013012
ES-LL016016	ES-LL020020-1	ES-LL025019	ES-LL025025
ES-LL030030	ES-LL010015	ES-LL025046	
ES-LL057011	ES-LL064014		

IP Rating:

- IP20---Non waterproof
- IP54---Nano coated



# Super Slim 4mm

Part Number:ES-FS2216C-120-24-Y

Model	Color temp.	LM/M	Power/M	CRI (Ra)	FPC copper
ES-FS2216WW-120-24-Y	1800K	500LM	<7.2W	90+	3OZ
ES-FS2216WW-120-24-Y	2100K	540LM	<7.2W	90+	3OZ
ES-FS2216WW-120-24-Y	2300K	540LM	<7.2W	90+	3OZ
ES-FS2216WW-120-24-Y	2700K	573LM	<7.2W	90+	3OZ
ES-FS2216WW-120-24-Y	3000K	573LM	<7.2W	90+	3OZ
ES-FS2216WW-120-24-Y	3500K	573LM	<7.2W	90+	3OZ
ES-FS2216NW-120-24-Y	4000K	600LM	<7.2W	90+	3OZ
ES-FS2216NW-120-24-Y	5000K	600LM	<7.2W	90+	3OZ
ES-FS2216PW-120-24-Y	6500K	620LM	<7.2W	90+	3OZ

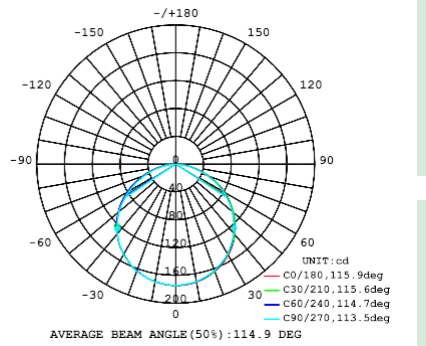

Strip length: CE:500CM UL:16.4FT

+24VDC

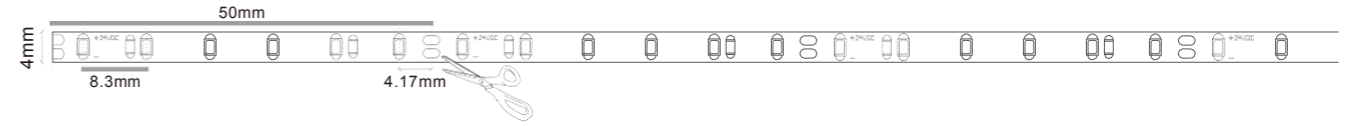

AL. profiles (mm)

ES-LL017009	ES-LL024011	ES-LL017015	ES-LL013006
ES-LL023009	ES-LL030011	ES-LL023015	ES-LL013012
ES-LL016016	ES-LL020020-1	ES-LL025019	ES-LL025025
ES-LL030030	ES-LL010015	ES-LL025046	
ES-LL057011	ES-LL064014		

IP Rating:

- IP20---Non waterproof
- IP54---Nano coated



# Super Slim

## Slim 5mm LED Tape Light

### Product Features

1. Slim 5mm LED tape light, use SMD3528 LED.
2. 60LEDs|120LEDs|180LEDs per meter for option.
3. 2700K, 3000K, 3500K, 4000K, 5000K, 6500K color temperature options.
4. IP20 and IP54 protection.

# ES-FS3528C-180H-24-Y

①

②

③

④

⑤

1

**LED Type**  
SMD3528

2700 K	3000 K	3500 K
4000 K	5000 K	6500 K

**Color**

2

**LED Qty. per meter**  
180 | 120 | 60

**Input DC Voltage**  
24VDC | 12VDC

4

**IP Index**  
IP20 | IP54

5

Model	Color temp. Wave lengths	Chip Size (mil)	Luminous Flux@20mA		I <sub>F</sub>		CRI(Ra)
			Min.	Max.	Current	Max.	
SMD3528 	2700K	8x15	7LM	9LM	20mA	30mA	90+
	3000K	8x15	7LM	9LM	20mA	30mA	90+
	3500K	8x15	7LM	9LM	20mA	30mA	90+
	4000K	8x15	7LM	9LM	20mA	30mA	90+
	5000K	8x15	7LM	9LM	20mA	30mA	90+
	6500K	8x15	7LM	9LM	20mA	30mA	90+
	620-625 NM NM	8x15	7LM	---	20mA	30mA	---
	585-590 NM NM	8x15	7LM	---	20mA	30mA	---
	517-522 NM NM	8x15	7LM	---	20mA	30mA	---
	465-470 NM NM	8x15	7LM	---	20mA	30mA	---

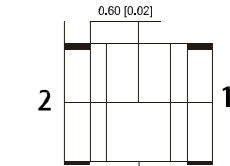
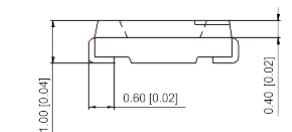
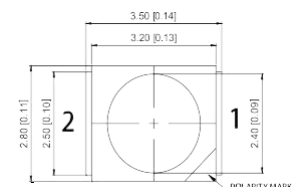

# Super Slim 5mm

## Part Number: ES-FS3528C-180H-24-Y

Model	Color temp. Wave lengths	LM/M	Power/M	CRI (Ra)	FPC copper
ES-FS3528WW-180H-24-Y	2700K	1026LM	<14.4W	90+	3OZ
ES-FS3528WW-180H-24-Y	3000K	1026LM	<14.4W	90+	3OZ
ES-FS3528WW-180H-24-Y	3500K	1026LM	<14.4W	90+	3OZ
ES-FS3528NW-180H-24-Y	4000K	1100LM	<14.4W	90+	3OZ
ES-FS3528NW-180H-24-Y	5000K	1100LM	<14.4W	90+	3OZ
ES-FS3528PW-180H-24-Y	6500K	1150LM	<14.4W	90+	3OZ
ES-FS3528R-180H-24-Y	620-625 NM NM	---	<14.4W	90+	3OZ
ES-FS3528Y-180H-24-Y	585-590 NM NM	---	<14.4W	90+	3OZ
ES-FS3528G-180H-24-Y	517-522 NM NM	---	<14.4W	90+	3OZ
ES-FS3528B-180H-24-Y	465-470 NM NM	---	<14.4W	90+	3OZ

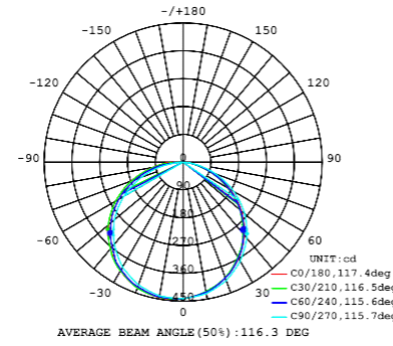

Strip length: CE:500CM UL:16.4FT

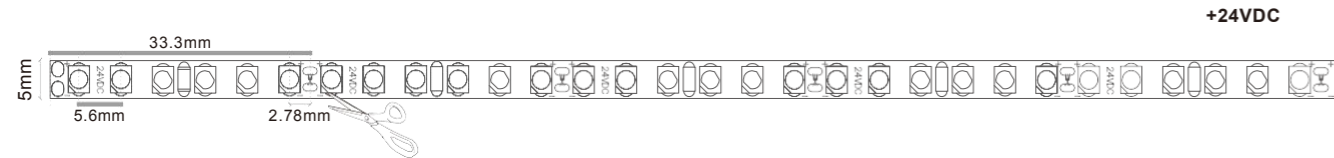

### AL. profiles (mm)

ES-LL017009	ES-LL024011	ES-LL017015	ES-LL013006
ES-LL023009	ES-LL030011	ES-LL023015	ES-LL013012
ES-LL016016	ES-LL020020-1	ES-LL025019	ES-LL025025
ES-LL030030	ES-LL010015	ES-LL025046	
ES-LL057011	ES-LL064014		

### IP Rating:

- IP20---Non waterproof
- IP54---Nano coated



# Super Slim 5mm

## Part Number: ES-FS3528C-120H-24-Y

Model	Color temp. Wave lengths	LM/M	Power/M	CRI (Ra)	FPC copper
ES-FS3528WW-120H-24-Y	2700K	740LM	<9.6W	90+	3OZ
ES-FS3528WW-120H-24-Y	3000K	740LM	<9.6W	90+	3OZ
ES-FS3528WW-120H-24-Y	3500K	740LM	<9.6W	90+	3OZ
ES-FS3528NW-120H-24-Y	4000K	768LM	<9.6W	90+	3OZ
ES-FS3528NW-120H-24-Y	5000K	768LM	<9.6W	90+	3OZ
ES-FS3528PW-120H-24-Y	6500K	780LM	<9.6W	90+	3OZ
ES-FS3528R-120H-24-Y	620-625 NM NM	---	<9.6W	90+	3OZ
ES-FS3528Y-120H-24-Y	585-590 NM NM	---	<9.6W	90+	3OZ
ES-FS3528G-120H-24-Y	517-522 NM NM	---	<9.6W	90+	3OZ
ES-FS3528B-120H-24-Y	465-470 NM NM	---	<9.6W	90+	3OZ

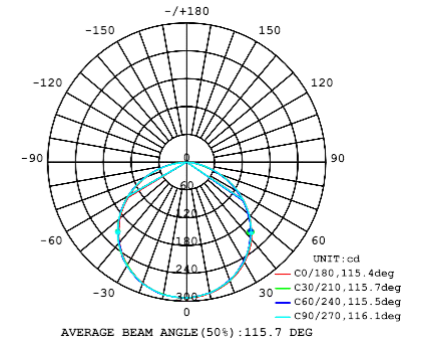

Strip length: CE:500CM UL:16.4FT

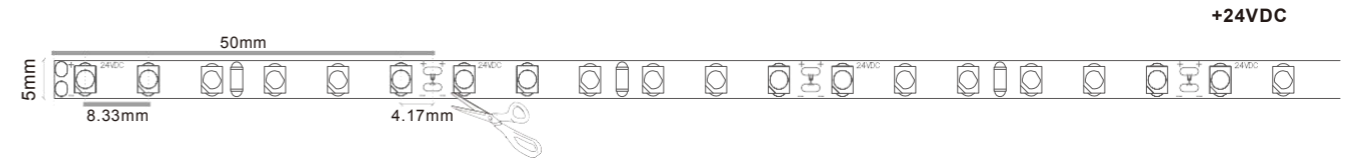

### AL. profiles (mm)

ES-LL017009	ES-LL024011	ES-LL017015	ES-LL013006
ES-LL023009	ES-LL030011	ES-LL023015	ES-LL013012
ES-LL016016	ES-LL020020-1	ES-LL025019	ES-LL025025
ES-LL030030	ES-LL010015	ES-LL025046	
ES-LL057011	ES-LL064014		

### IP Rating:

- IP20---Non waterproof
- IP54---Nano coated



# Super Slim 5mm

Part Number:ES-FS3528C-60H-12-Y  
 Part Number:ES-FS3528C-60H-24-Y

Model	Color temp. Wave lengths	LM/M	Power/M	CRI (Ra)	FPC copper
ES-FS3528WW-60H-12-Y	2700K	360LM	<4.8W	90+	3OZ(12V) 2OZ(24V)
ES-FS3528WW-60H-12-Y	3000K	360LM	<4.8W	90+	3OZ(12V) 2OZ(24V)
ES-FS3528WW-60H-12-Y	3500K	360LM	<4.8W	90+	3OZ(12V) 2OZ(24V)
ES-FS3528NW-60H-12-Y	4000K	390LM	<4.8W	90+	3OZ(12V) 2OZ(24V)
ES-FS3528NW-60H-12-Y	5000K	390LM	<4.8W	90+	3OZ(12V) 2OZ(24V)
ES-FS3528PW-60H-12-Y	6500K	400LM	<4.8W	90+	3OZ(12V) 2OZ(24V)
ES-FS3528R-60H-12-Y	620-625 NM NM	---	<4.8W	90+	3OZ(12V) 2OZ(24V)
ES-FS3528Y-60H-12-Y	585-590 NM NM	---	<4.8W	90+	3OZ(12V) 2OZ(24V)
ES-FS3528G-60H-12-Y	517-522 NM NM	---	<4.8W	90+	3OZ(12V) 2OZ(24V)
ES-FS3528B-60H-12-Y	465-470 NM NM	---	<4.8W	90+	3OZ(12V) 2OZ(24V)

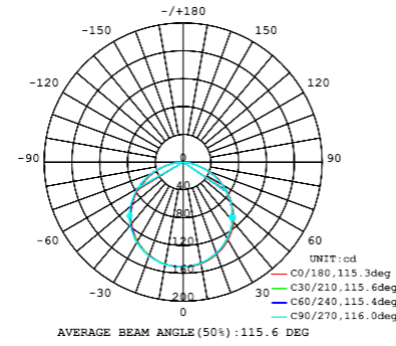

Strip length: CE:500CM UL:16.4FT(12V) | 16.4FT(24V)

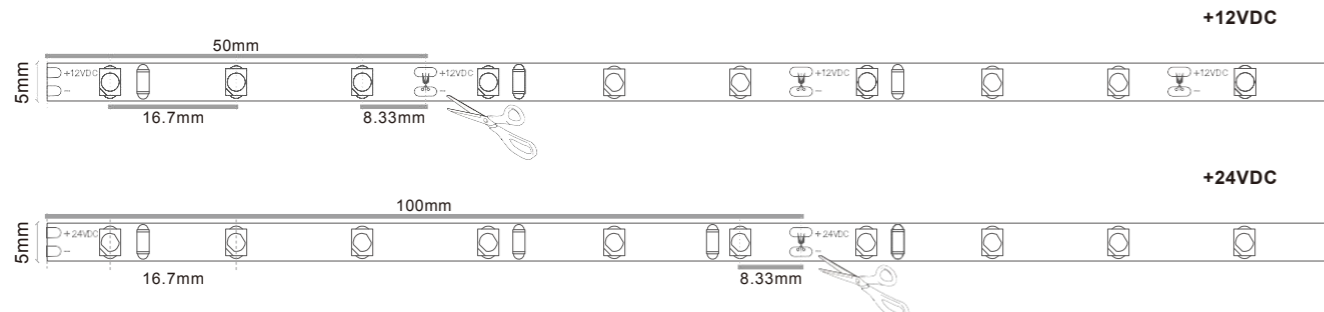

### AL. profiles (mm)

ES-LL017009	ES-LL024011	ES-LL017015	ES-LL013006
ES-LL023009	ES-LL030011	ES-LL023015	ES-LL013012
ES-LL016016	ES-LL020020-1	ES-LL025019	ES-LL025025
ES-LL030030	ES-LL010015	ES-LL025046	
ES-LL057011	ES-LL064014		

### IP Rating:

- IP20---Non waterproof
- IP54---Nano coated



LED Strip Light

LED Strip Light Accessory

Aluminum Profile

LED Linear Luminaire

LED Panel Light

LED Panel Light Accessory

LED Strip Light

LED Strip Light Accessory

Aluminum Profile

LED Linear Luminaire

LED Panel Light

LED Panel Light Accessory

# ES-FS2216C-490-24-Y

① ② ③ ④ ⑤

## High Density

RA 90+ SMD2216 Series  
RA 97+ Available

### Product Features

1. High RA 90+, RA 97+ is available, which conform to the requirement of supplementary light.
2. High density with homogeneous light.
4. Our mould of LED bracket, Stronger performance than the market.

Color

Input DC Voltage  
24VDC

LED Type  
SMD2216

LED Qty. per meter  
490 | 364 | 238 | 266  
182 | 112

IP Index  
IP 20 | IP54 | IP65  
IP67 | IP68

1800 K	2100 K	2300 K	2700 K	3000 K
3500 K	4000 K	5000 K	6500 K	

Model	Color temp.	Chip Size (mil)	Luminous Flux@20mA		I <sub>F</sub>		CRI(Ra)
			Min.	Max.	Current	Max.	
SMD2216 	1800K	8x15	7LM	9LM	---	20mA	90+
	2100K	8x15	7LM	9LM	---	20mA	90+
	2300K	8x15	7LM	9LM	---	20mA	90+
	2700K	8x15	7LM	9LM	---	20mA	90+
	3000K	8x15	7LM	9LM	---	20mA	90+
	3500K	8x15	7LM	9LM	---	20mA	90+
	4000K	8x15	7LM	9LM	---	20mA	90+
	5000K	8x15	7LM	9LM	---	20mA	90+
	6500K	8x15	7LM	9LM	---	20mA	90+

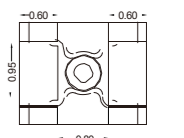
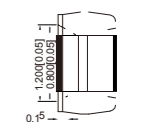
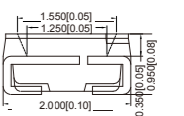
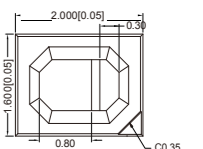

LED Strip Light

LED Strip Light Accessory

Aluminum Profile

LED Linear Luminaire

LED Panel Light

LED Panel Light Accessory

LED Strip Light

LED Strip Light Accessory

Aluminum Profile

LED Linear Luminaire

LED Panel Light

LED Panel Light Accessory

Part Number:ES-FS2216C-490-24-Y

High Density  
RA 90+ SMD2216

Model	Color temp.	LM/M	Power/M	Light efficiency	CRI (Ra)	FPC copper
ES-FS2216WW-490-24-Y	1800K	2000LM	<23W	87LM/W	90+	3OZ
ES-FS2216WW-490-24-Y	2100K	2070LM	<23W	90LM/W	90+	3OZ
ES-FS2216WW-490-24-Y	2300K	2070LM	<23W	90LM/W	90+	3OZ
ES-FS2216WW-490-24-Y	2700K	2185LM	<23W	95LM/W	90+	3OZ
ES-FS2216WW-490-24-Y	3000K	2185LM	<23W	95LM/W	90+	3OZ
ES-FS2216WW-490-24-Y	3500K	2185LM	<23W	95LM/W	90+	3OZ
ES-FS2216NW-490-24-Y	4000K	2229LM	<23W	98LM/W	90+	3OZ
ES-FS2216NW-490-24-Y	5000K	2254LM	<23W	98LM/W	90+	3OZ
ES-FS2216PW-490-24-Y	6500K	2208LM	<23W	96LM/W	90+	3OZ

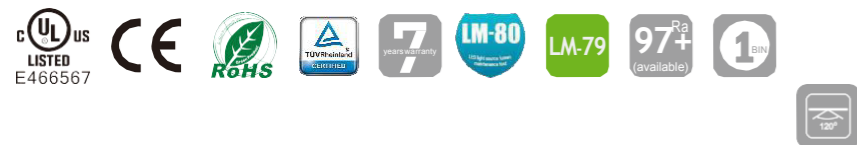
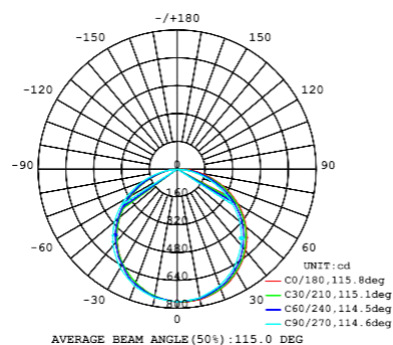

Strip length: CE:500CM UL:13.12FT

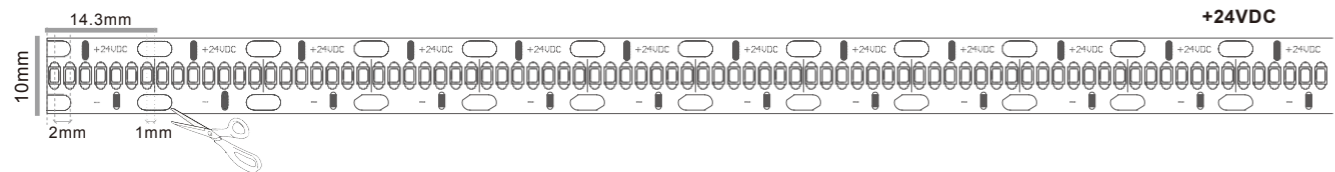

IP Rating:

- IP20---Non waterproof
- IP54---Nano coated
- IP65---Silicon coated
- IP67---Silicon coated & Wrapped heat shrink tube
- IP67---PVC extrusion
- IP67---Silicon extrusion
- IP67---Silicon tube(transparent)
- IP68---Silicon tube(transparent) & Inject silicon glue

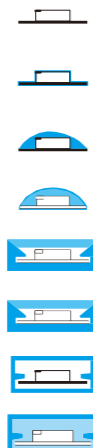

AL. profiles (mm)

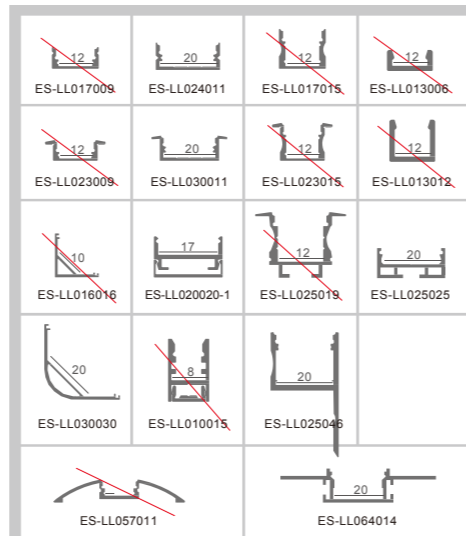

Part Number:ES-FS2216C-364-24-Y

High Density  
RA 90+ SMD2216

Model	Color temp.	LM/M	Power/M	Light efficiency	CRI (Ra)	FPC copper
ES-FS2216WW-364-24-Y	1800K	2000LM	<23W	87LM/W	90+	3OZ
ES-FS2216WW-364-24-Y	2100K	2070LM	<23W	90LM/W	90+	3OZ
ES-FS2216WW-364-24-Y	2300K	2070LM	<23W	90LM/W	90+	3OZ
ES-FS2216WW-364-24-Y	2700K	2185LM	<23W	95LM/W	90+	3OZ
ES-FS2216WW-364-24-Y	3000K	2185LM	<23W	95LM/W	90+	3OZ
ES-FS2216WW-364-24-Y	3500K	2185LM	<23W	95LM/W	90+	3OZ
ES-FS2216NW-364-24-Y	4000K	2229LM	<23W	98LM/W	90+	3OZ
ES-FS2216NW-364-24-Y	5000K	2254LM	<23W	98LM/W	90+	3OZ
ES-FS2216PW-364-24-Y	6500K	2208LM	<23W	96LM/W	90+	3OZ

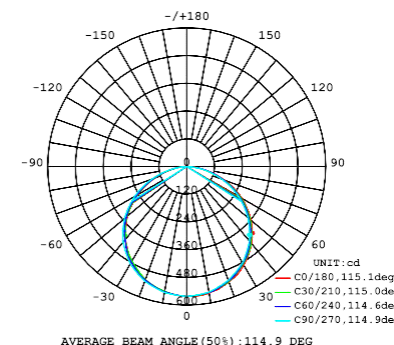

Strip length: CE:500CM UL:13.12FT

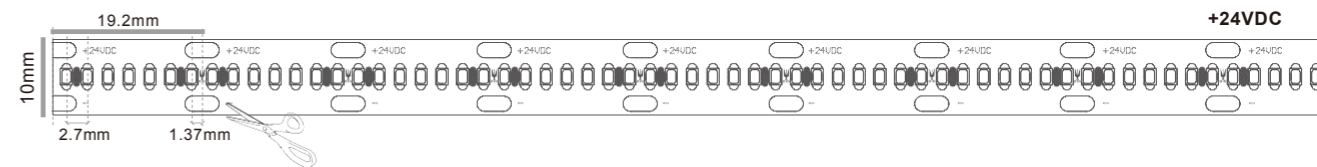

IP Rating:

- IP20---Non waterproof
- IP54---Nano coated
- IP65---Silicon coated
- IP67---Silicon coated & Wrapped heat shrink tube
- IP67---PVC extrusion
- IP67---Silicon extrusion
- IP67---Silicon tube(transparent)
- IP68---Silicon tube(transparent) & Inject silicon glue

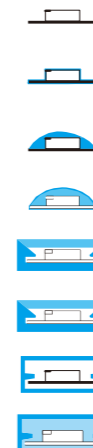

AL. profiles (mm)

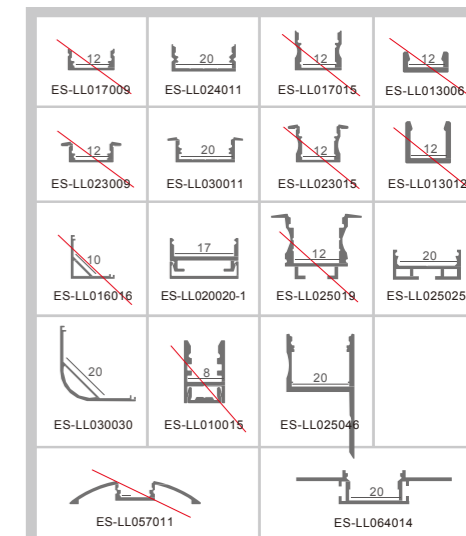



Part Number:ES-FS2216C-266-24-Y

High Density  
RA 90+ SMD2216

Model	Color temp.	LM/M	Power/M	Light efficiency	CRI (Ra)	FPC copper
ES-FS2216WW-266-24-Y	1800K	1750LM	<19.2W	91LM/W	90+	3OZ
ES-FS2216WW-266-24-Y	2100K	1800LM	<19.2W	94LM/W	90+	3OZ
ES-FS2216WW-266-24-Y	2300K	1800LM	<19.2W	94LM/W	90+	3OZ
ES-FS2216WW-266-24-Y	2700K	1850LM	<19.2W	96LM/W	90+	3OZ
ES-FS2216WW-266-24-Y	3000K	1950LM	<19.2W	102LM/W	90+	3OZ
ES-FS2216WW-266-24-Y	3500K	1950LM	<19.2W	102LM/W	90+	3OZ
ES-FS2216NW-266-24-Y	4000K	2070LM	<19.2W	108LM/W	90+	3OZ
ES-FS2216NW-266-24-Y	5000K	2070LM	<19.2W	108LM/W	90+	3OZ
ES-FS2216PW-266-24-Y	6500K	2110LM	<19.2W	110LM/W	90+	3OZ

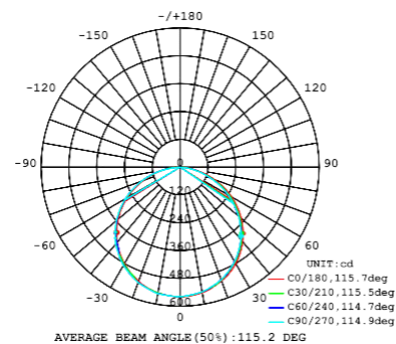

Strip length: CE:500CM UL:17FT

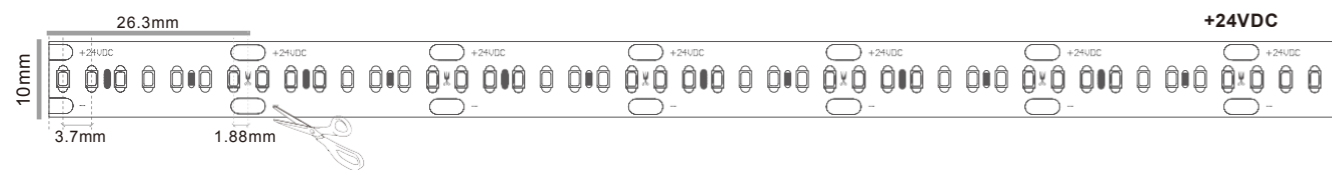

IP Rating:

- IP20---Non waterproof
- IP54---Nano coated
- IP65---Silicon coated
- IP67---Silicon coated & Wrapped heat shrink tube
- IP67---PVC extrusion
- IP67---Silicon extrusion
- IP67---Silicon tube(transparent)
- IP68---Silicon tube(transparent) & Inject silicon glue

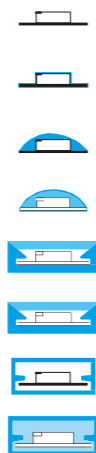

AL. profiles (mm)



Part Number:ES-FS2216C-266-24-Y

High Density  
RA 90+ SMD2216

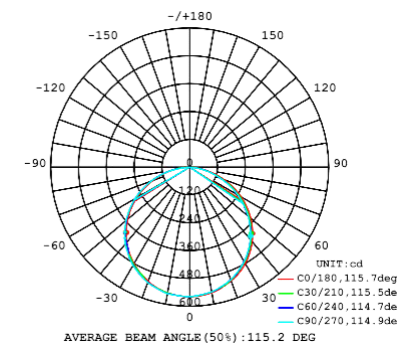
Model	Color temp.	LM/M	Power/M	Light efficiency	CRI (Ra)	FPC copper
ES-FS2216WW-266-24-Y	1800K	1312LM	<16W	82LM/W	90+	3OZ
ES-FS2216WW-266-24-Y	2100K	1312LM	<16W	82LM/W	90+	3OZ
ES-FS2216WW-266-24-Y	2300K	1312LM	<16W	82LM/W	90+	3OZ
ES-FS2216WW-266-24-Y	2700K	1376LM	<16W	86LM/W	90+	3OZ
ES-FS2216WW-266-24-Y	3000K	1376LM	<16W	86LM/W	90+	3OZ
ES-FS2216WW-266-24-Y	3500K	1440LM	<16W	90LM/W	90+	3OZ
ES-FS2216NW-266-24-Y	4000K	1440LM	<16W	90LM/W	90+	3OZ
ES-FS2216NW-266-24-Y	5000K	1472LM	<16W	92LM/W	90+	3OZ
ES-FS2216PW-266-24-Y	6500K	1472LM	<16W	92LM/W	90+	3OZ

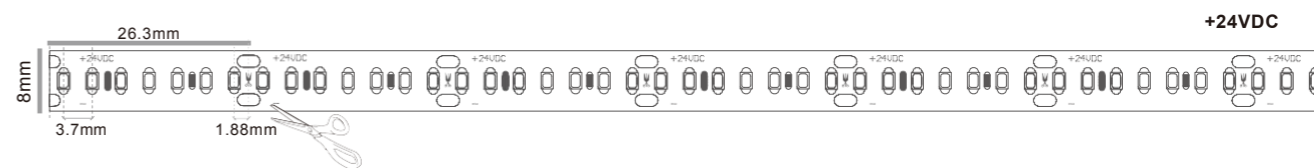

Strip length: CE:500CM UL:20.5FT



IP Rating:

- IP20---Non waterproof
- IP54---Nano coated
- IP65---Silicon coated
- IP67---Silicon coated & Wrapped heat shrink tube
- IP67---PVC extrusion
- IP67---Silicon extrusion
- IP67---Silicon tube(transparent)
- IP68---Silicon tube(transparent) & Inject silicon glue

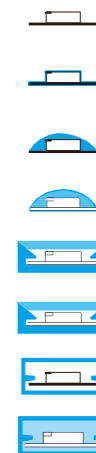

AL. profiles (mm)



Part Number:ES-FS2216C-238-24-Y

High Density  
RA 90+ SMD2216

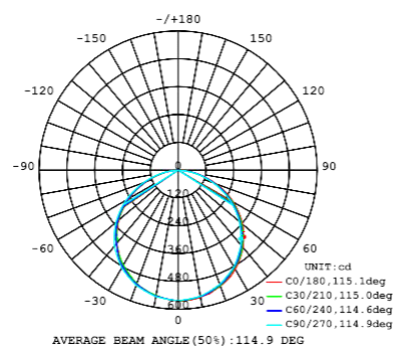
Model	Color temp.	LM/M	Power/M	Light efficiency	CRI (Ra)	FPC copper
ES-FS2216WW-238-24-Y	1800K	1500LM	<19.2W	78LM/W	90+	3OZ
ES-FS2216WW-238-24-Y	2100K	1550LM	<19.2W	81LM/W	90+	3OZ
ES-FS2216WW-238-24-Y	2300K	1550LM	<19.2W	81LM/W	90+	3OZ
ES-FS2216WW-238-24-Y	2700K	1600LM	<19.2W	83LM/W	90+	3OZ
ES-FS2216WW-238-24-Y	3000K	1650LM	<19.2W	86LM/W	90+	3OZ
ES-FS2216WW-238-24-Y	3500K	1650LM	<19.2W	86LM/W	90+	3OZ
ES-FS2216NW-238-24-Y	4000K	1700LM	<19.2W	88LM/W	90+	3OZ
ES-FS2216NW-238-24-Y	5000K	1700LM	<19.2W	88LM/W	90+	3OZ
ES-FS2216PW-238-24-Y	6500K	1750LM	<19.2W	91LM/W	90+	3OZ

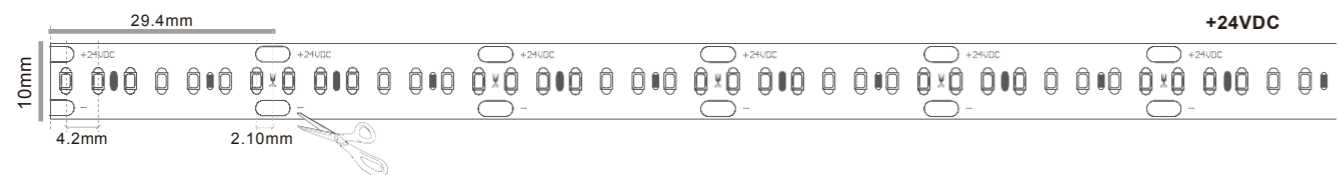

Strip length: CE:500CM UL:17FT



IP Rating:

- IP20---Non waterproof
- IP54---Nano coated
- IP65---Silicon coated
- IP67---Silicon coated & Wrapped heat shrink tube
- IP67---PVC extrusion
- IP67---Silicon extrusion
- IP67---Silicon tube(transparent)
- IP68---Silicon tube(transparent) & Inject silicon glue

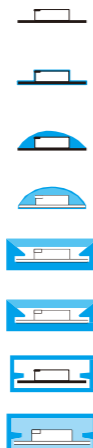

AL. profiles (mm)



Part Number:ES-FS2216C-182-24-Y

High Density  
RA 90+ SMD2216

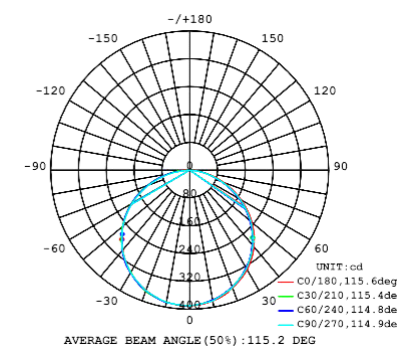
Model	Color temp.	LM/M	Power/M	Light efficiency	CRI (Ra)	FPC copper
ES-FS2216WW-182-24-Y	1800K	950LM	<12W	79LM/W	90+	3OZ
ES-FS2216WW-182-24-Y	2100K	1000LM	<12W	83LM/W	90+	3OZ
ES-FS2216WW-182-24-Y	2300K	1000LM	<12W	83LM/W	90+	3OZ
ES-FS2216WW-182-24-Y	2700K	1050LM	<12W	87LM/W	90+	3OZ
ES-FS2216WW-182-24-Y	3000K	1050LM	<12W	87LM/W	90+	3OZ
ES-FS2216WW-182-24-Y	3500K	1050LM	<12W	87LM/W	90+	3OZ
ES-FS2216NW-182-24-Y	4000K	1100LM	<12W	92LM/W	90+	3OZ
ES-FS2216NW-182-24-Y	5000K	1100LM	<12W	92LM/W	90+	3OZ
ES-FS2216PW-182-24-Y	6500K	1120LM	<12W	93LM/W	90+	3OZ

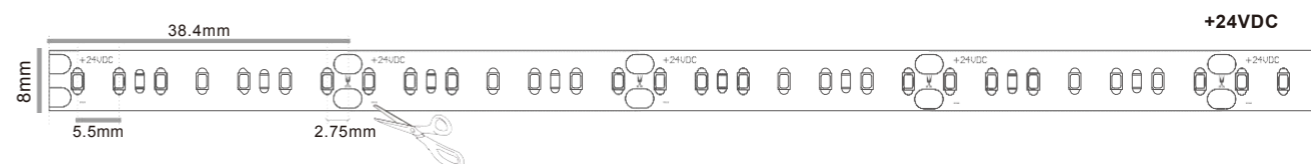

Strip length: CE:500CM UL:27.34FT



IP Rating:

- IP20---Non waterproof
- IP54---Nano coated
- IP65---Silicon coated
- IP67---Silicon coated & Wrapped heat shrink tube
- IP67---PVC extrusion
- IP67---Silicon extrusion
- IP67---Silicon tube(transparent)
- IP68---Silicon tube(transparent) & Inject silicon glue

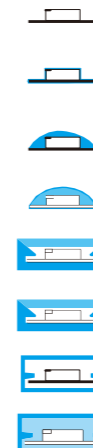

AL. profiles (mm)



Part Number:ES-FS2216C-112-24-Y

# High Density RA 90+ SMD2216

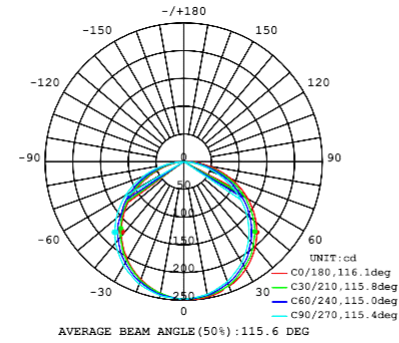
Model	Color temp.	LM/M	Power/M	Light efficiency	CRI (Ra)	FPC copper
ES-FS2216WW-112-24-Y	1800K	550LM	<7.2W	76LM/W	90+	3OZ
ES-FS2216WW-112-24-Y	2100K	590LM	<7.2W	82LM/W	90+	3OZ
ES-FS2216WW-112-24-Y	2300K	590LM	<7.2W	82LM/W	90+	3OZ
ES-FS2216WW-112-24-Y	2700K	620LM	<7.2W	86LM/W	90+	3OZ
ES-FS2216WW-112-24-Y	3000K	620LM	<7.2W	86LM/W	90+	3OZ
ES-FS2216WW-112-24-Y	3500K	620LM	<7.2W	86LM/W	90+	3OZ
ES-FS2216NW-112-24-Y	4000K	650LM	<7.2W	90LM/W	90+	3OZ
ES-FS2216NW-112-24-Y	5000K	650LM	<7.2W	90LM/W	90+	3OZ
ES-FS2216PW-112-24-Y	6500K	680LM	<7.2W	94LM/W	90+	3OZ

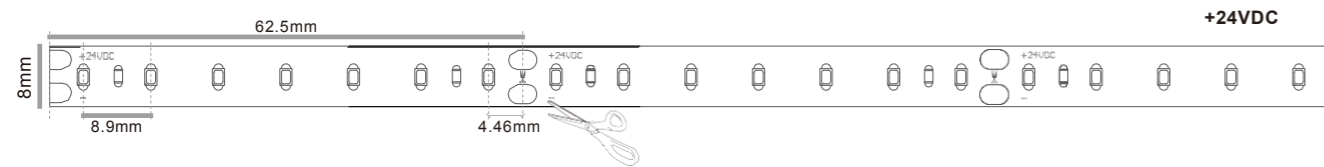

Strip length: CE:500CM UL:45.57FT



**IP Rating:**

- IP20---Non waterproof
- IP54---Nano coated
- IP65---Silicon coated
- IP67---Silicon coated & Wrapped heat shrink tube
- IP67---PVC extrusion
- IP67---Silicon extrusion
- IP67---Silicon tube(transparent)
- IP68---Silicon tube(transparent) & Inject silicon glue

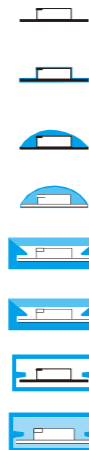

**AL. profiles (mm)**

ES-LL017009	ES-LL024011	ES-LL017015	ES-LL013006
ES-LL023009	ES-LL030011	ES-LL023015	ES-LL013012
ES-LL016016	ES-LL020020-1	ES-LL025019	ES-LL025025
ES-LL030030	ES-LL010015	ES-LL025046	
ES-LL057011	ES-LL064014		

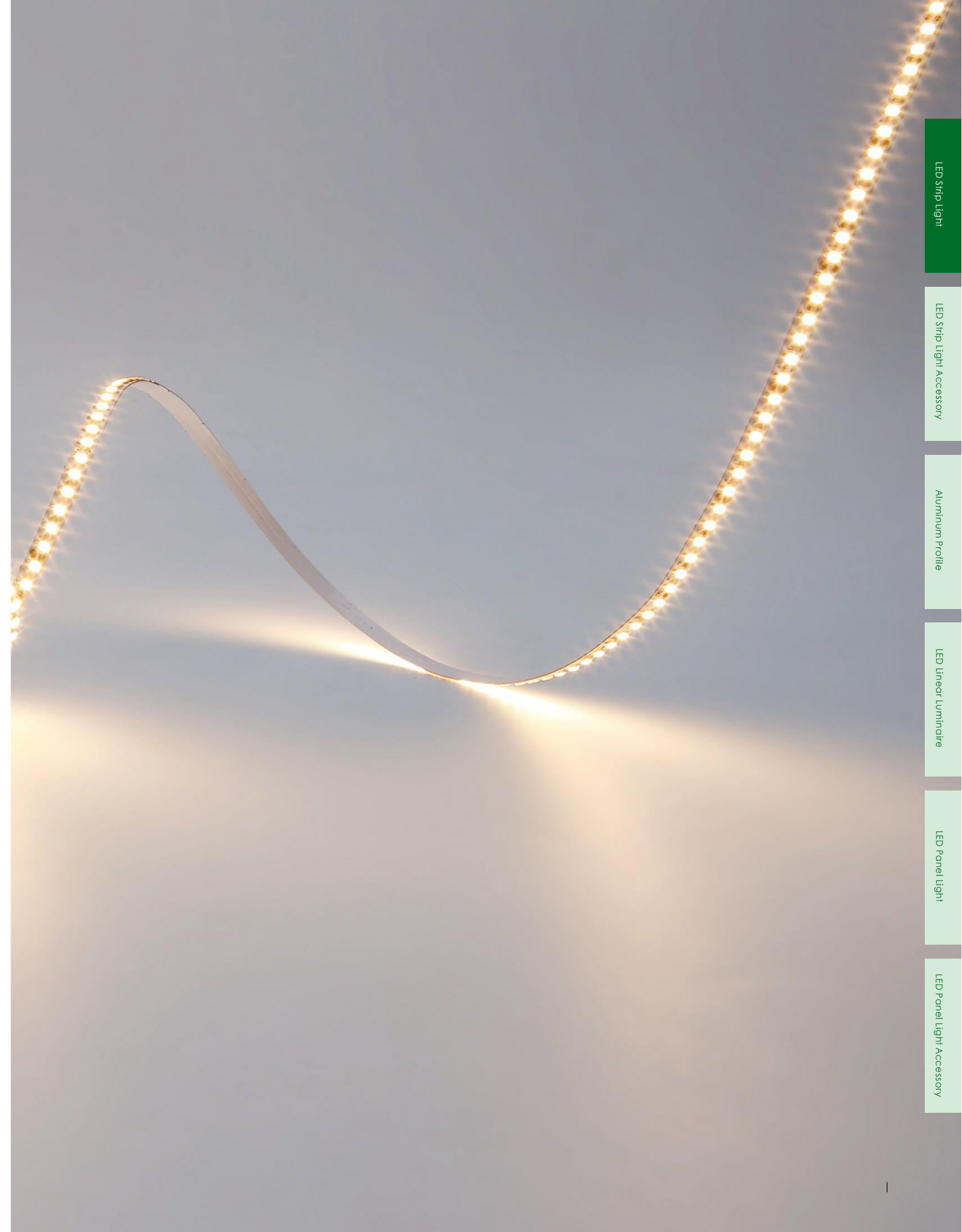

LED Strip Light

LED Strip Light Accessory

Aluminum Profile

LED Linear Luminaire

LED Panel Light

LED Panel Light Accessory

LED Strip Light

LED Strip Light Accessory

Aluminum Profile

LED Linear Luminaire

LED Panel Light

LED Panel Light Accessory

# High CRI

RA 94+ SMD2835 Series  
RA 97+ Available

## Product Features

1. RA 94+, conform to the requirement of supplementary lighting.
2. Abundant CCT for option:  
1800K|2100K|2300K|2700K|3000K|3500K|4000K|5000K|6500K.
3. 30LEDs/60LEDs/112LEDs/120LEDs/176LEDs/180LEDs/240LEDs per meter for option.
4. The way of heat dissipation better than 3528 and 5050 led source.
5. White, brown, black FPC for option, but our standard FPC color is white.

# ES-FS2835C-240H-24-Y

- ①
- ②
- ③
- ④
- ⑤

Color

Input DC Voltage  
24VDC | 12VDC

LED Type  
SMD2835

LED Qty.per meter  
240 | 180 | 176 | 120  
112 | 60 | 30

IP Index  
IP 20 | IP 54 | IP 65  
IP 67 | IP 68

1800 K	2100 K	2300 K	2700 K	3000 K
3500 K	4000 K	5000 K	6500 K	

Model	Color temp.	Chip Size (mil)	Luminous Flux@60mA		I <sub>F</sub>		CRl(Ra)
			Min.	Max.	Current	Max.	
SMD2835 	1800K	10x30	20LM	22LM	60mA	150mA	94+
	2100K	10x30	20LM	22LM	60mA	150mA	94+
	2300K	10x30	20LM	22LM	60mA	150mA	94+
	2700K	10x30	20LM	22LM	60mA	150mA	94+
	3000K	10x30	20LM	22LM	60mA	150mA	94+
	3500K	10x30	20LM	22LM	60mA	150mA	94+
	4000K	10x30	20LM	22LM	60mA	150mA	94+
	5000K	10x30	20LM	22LM	60mA	150mA	94+
	6500K	10x30	20LM	22LM	60mA	150mA	94+

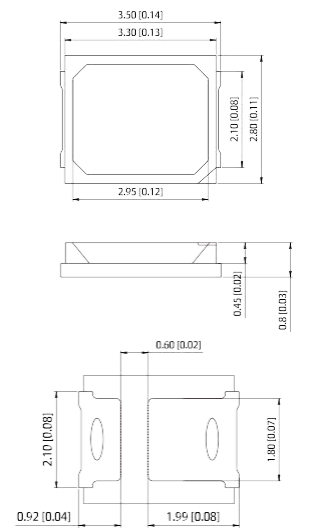

Part Number:ES-FS2835C-240H-24-Y

High CRI  
RA 94+ SMD2835

Model	Color temp.	LM/M	Power/M	Light efficiency	CRI (Ra)	FPC copper
ES-FS2835WW-240H-24-Y	1800K	2415LM	<23W	105LM/W	94+	3OZ
ES-FS2835WW-240H-24-Y	2100K	2415LM	<23W	105LM/W	94+	3OZ
ES-FS2835WW-240H-24-Y	2300K	2530LM	<23W	110LM/W	94+	3OZ
ES-FS2835WW-240H-24-Y	2700K	2645LM	<23W	115LM/W	94+	3OZ
ES-FS2835WW-240H-24-Y	3000K	2645LM	<23W	115LM/W	94+	3OZ
ES-FS2835WW-240H-24-Y	3500K	2645LM	<23W	115LM/W	94+	3OZ
ES-FS2835NW-240H-24-Y	4000K	2780LM	<23W	121LM/W	94+	3OZ
ES-FS2835NW-240H-24-Y	5000K	2780LM	<23W	121LM/W	94+	3OZ
ES-FS2835PW-240H-24-Y	6500K	2691LM	<23W	117LM/W	94+	3OZ

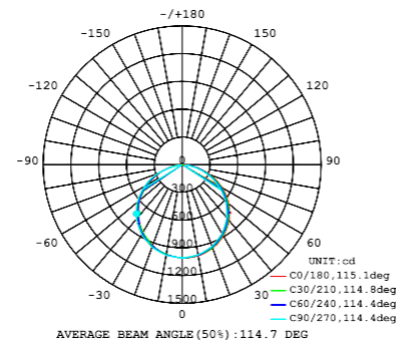

Strip length: CE:500CM UL:13.12FT

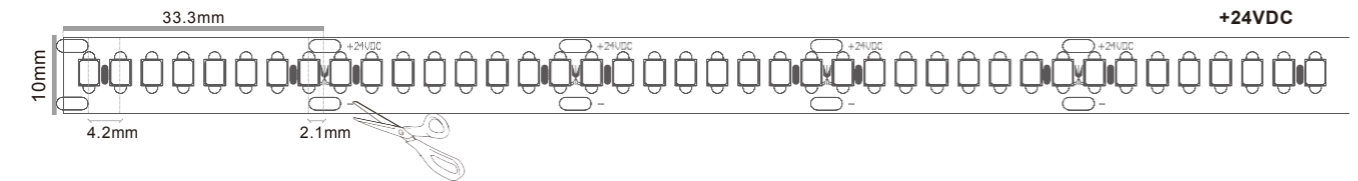

- IP Rating:
- IP20---Non waterproof
  - IP54---Nano coated
  - IP65---Silicon coated
  - IP67---Silicon coated & Wrapped heat shrink tube
  - IP67---PVC extrusion
  - IP67---Silicon extrusion
  - IP67---Silicon tube(transparent)
  - IP68---Silicon tube(transparent) & Inject silicon glue



AL. profiles (mm)



Part Number:ES-FS2835C-240-24-Y

High CRI  
RA 94+ SMD2835

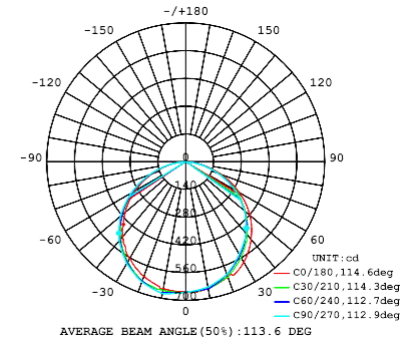
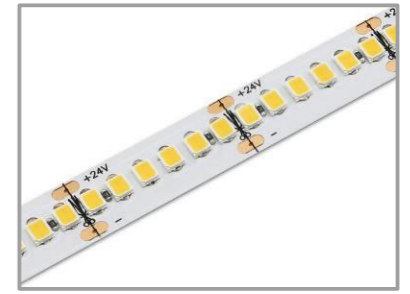
Model	Color temp.	LM/M	Power/M	CRI (Ra)	FPC copper
ES-FS2835WW-240-24-Y	1800K	1270LM	<23W	94+	3OZ
ES-FS2835WW-240-24-Y	2100K	1340LM	<23W	94+	3OZ
ES-FS2835WW-240-24-Y	2300K	1490LM	<23W	94+	3OZ
ES-FS2835WW-240-24-Y	2700K	1725LM	<23W	94+	3OZ
ES-FS2835WW-240-24-Y	3000K	1725LM	<23W	94+	3OZ
ES-FS2835WW-240-24-Y	3500K	1725LM	<23W	94+	3OZ
ES-FS2835NW-240-24-Y	4000K	1865LM	<23W	94+	3OZ
ES-FS2835NW-240-24-Y	5000K	1865LM	<23W	94+	3OZ
ES-FS2835PW-240-24-Y	6500K	1910LM	<23W	94+	3OZ

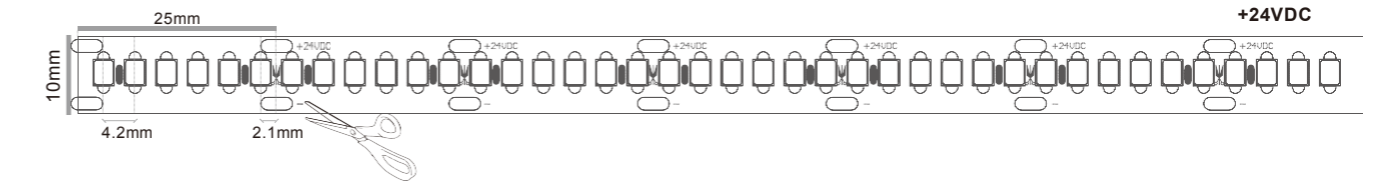

Strip length: CE:500CM UL:13.12FT



- IP Rating:
- IP20---Non waterproof
  - IP54---Nano coated
  - IP65---Silicon coated
  - IP67---Silicon coated & Wrapped heat shrink tube
  - IP67---PVC extrusion
  - IP67---Silicon extrusion
  - IP67---Silicon tube(transparent)
  - IP68---Silicon tube(transparent) & Inject silicon glue

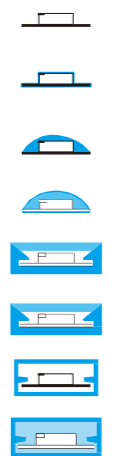

AL. profiles (mm)



Part Number:ES-FS2835C-180-24-Y

High CRI  
RA 94+ SMD2835

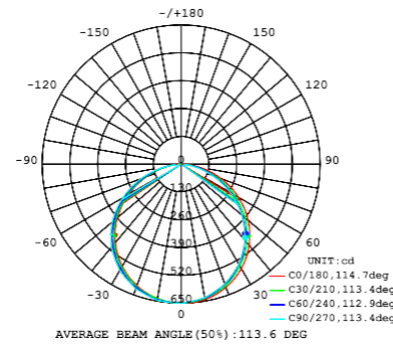
Model	Color temp.	LM/M	Power/M	CRI (Ra)	FPC copper
ES-FS2835WW-180-24-Y	1800K	1213LM	<23W	94+	3OZ
ES-FS2835WW-180-24-Y	2100K	1284LM	<23W	94+	3OZ
ES-FS2835WW-180-24-Y	2300K	1400LM	<23W	94+	3OZ
ES-FS2835WW-180-24-Y	2700K	1650LM	<23W	94+	3OZ
ES-FS2835WW-180-24-Y	3000K	1650LM	<23W	94+	3OZ
ES-FS2835WW-180-24-Y	3500K	1650LM	<23W	94+	3OZ
ES-FS2835NW-180-24-Y	4000K	1800LM	<23W	94+	3OZ
ES-FS2835NW-180-24-Y	5000K	1800LM	<23W	94+	3OZ
ES-FS2835PW-180-24-Y	6500K	1853LM	<23W	94+	3OZ

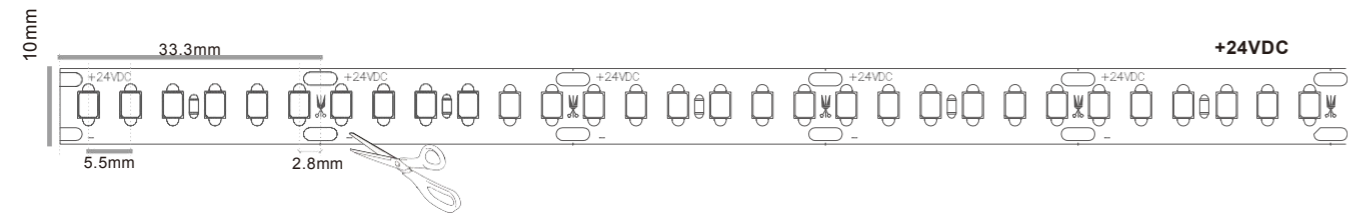

Strip length: CE:500CM UL:13.12FT



IP Rating:

- IP20---Non waterproof
- IP54---Nano coated
- IP65---Silicon coated
- IP67---Silicon coated & Wrapped heat shrink tube
- IP67---PVC extrusion
- IP67---Silicon extrusion
- IP67---Silicon tube(transparent)
- IP68---Silicon tube(transparent) & Inject silicon glue

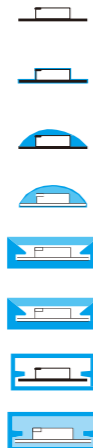

AL. profiles (mm)

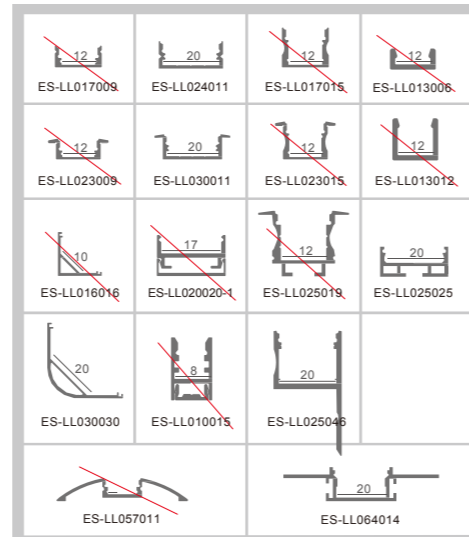

Part Number:ES-FS2835C-176-24-Y

High CRI  
RA 94+ SMD2835

Model	Color temp.	LM/M	Power/M	Light efficiency	CRI (Ra)	FPC copper
ES-FS2835WW-176-24-Y	1800K	2370LM	<23W	103LM/W	94+	3OZ
ES-FS2835WW-176-24-Y	2100K	2461LM	<23W	107LM/W	94+	3OZ
ES-FS2835WW-176-24-Y	2300K	2530LM	<23W	110LM/W	94+	3OZ
ES-FS2835WW-176-24-Y	2700K	2530LM	<23W	110LM/W	94+	3OZ
ES-FS2835WW-176-24-Y	3000K	2530LM	<23W	110LM/W	94+	3OZ
ES-FS2835WW-176-24-Y	3500K	2622LM	<23W	114LM/W	94+	3OZ
ES-FS2835NW-176-24-Y	4000K	2709LM	<23W	118LM/W	94+	3OZ
ES-FS2835NW-176-24-Y	5000K	2760LM	<23W	120LM/W	94+	3OZ
ES-FS2835PW-176-24-Y	6500K	2720LM	<23W	118LM/W	94+	3OZ

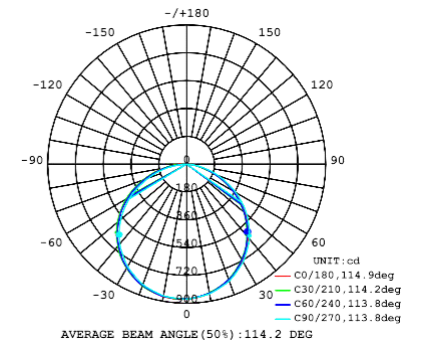

Strip length: CE:500CM UL:13.12FT

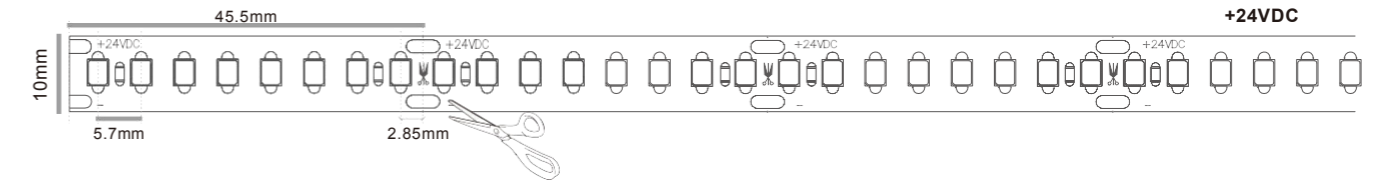

IP Rating:

- IP20---Non waterproof
- IP54---Nano coated
- IP65---Silicon coated
- IP67---Silicon coated & Wrapped heat shrink tube
- IP67---PVC extrusion
- IP67---Silicon extrusion
- IP67---Silicon tube(transparent)
- IP68---Silicon tube(transparent) & Inject silicon glue

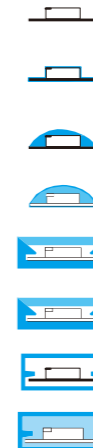

AL. profiles (mm)

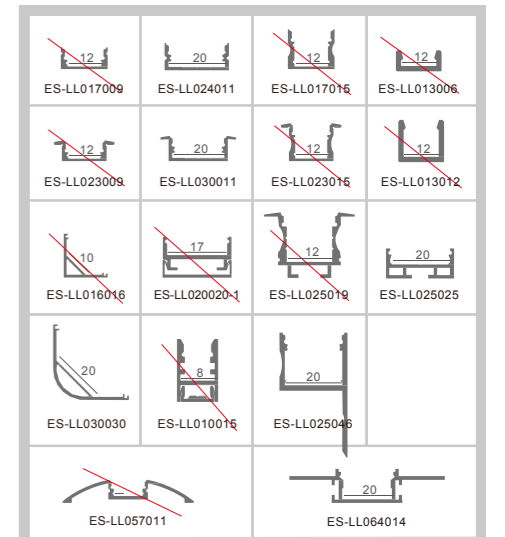

Part Number: ES-FS2835C-120-24-Y  
 Part Number: ES-FS2835C-120-12-Y

High CRI  
 RA 94+ SMD2835

Model	Color temp.	LM/M	Power/M	CRI (Ra)	FPC copper
ES-FS2835WW-120-24-Y	1800K	1190LM	<23W(24V) <18W(12V)	94+	3OZ
ES-FS2835WW-120-12-Y	2100K	1320LM	<23W(24V) <18W(12V)	94+	3OZ
ES-FS2835WW-120-24-Y	2300K	1360LM	<23W(24V) <18W(12V)	94+	3OZ
ES-FS2835WW-120-12-Y	2700K	1625LM	<23W(24V) <18W(12V)	94+	3OZ
ES-FS2835WW-120-24-Y	3000K	1625LM	<23W(24V) <18W(12V)	94+	3OZ
ES-FS2835WW-120-12-Y	3500K	1625LM	<23W(24V) <18W(12V)	94+	3OZ
ES-FS2835NW-120-24-Y	4000K	1735LM	<23W(24V) <18W(12V)	94+	3OZ
ES-FS2835NW-120-12-Y	5000K	1735LM	<23W(24V) <18W(12V)	94+	3OZ
ES-FS2835PW-120-24-Y	6500K	1825LM	<23W(24V) <18W(12V)	94+	3OZ

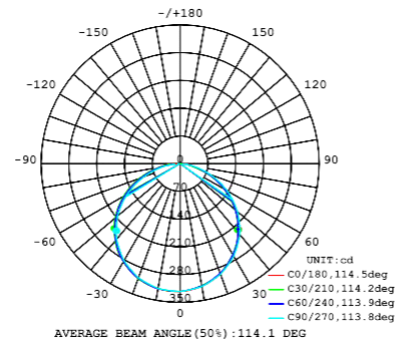
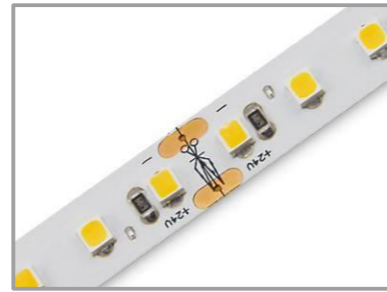

Strip length: CE:500CM UL:13.12FT(24V) | 11.4FT(12V)

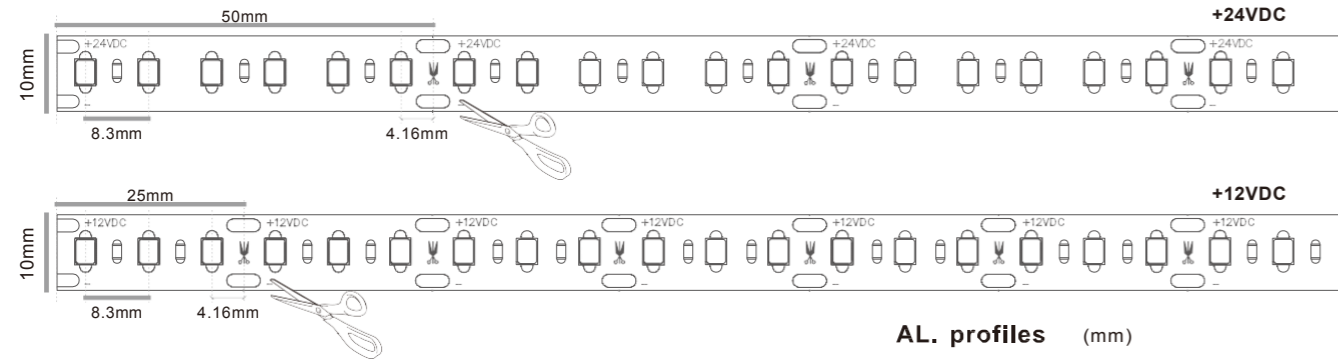

IP Rating:

- IP20---Non waterproof
- IP54---Nano coated
- IP65---Silicon coated
- IP67---Silicon coated & Wrapped heat shrink tube
- IP67---PVC extrusion
- IP67---Silicon extrusion
- IP67---Silicon tube(transparent)
- IP68---Silicon tube(transparent) & Inject silicon glue

AL. profiles (mm)

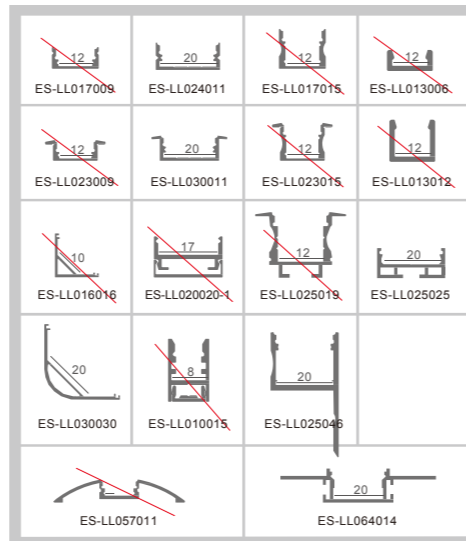

Part Number: ES-FS2835C-112-24-Y

High CRI  
 RA 94+ SMD2835

Model	Color temp.	LM/M	Power/M	Light efficiency	CRI (Ra)	FPC copper
ES-FS2835WW-112-24-Y	1800K	1680LM	<16.8W	100LM/W	94+	3OZ
ES-FS2835WW-112-24-Y	2100K	1760LM	<16.8W	105LM/W	94+	3OZ
ES-FS2835WW-112-24-Y	2300K	1760LM	<16.8W	105LM/W	94+	3OZ
ES-FS2835WW-112-24-Y	2700K	1810LM	<16.8W	108LM/W	94+	3OZ
ES-FS2835WW-112-24-Y	3000K	1848LM	<16.8W	110LM/W	94+	3OZ
ES-FS2835WW-112-24-Y	3500K	1848LM	<16.8W	110LM/W	94+	3OZ
ES-FS2835NW-112-24-Y	4000K	1900LM	<16.8W	116LM/W	94+	3OZ
ES-FS2835NW-112-24-Y	5000K	1900LM	<16.8W	116LM/W	94+	3OZ
ES-FS2835PW-112-24-Y	6500K	1860LM	<16.8W	111LM/W	94+	3OZ

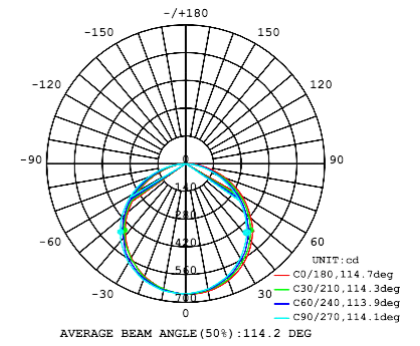

Strip length: CE:500CM UL:16.4FT

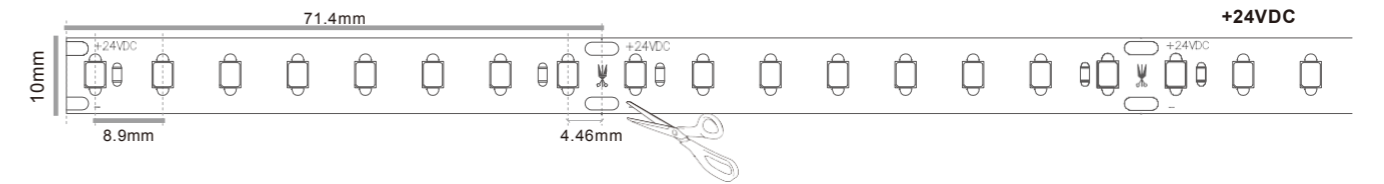

IP Rating:

- IP20---Non waterproof
- IP54---Nano coated
- IP65---Silicon coated
- IP67---Silicon coated & Wrapped heat shrink tube
- IP67---PVC extrusion
- IP67---Silicon extrusion
- IP67---Silicon tube(transparent)
- IP68---Silicon tube(transparent) & Inject silicon glue

AL. profiles (mm)

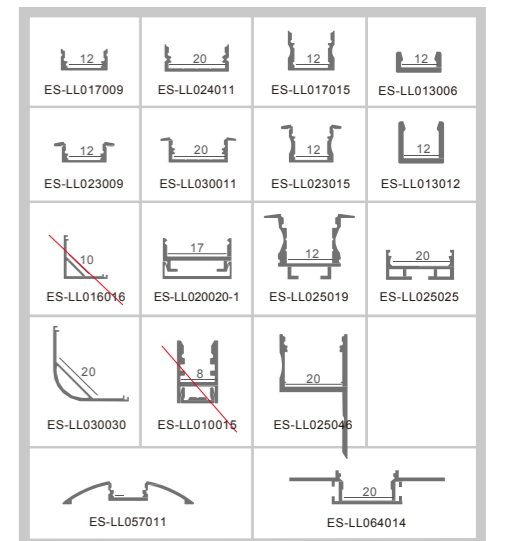

LED Strip Light

LED Strip Light Accessory

Aluminum Profile

LED Linear Luminaire

LED Panel Light

LED Panel Light Accessory

LED Strip Light

LED Strip Light Accessory

Aluminum Profile

LED Linear Luminaire

LED Panel Light

LED Panel Light Accessory

Part Number:ES-FS2835C-60-24-Y  
Part Number:ES-FS2835C-60-12-Y

High CRI  
RA 94+ SMD2835

Model	Color temp.	LM/M	Power/M	CRI (Ra)	FPC copper
ES-FS2835WW-60-24-Y	1800K	720LM	<14.4W	94+	3OZ
ES-FS2835WW-60-24-Y	2100K	770LM	<14.4W	94+	3OZ
ES-FS2835WW-60-24-Y	2300K	850LM	<14.4W	94+	3OZ
ES-FS2835WW-60-24-Y	2700K	990LM	<14.4W	94+	3OZ
ES-FS2835WW-60-24-Y	3000K	990LM	<14.4W	94+	3OZ
ES-FS2835WW-60-24-Y	3500K	990LM	<14.4W	94+	3OZ
ES-FS2835NW-60-24-Y	4000K	1050LM	<14.4W	94+	3OZ
ES-FS2835NW-60-24-Y	5000K	1050LM	<14.4W	94+	3OZ
ES-FS2835PW-60-24-Y	6500K	1100LM	<14.4W	94+	3OZ

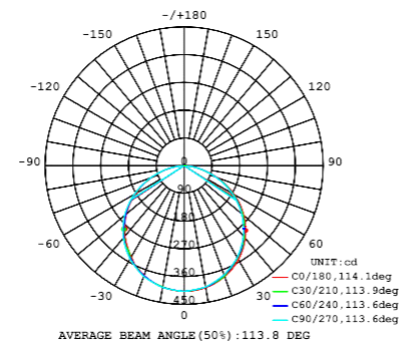

Strip length: CE:500CM UL:21.33FT(24V) | 13.12FT(12V)

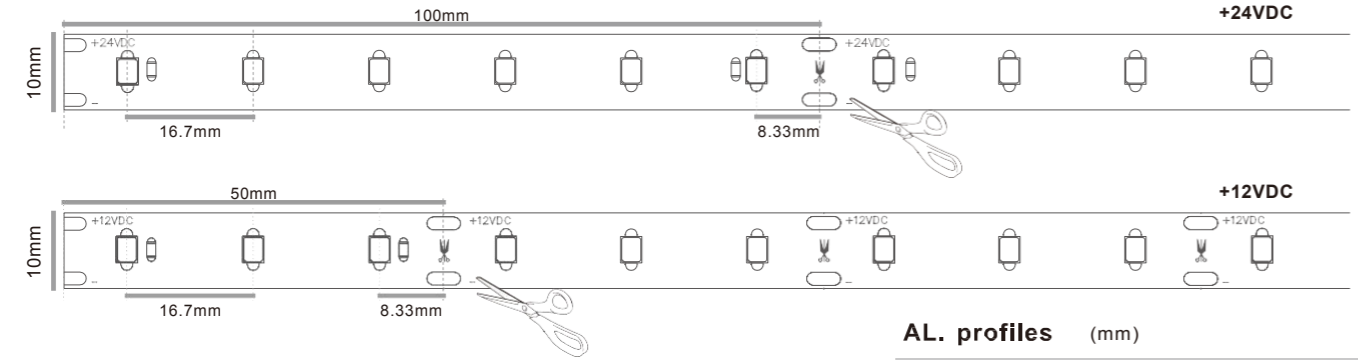

- IP Rating:
- IP20---Non waterproof
  - IP54---Nano coated
  - IP65---Silicon coated
  - IP67---Silicon coated & Wrapped heat shrink tube
  - IP67---PVC extrusion
  - IP67---Silicon extrusion
  - IP67---Silicon tube(transparent)
  - IP68---Silicon tube(transparent) & Inject silicon glue

AL. profiles (mm)

ES-LL017009	ES-LL024011	ES-LL017015	ES-LL013006
ES-LL023009	ES-LL030011	ES-LL023015	ES-LL013012
ES-LL016016	ES-LL020020-1	ES-LL025019	ES-LL025025
ES-LL030030	ES-LL010015	ES-LL025046	
ES-LL057011	ES-LL064014		

Part Number:ES-FS2835C-30-12-Y  
Part Number:ES-FS2835C-30-24-Y

High CRI  
RA 94+ SMD2835

Model	Color temp.	LM/M	Power/M	CRI (Ra)	FPC copper
ES-FS2835WW-30-12-Y	1800K	370LM	<7.2W	94+	3OZ
ES-FS2835WW-30-12-Y	2100K	400LM	<7.2W	94+	3OZ
ES-FS2835WW-30-12-Y	2300K	445LM	<7.2W	94+	3OZ
ES-FS2835WW-30-12-Y	2700K	500LM	<7.2W	94+	3OZ
ES-FS2835WW-30-12-Y	3000K	500LM	<7.2W	94+	3OZ
ES-FS2835WW-30-12-Y	3500K	500LM	<7.2W	94+	3OZ
ES-FS2835NW-30-12-Y	4000K	540LM	<7.2W	94+	3OZ
ES-FS2835NW-30-12-Y	5000K	540LM	<7.2W	94+	3OZ
ES-FS2835PW-30-12-Y	6500K	570LM	<7.2W	94+	3OZ

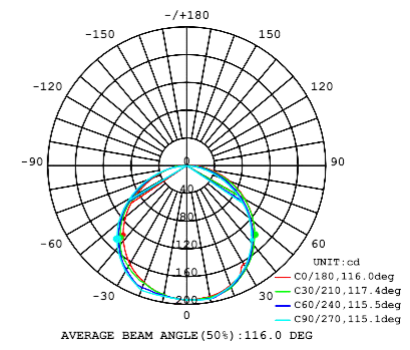

Strip length: CE:500CM UL:26.25FT(12V) | 47.57FT(24V)

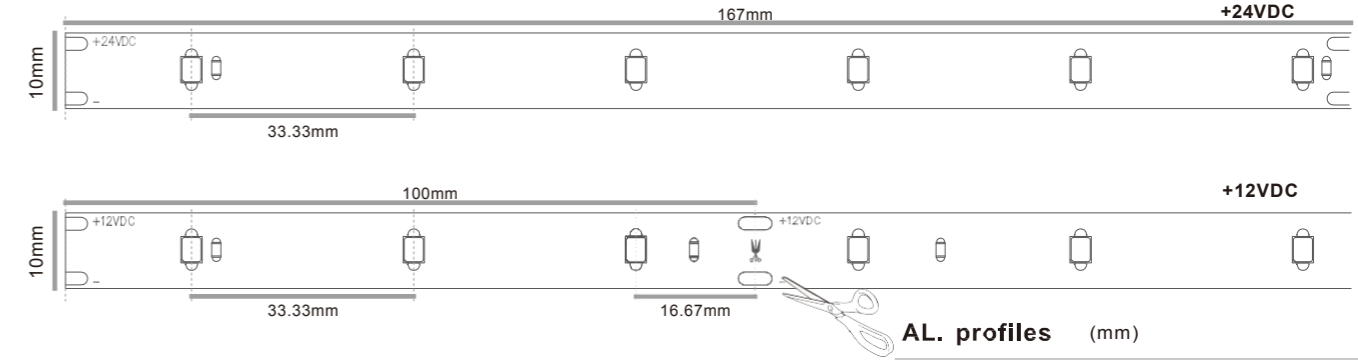

- IP Rating:
- IP20---Non waterproof
  - IP54---Nano coated
  - IP65---Silicon coated
  - IP67---Silicon coated & Wrapped heat shrink tube
  - IP67---PVC extrusion
  - IP67---Silicon extrusion
  - IP67---Silicon tube(transparent)
  - IP68---Silicon tube(transparent) & Inject silicon glue

AL. profiles (mm)

ES-LL017009	ES-LL024011	ES-LL017015	ES-LL013006
ES-LL023009	ES-LL030011	ES-LL023015	ES-LL013012
ES-LL016016	ES-LL020020-1	ES-LL025019	ES-LL025025
ES-LL030030	ES-LL010015	ES-LL025046	
ES-LL057011	ES-LL064014		



# Connector

Suitable for SMD3528/2835/2216 series one meter below 120LED, SMD5050/5630 series one meter below 60LED.  
Max.Current: 4A



Connector

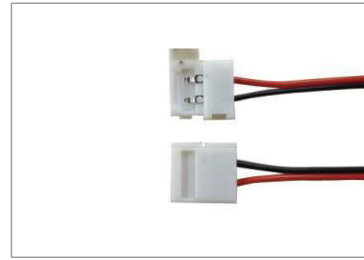

Connector with cable

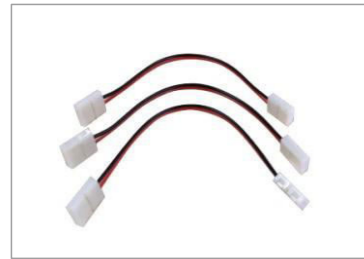

Jumper connector

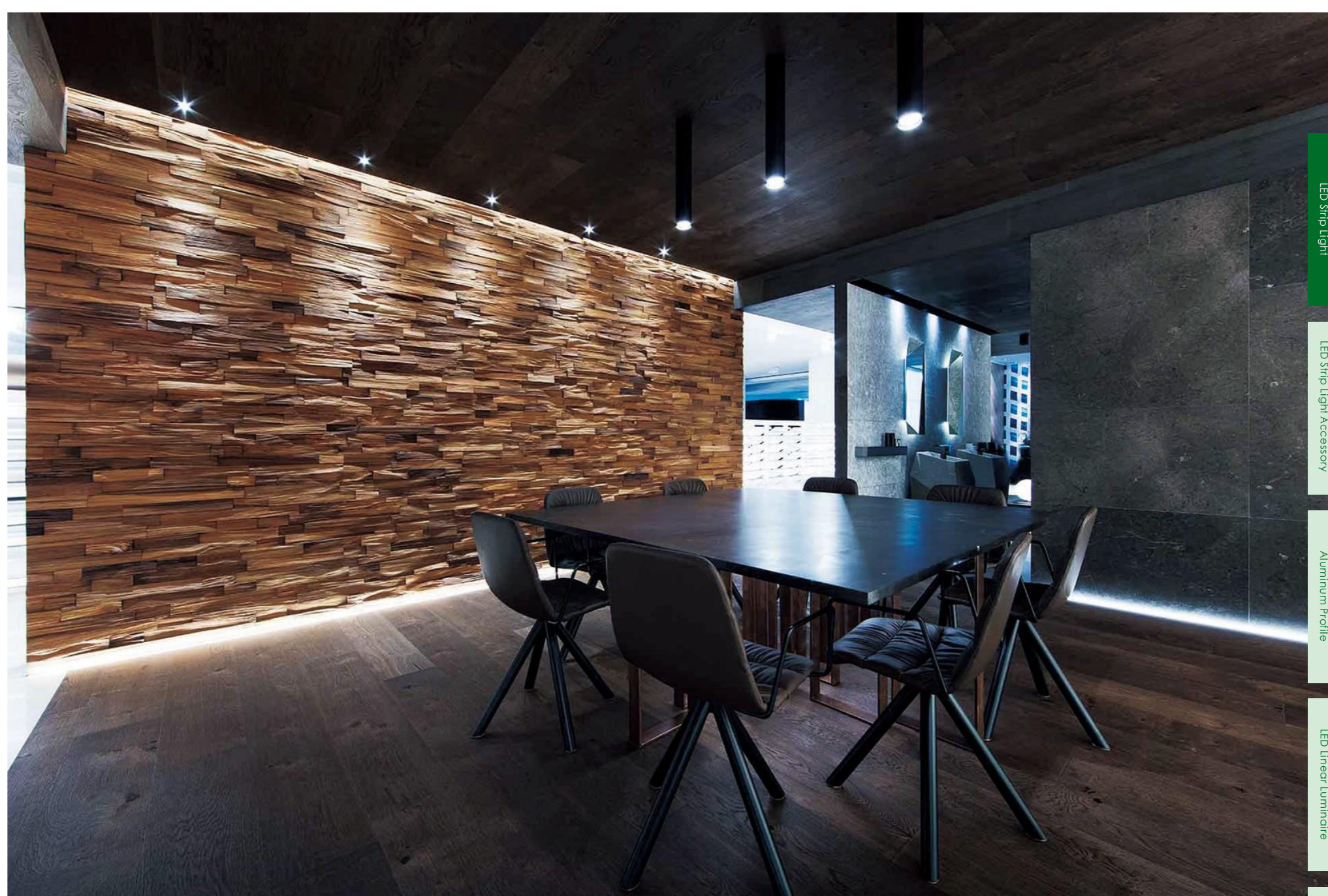

# Operational Instruction of Connectors

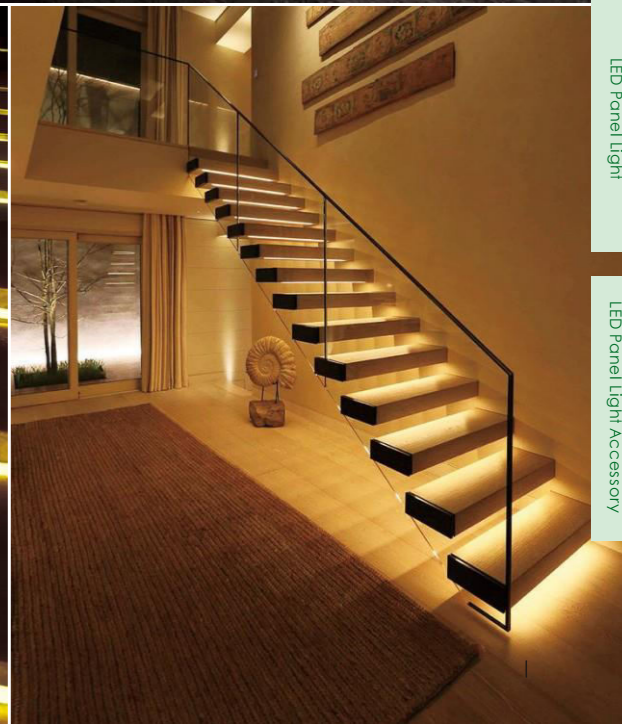
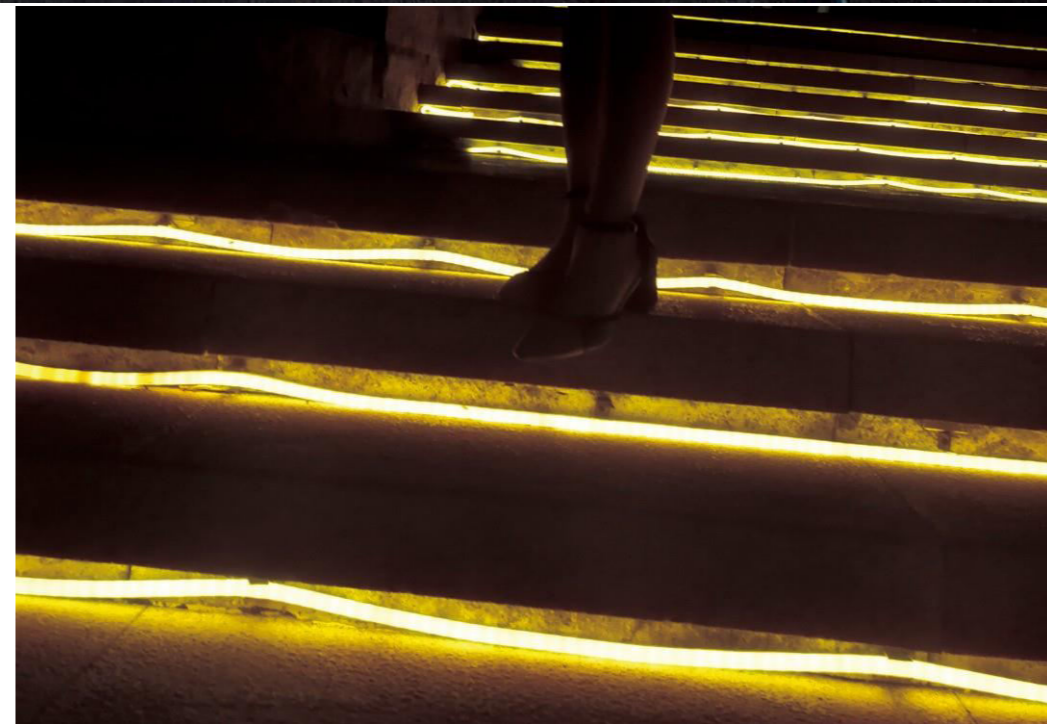
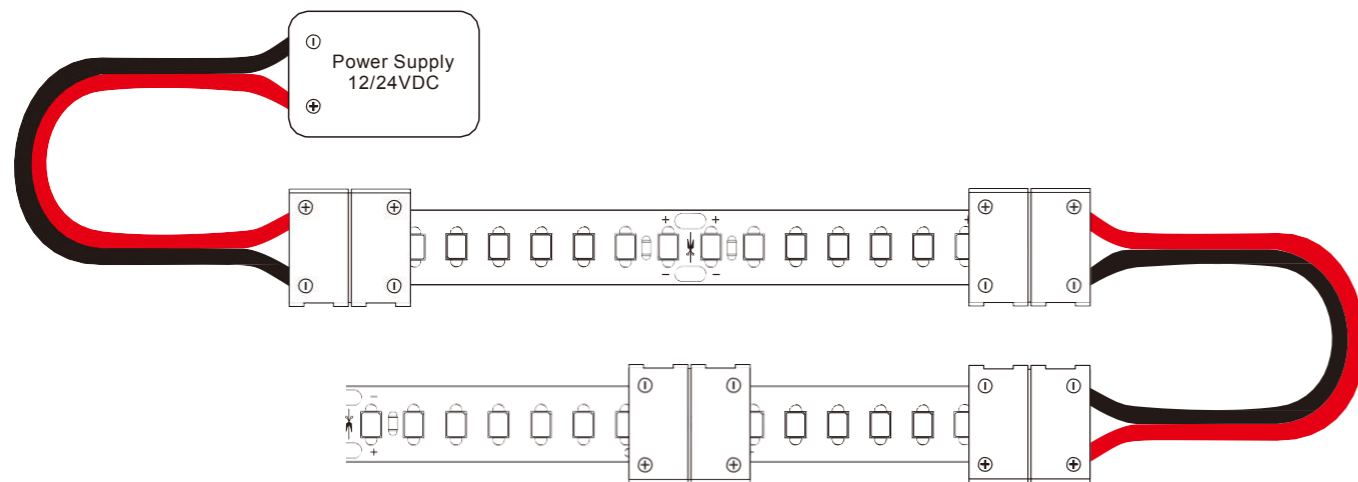

# ES-FS5630C-224-24-Y

① ② ③ ④ ⑤

## High Light Efficiency

RA 80+ SMD5630 Series  
RA 90+ Available

### Product Features

1. Low-voltage 24VDC and 12VDC, high light efficiency.
2. Energy-saving, eco-friendly, anti-UV and no optical radiation.
3. SMD 5630, 1 chip inside
4. CRI: RA 80+ (RA 90+ is available).
5. White, brown, black FPC for option, but our standard FPC color is white

Model	Color temp.	Chip Size (mil)	Luminous Flux@65mA		I <sub>F</sub>		CRI(Ra)
			Min.	Max.	Current	Max.	
SMD5630	2700K	22x35	33LM	37LM	65mA	150mA	80+
	3000K	22x35	33LM	37LM	65mA	150mA	80+
	4000K	22x35	33LM	37LM	65mA	150mA	80+
	5000K	22x35	33LM	37LM	65mA	150mA	80+
	6500K	22x35	33LM	37LM	65mA	150mA	80+

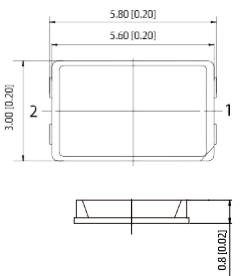

**LED Type**  
SMD5630

2700 K 3000 K 4000 K 5000 K 6500 K

**Color**

1

**LED Qty. per meter**  
240 | 224 | 112 | 64 | 60

2

**Input DC Voltage**  
24VDC | 12VDC

3

4

**IP Index**  
IP 20 | IP54 | IP65  
IP67 | IP68

5

Part Number:ES-FS5630C-240-24-Y

High Light Efficiency  
RA 80+ SMD5630

Model	Color temp.	LM/M	Power/M	Light efficiency	CRI (Ra)	FPC copper
ES-FS5630WW-240-24-Y	2700K	2250LM	<23W	97LM/W	80+	3OZ
ES-FS5630WW-240-24-Y	3000K	2250LM	<23W	97LM/W	80+	3OZ
ES-FS5630NW-240-24-Y	4000K	2300LM	<23W	100LM/W	80+	3OZ
ES-FS5630NW-240-24-Y	5000K	2350LM	<23W	102LM/W	80+	3OZ
ES-FS5630PW-240-24-Y	6500K	2415LM	<23W	105LM/W	80+	3OZ

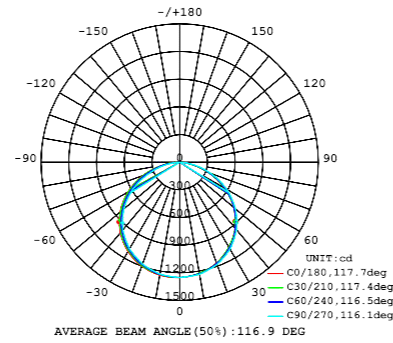
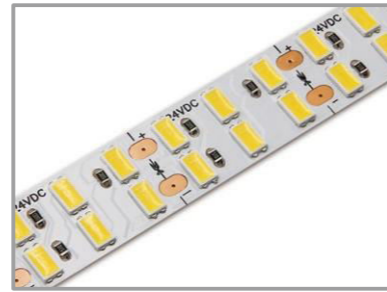

Strip length: CE:500CM UL:13.12FT

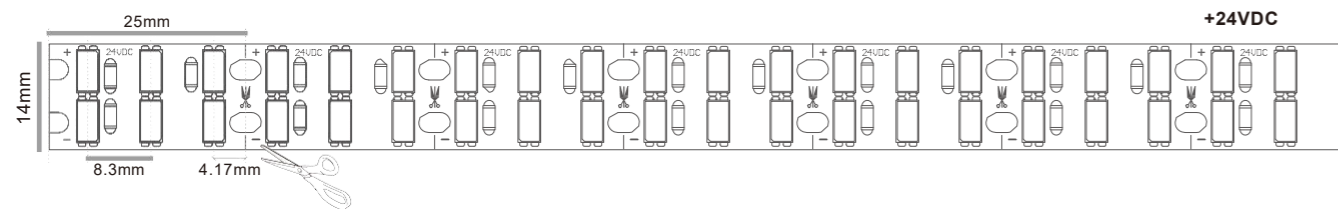

IP Rating:

- IP20---Non waterproof
- IP54---Nano coated
- IP65---Silicon coated
- IP67---Silicon coated & Wrapped heat shrink tube
- IP67---PVC extrusion
- IP67---Silicon extrusion
- IP67---Silicon tube(transparent)
- IP68---Silicon tube(transparent) & Inject silicon glue

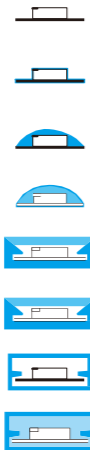

AL. profiles (mm)

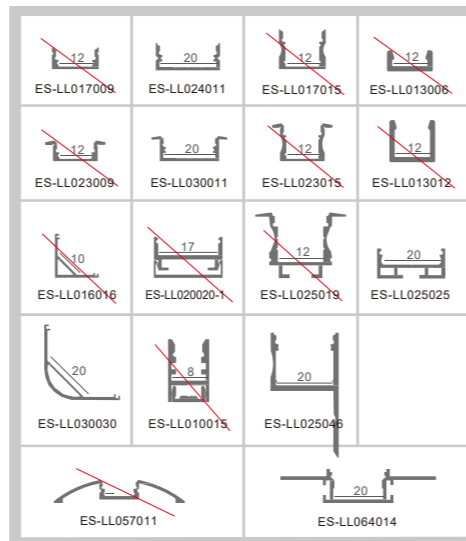

Part Number:ES-FS5630C-224-24-Y

High Light Efficiency  
RA 80+ SMD5630

Model	Color temp.	LM/M	Power/M	Light efficiency	CRI (Ra)	FPC copper
ES-FS5630WW-224-24-Y	2700K	3565LM	<23W	155LM/W	80+	3OZ
ES-FS5630WW-224-24-Y	3000K	3680LM	<23W	160LM/W	80+	3OZ
ES-FS5630NW-224-24-Y	4000K	3841LM	<23W	167LM/W	80+	3OZ
ES-FS5630NW-224-24-Y	5000K	3864LM	<23W	168LM/W	80+	3OZ
ES-FS5630PW-224-24-Y	6500K	3795LM	<23W	165LM/W	80+	3OZ

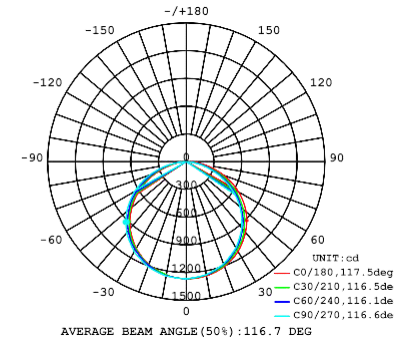
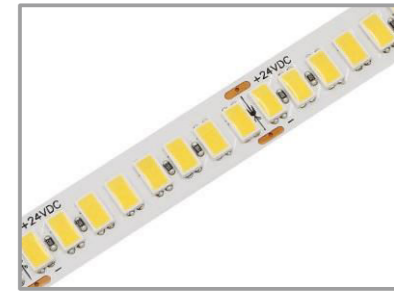

Strip length: CE:500CM UL:13.12FT

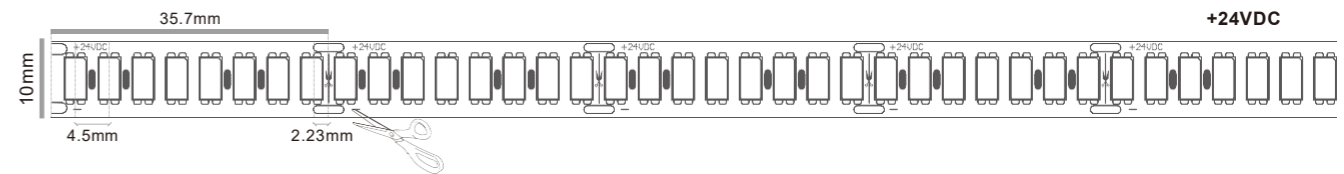

IP Rating:

- IP20---Non waterproof
- IP54---Nano coated
- IP65---Silicon coated
- IP67---Silicon coated & Wrapped heat shrink tube
- IP67---PVC extrusion
- IP67---Silicon extrusion
- IP67---Silicon tube(transparent)
- IP68---Silicon tube(transparent) & Inject silicon glue

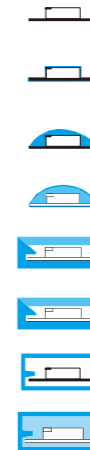

AL. profiles (mm)

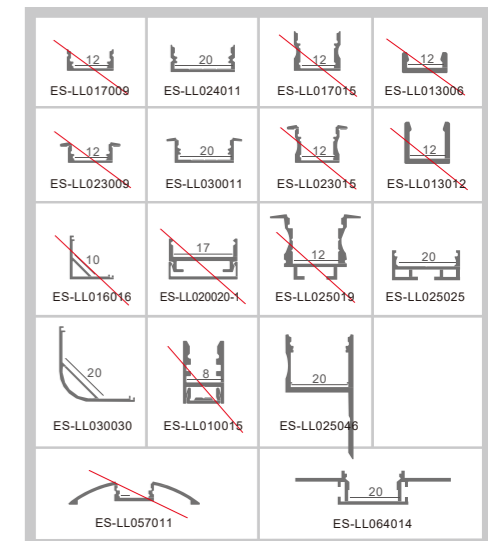

LED Strip Light

LED Strip Light Accessory

Aluminum Profile

LED Linear Luminaire

LED Panel Light

LED Panel Light Accessory

LED Strip Light

LED Strip Light Accessory

Aluminum Profile

LED Linear Luminaire

LED Panel Light

LED Panel Light Accessory

Part Number:ES-FS5630C-112-24-Y

High Light Efficiency  
RA 80+ SMD5630

Model	Color temp.	LM/M	Power/M	Light efficiency	CRI (Ra)	FPC copper
ES-FS5630WW-112-24-Y	2700K	2805LM	<19.2W	146LM/W	80+	3OZ
ES-FS5630WW-112-24-Y	3000K	2805LM	<19.2W	146LM/W	80+	3OZ
ES-FS5630NW-112-24-Y	4000K	2940LM	<19.2W	153LM/W	80+	3OZ
ES-FS5630NW-112-24-Y	5000K	2940LM	<19.2W	153LM/W	80+	3OZ
ES-FS5630PW-112-24-Y	6500K	2840LM	<19.2W	148LM/W	80+	3OZ

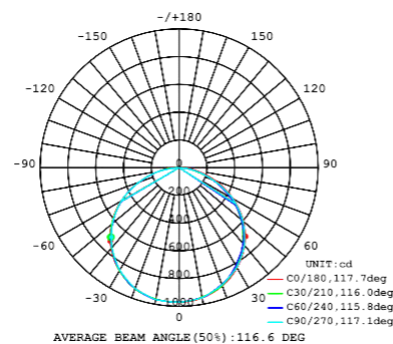

Strip length: CE:500CM UL:13.12FT

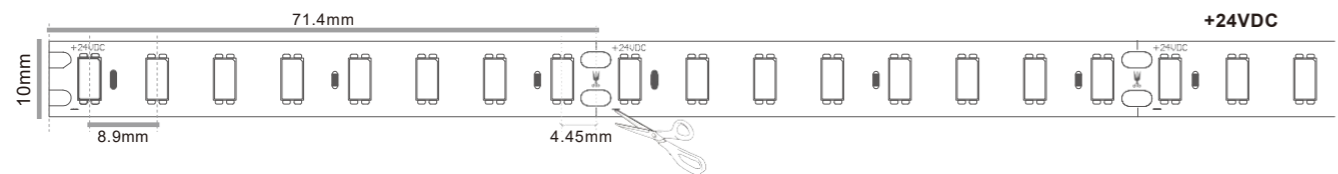

IP Rating:

- IP20---Non waterproof
- IP54---Nano coated
- IP65---Silicon coated
- IP67---Silicon coated & Wrapped heat shrink tube
- IP67---PVC extrusion
- IP67---Silicon extrusion
- IP67---Silicon tube(transparent)
- IP68---Silicon tube(transparent) & Inject silicon glue

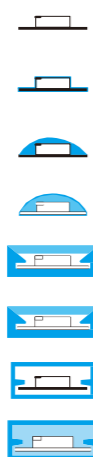

AL. profiles (mm)

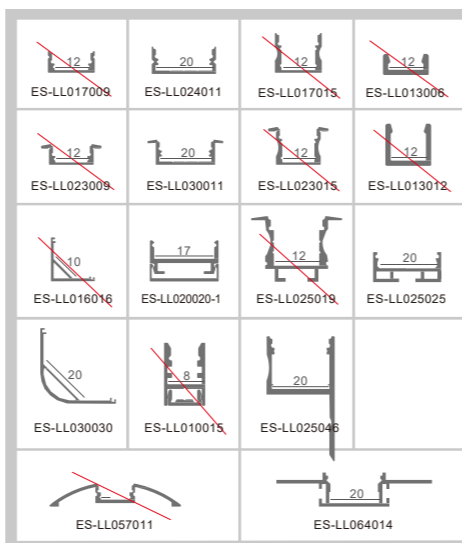

Part Number:ES-FS5630C-64-24-Y

High Light Efficiency  
RA 80+ SMD5630

Model	Color temp.	LM/M	Power/M	CRI (Ra)	Light efficiency	FPC copper	IP Rating
ES-FS5630WW-64-24-Y	2700K	1400LM	<10W	80+	140LM/W	3OZ	IP20 IP65 IP54 IP67 IP68
ES-FS5630WW-64-24-Y	3000K	1450LM	<10W	80+	145LM/W	3OZ	
ES-FS5630NW-64-24-Y	4000K	1500LM	<10W	80+	150LM/W	3OZ	
ES-FS5630NW-64-24-Y	5000K	1550LM	<10W	80+	155LM/W	3OZ	
ES-FS5630PW-64-24-Y	6500K	1550LM	<10W	80+	155LM/W	3OZ	

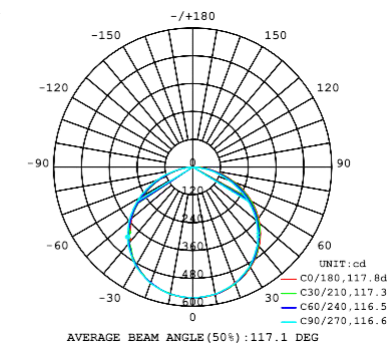

Model	Color temp.	LM/M	Power/M	CRI (Ra)	Light efficiency	FPC copper	IP Rating
ES-FS5630WW-64-24-Y	2700K	1900LM	<19.2W	80+	99LM/W	3OZ	IP20 IP65 IP54
ES-FS5630WW-64-24-Y	3000K	2000LM	<19.2W	80+	104LM/W	3OZ	
ES-FS5630NW-64-24-Y	4000K	2100LM	<19.2W	80+	109LM/W	3OZ	
ES-FS5630NW-64-24-Y	5000K	2200LM	<19.2W	80+	114LM/W	3OZ	
ES-FS5630PW-64-24-Y	6500K	2200LM	<19.2W	80+	114LM/W	3OZ	



Strip length: CE:500CM UL:14.26FT(19.2W) UL:32.81FT(10W)

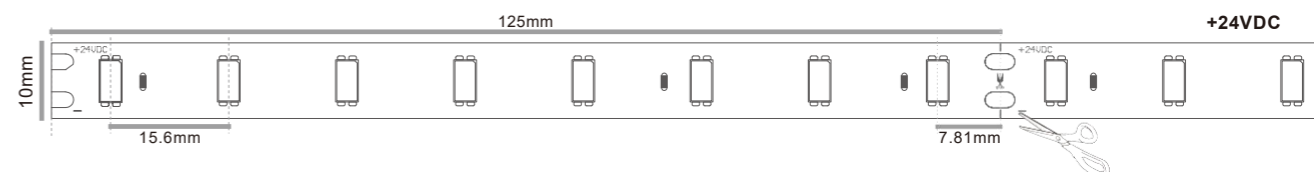

IP Rating:

- IP20---Non waterproof
- IP54---Nano coated
- IP65---Silicon coated
- IP67---Silicon coated & Wrapped heat shrink tube
- IP67---PVC extrusion
- IP67---Silicon extrusion
- IP67---Silicon tube(transparent)
- IP68---Silicon tube(transparent) & Inject silicon glue

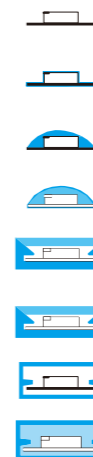

AL. profiles (mm)

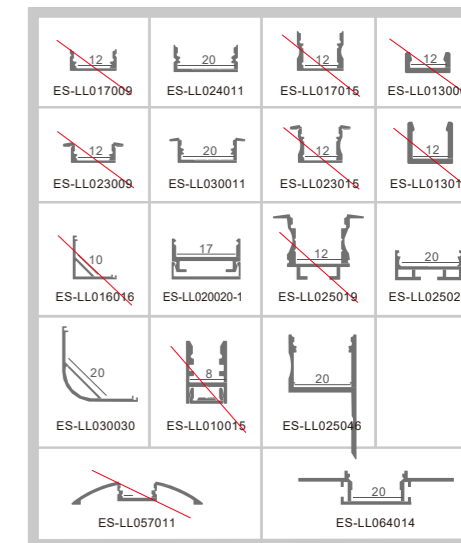

LED Strip Light

LED Strip Light Accessory

Aluminum Profile

LED Linear Luminaire

LED Panel Light

LED Panel Light Accessory

LED Strip Light

LED Strip Light Accessory

Aluminum Profile

LED Linear Luminaire

LED Panel Light

LED Panel Light Accessory

## High Light Efficiency RA 80+ SMD5630

Part Number:ES-FS5630C-60-24-Y  
Part Number:ES-FS5630C-60-12-Y

Model	Color temp.	LM/M	Power/M	Light efficiency	CRI (Ra)	FPC copper
ES-FS5630WW-60-24-Y	2700K	2645LM	<23W	115LM/W	80+	3OZ
ES-FS5630WW-60-12-Y		2106LM	<18W	117LM/W		
ES-FS5630WW-60-24-Y	3000K	2714LM	<23W	118LM/W	80+	3OZ
ES-FS5630WW-60-12-Y		2196LM	<18W	122LM/W		
ES-FS5630NW-60-24-Y	4000K	2806LM	<23W	122LM/W	80+	3OZ
ES-FS5630NW-60-12-Y		2304LM	<18W	128LM/W		
ES-FS5630NW-60-24-Y	5000K	2806LM	<23W	122LM/W	80+	3OZ
ES-FS5630NW-60-12-Y		2304LM	<18W	128LM/W		
ES-FS5630PW-60-24-Y	6500K	2875LM	<23W	125LM/W	80+	3OZ
ES-FS5630PW-60-12-Y		2340LM	<18W	130LM/W		

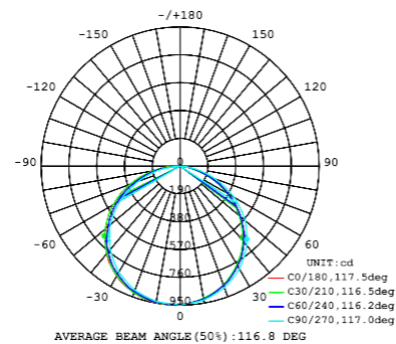

Strip length: CE:500CM UL:22.64FT(24V) | 11.32FT(12V)

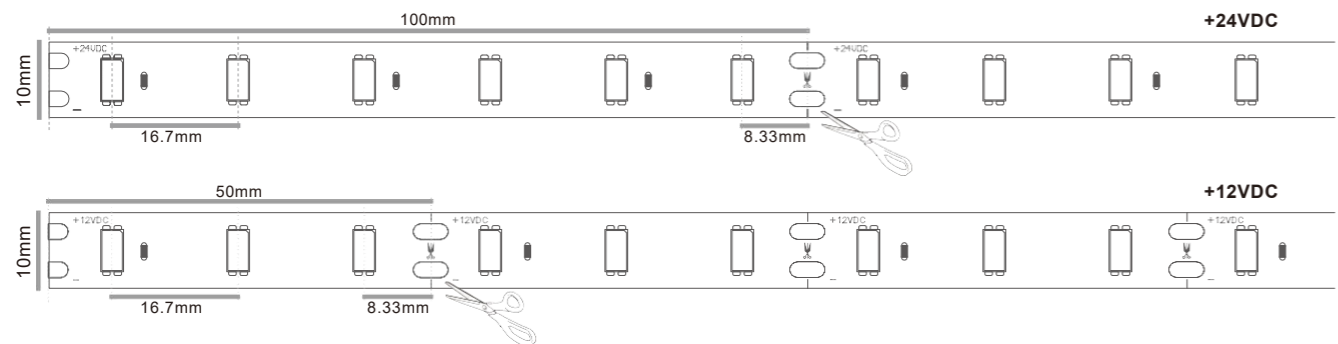

### IP Rating:

- IP20---Non waterproof
- IP54---Nano coated
- IP65---Silicon coated
- IP67---Silicon coated & Wrapped heat shrink tube
- IP67---PVC extrusion
- IP67---Silicon extrusion
- IP67---Silicon tube(transparent)
- IP68---Silicon tube(transparent) & Inject silicon glue

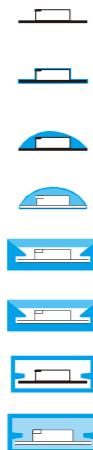

### AL. profiles (mm)

ES-LL017009	ES-LL024011	ES-LL017015	ES-LL013006
ES-LL023009	ES-LL030011	ES-LL023015	ES-LL013012
ES-LL016016	ES-LL020020	ES-LL025019	ES-LL025025
ES-LL030030	ES-LL010015	ES-LL025046	
ES-LL057011	ES-LL064014		

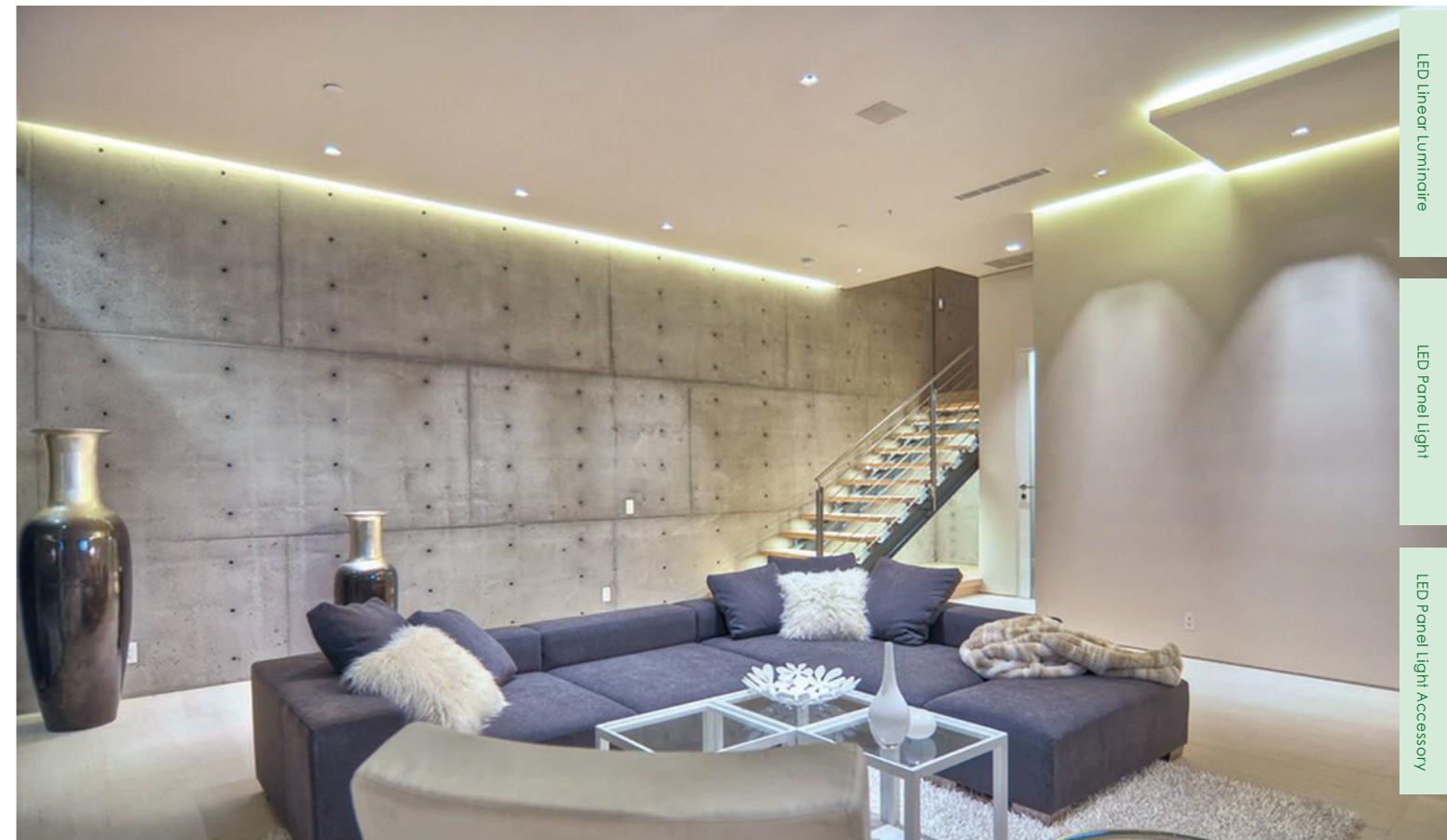

# ES-FS3528C-240-24-Y

① ② ③ ④ ⑤

## Economy

### RA 90+ SMD3528 Series

#### Product Features

1. RA 90+, conform to the requirement of supplementary lighting.
2. Abundant CCT option: 2700K|3000K|3500K|4000K|5000K|6500K.
3. 60LEDs/96LEDs/112LEDs/120LEDs/180LEDs/182LEDs/238LEDs/240LEDs per meter for option.
4. 8MM,10MM,14MM FPC width for option.
5. White,brown,black FPC for option,but our standard FPC color is white.
6. Low consumption, excellent and reliable stability.
7. Long lifetime (>50 000h).



**Color**

**Input DC Voltage**  
24VDC | 12VDC

**LED Type**  
SMD3528

2700 K	3000 K	3500 K
4000 K	5000 K	6500 K

**LED Qty. per meter**  
240 | 238 | 182 | 180  
120 | 112 | 96 | 60

**IP Index**  
IP 20 | IP54 | IP65  
IP67 | IP68

Model	CCT Wave lengths	Chip Size (mil)	Luminous Flux@20mA		I <sub>f</sub>		CRI(Ra)
			Min.	Max.	Current	Max.	
<b>SMD3528</b> 	2700K	8x15	7LM	9LM	20mA	30mA	90+
	3000K	8x15	7LM	9LM	20mA	30mA	90+
	3500K	8x15	7LM	9LM	20mA	30mA	90+
	4000K	8x15	7LM	9LM	20mA	30mA	90+
	5000K	8x15	7LM	9LM	20mA	30mA	90+
	6500K	8x15	7LM	9LM	20mA	30mA	90+
	620-625 NM NM	8x15	---	---	20mA	30mA	---
	585-590 NM NM	8x15	---	---	20mA	30mA	---
	517-522 NM NM	8x15	---	---	20mA	30mA	---
	465-470 NM NM	8x15	---	---	20mA	30mA	---

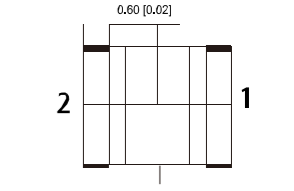
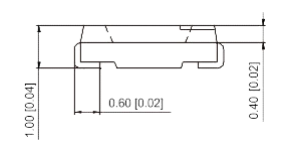
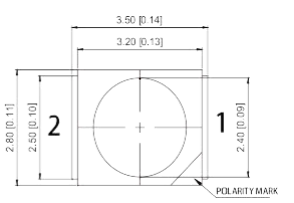

LED Strip Light

LED Strip Light Accessory

Aluminum Profile

LED Linear Luminaire

LED Panel Light

LED Panel Light Accessory

LED Strip Light

LED Strip Light Accessory

Aluminum Profile

LED Linear Luminaire

LED Panel Light

LED Panel Light Accessory

# Economy--RA 90+ SMD3528

## Part Number:ES-FS3528C-240-24-Y

Model	Color temp. Wave lengths	LM/M	Power/M	CRI (Ra)	FPC copper
ES-FS3528WW-240-24-Y	2700K	1564LM	<19.2W	90+	3OZ
ES-FS3528WW-240-24-Y	3000K	1564LM	<19.2W	90+	3OZ
ES-FS3528WW-240-24-Y	3500K	1564LM	<19.2W	90+	3OZ
ES-FS3528NW-240-24-Y	4000K	1600LM	<19.2W	90+	3OZ
ES-FS3528NW-240-24-Y	5000K	1600LM	<19.2W	90+	3OZ
ES-FS3528PW-240-24-Y	6500K	1650LM	<19.2W	90+	3OZ
ES-FS3528R-240-24-Y	620-625 NM NM	---	<19.2W	---	3OZ
ES-FS3528Y-240-24-Y	585-590 NM NM	---	<19.2W	---	3OZ
ES-FS3528G-240-24-Y	517-522 NM NM	---	<19.2W	---	3OZ
ES-FS3528B-240-24-Y	465-470 NM NM	---	<19.2W	---	3OZ

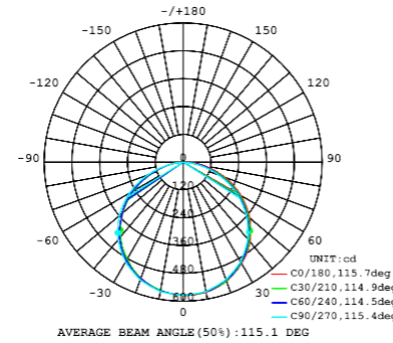

Strip length: CE:500CM UL:16.4FT

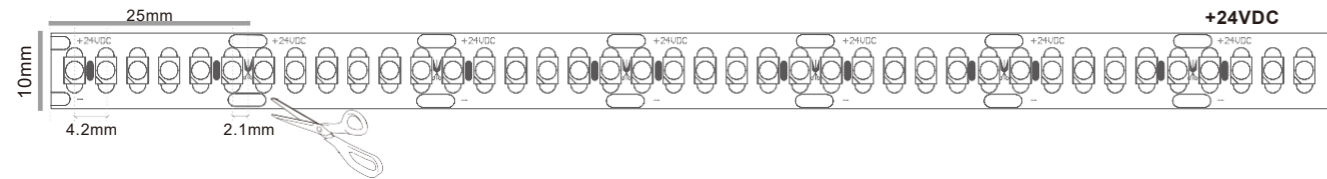

### IP Rating:

- IP20---Non waterproof
- IP54---Nano coated
- IP65---Silicon coated
- IP67---Silicon coated & Wrapped heat shrink tube
- IP67---PVC extrusion
- IP67---Silicon extrusion
- IP67---Silicon tube(transparent)
- IP68---Silicon tube(transparent) & Inject silicon glue

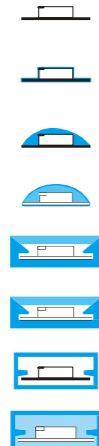

### AL. profiles (mm)



# Economy--RA 90+ SMD3528

## Part Number:ES-FS3528C-240H-24-Y

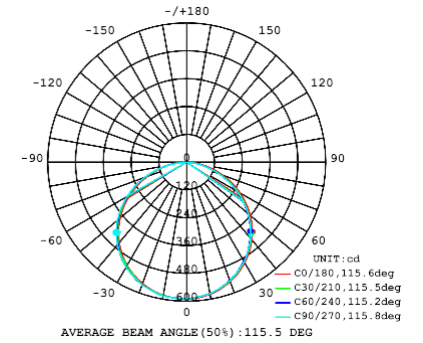
Model	Color temp. Wave lengths	LM/M	Power/M	CRI (Ra)	FPC copper
ES-FS3528WW-240H-24-Y	2700K	1564LM	<19.2W	90+	3OZ
ES-FS3528WW-240H-24-Y	3000K	1564LM	<19.2W	90+	3OZ
ES-FS3528WW-240H-24-Y	3500K	1564LM	<19.2W	90+	3OZ
ES-FS3528NW-240H-24-Y	4000K	1600LM	<19.2W	90+	3OZ
ES-FS3528NW-240H-24-Y	5000K	1600LM	<19.2W	90+	3OZ
ES-FS3528PW-240H-24-Y	6500K	1650LM	<19.2W	90+	3OZ
ES-FS3528R-240H-24-Y	620-625 NM NM	---	<19.2W	---	3OZ
ES-FS3528Y-240H-24-Y	585-590 NM NM	---	<19.2W	---	3OZ
ES-FS3528G-240H-24-Y	517-522 NM NM	---	<19.2W	---	3OZ
ES-FS3528B-240H-24-Y	465-470 NM NM	---	<19.2W	---	3OZ

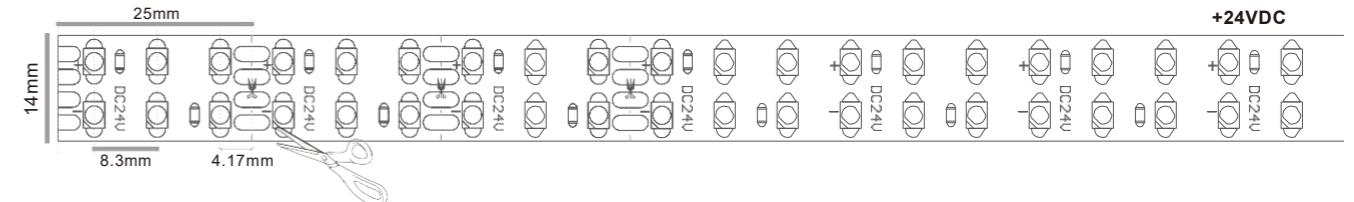

Strip length: CE:500CM UL:16.4FT



### IP Rating:

- IP20---Non waterproof
- IP54---Nano coated
- IP65---Silicon coated
- IP67---Silicon coated & Wrapped heat shrink tube
- IP67---PVC extrusion
- IP67---Silicon extrusion
- IP67---Silicon tube(transparent)
- IP68---Silicon tube(transparent) & Inject silicon glue

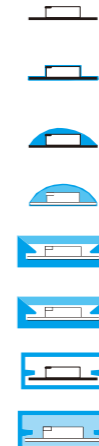

### AL. profiles (mm)

# Connector with cables

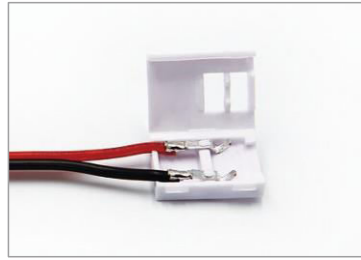

Suitable for SMD3528/2835, one meter with 240LED or 238LED  
 Item: ES-FS3528C-240-24-Y, ES-FS3528C-238-24-Y, ES-FS2835C-240-24-Y  
 Max. Current: 4A

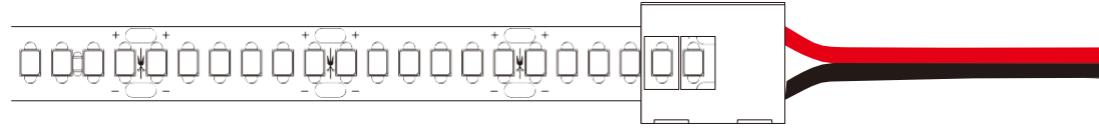

# Economy--RA 90+ SMD3528

Part Number: ES-FS3528C-238-24-Y

Model	Color temp. Wave lengths	LM/M	Power/M	Light efficiency	CRI (Ra)	FPC copper
ES-FS3528WW-238-24-Y	2700K	1939LM	<19.2W	101LM/W	90+	30Z
ES-FS3528WW-238-24-Y	3000K	2035LM	<19.2W	106LM/W	90+	30Z
ES-FS3528WW-238-24-Y	3500K	2035LM	<19.2W	106LM/W	90+	30Z
ES-FS3528NW-238-24-Y	4000K	2112LM	<19.2W	110LM/W	90+	30Z
ES-FS3528NW-238-24-Y	5000K	2112LM	<19.2W	110LM/W	90+	30Z
ES-FS3528PW-238-24-Y	6500K	2169LM	<19.2W	113LM/W	90+	30Z
ES-FS3528R-238-24-Y	620-625 NM NM	---	<19.2W	---	---	30Z
ES-FS3528Y-238-24-Y	585-590 NM NM	---	<19.2W	---	---	30Z
ES-FS3528G-238-24-Y	517-522 NM NM	---	<19.2W	---	---	30Z
ES-FS3528B-238-24-Y	465-470 NM NM	---	<19.2W	---	---	30Z

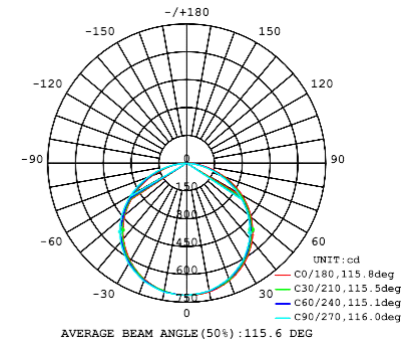

Strip length: CE:500CM UL:16.4FT

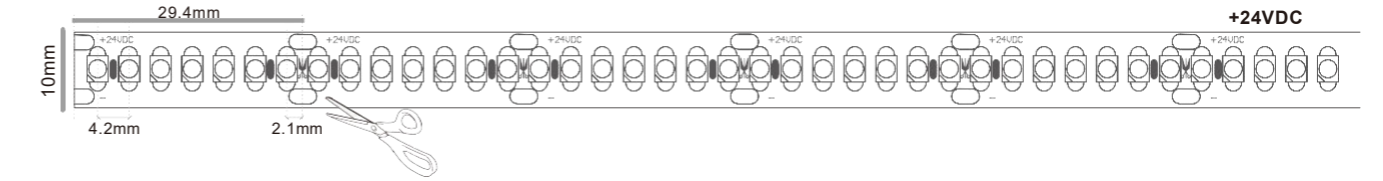

### IP Rating:

- IP20---Non waterproof
- IP54---Nano coated
- IP65---Silicon coated
- IP67---Silicon coated & Wrapped heat shrink tube
- IP67---PVC extrusion
- IP67---Silicon extrusion
- IP67---Silicon tube(transparent)
- IP68---Silicon tube(transparent) & Inject silicon glue

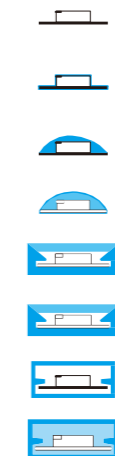

### AL. profiles (mm)

LED Strip Light

LED Strip Light Accessory

Aluminum Profile

LED Linear Luminaire

LED Panel Light

LED Panel Light Accessory

LED Strip Light

LED Strip Light Accessory

Aluminum Profile

LED Linear Luminaire

LED Panel Light

LED Panel Light Accessory



# Economy--RA 90+ SMD3528

Part Number:ES-FS3528C-182-24-Y

Model	Color temp. Wave lengths	LM/M	Power/M	Light efficiency	CRI (Ra)	FPC copper
ES-FS3528WW-182-24-Y	2700K	1454LM	<14.4W	101LM/W	90+	3OZ
ES-FS3528WW-182-24-Y	3000K	1526LM	<14.4W	106LM/W	90+	3OZ
ES-FS3528WW-182-24-Y	3500K	1526LM	<14.4W	106LM/W	90+	3OZ
ES-FS3528NW-182-24-Y	4000K	1580LM	<14.4W	110LM/W	90+	3OZ
ES-FS3528NW-182-24-Y	5000K	1580LM	<14.4W	110LM/W	90+	3OZ
ES-FS3528PW-182-24-Y	6500K	1627LM	<14.4W	113LM/W	90+	3OZ
ES-FS3528R-182-24-Y	620-625 NM NM	---	<14.4W	---	---	3OZ
ES-FS3528Y-182-24-Y	585-590 NM NM	---	<14.4W	---	---	3OZ
ES-FS3528G-182-24-Y	517-522 NM NM	---	<14.4W	---	---	3OZ
ES-FS3528B-182-24-Y	465-470 NM NM	---	<14.4W	---	---	3OZ

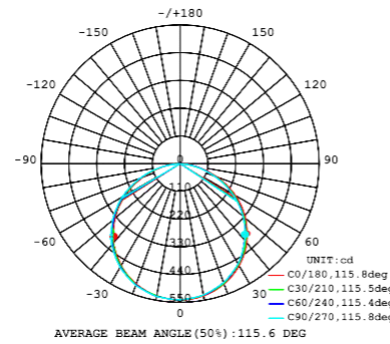

Strip length: CE:500CM UL:16.4FT

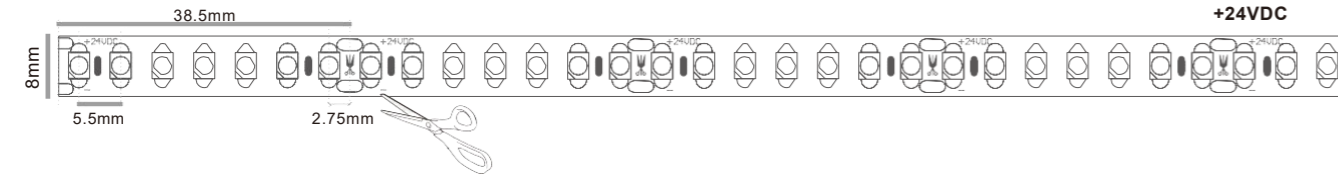

### AL. profiles (mm)

ES-LL017009	ES-LL024011	ES-LL017015	ES-LL013006
ES-LL023009	ES-LL030011	ES-LL023015	ES-LL013012
ES-LL016016	ES-LL020020-1	ES-LL025019	ES-LL025025
ES-LL030030	ES-LL010015	ES-LL025046	
ES-LL057011	ES-LL064014		

### IP Rating:

- IP20---Non waterproof
- IP54---Nano coated
- IP65---Silicon coated
- IP67---Silicon coated & Wrapped heat shrink tube
- IP67---PVC extrusion
- IP67---Silicon extrusion
- IP67---Silicon tube(transparent)
- IP68---Silicon tube(transparent) & Inject silicon glue

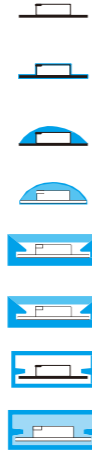

# Economy--RA 90+ SMD3528

Part Number:ES-FS3528C-180-24-Y  
Part Number:ES-FS3528C-180-12-Y

Model	Color temp. Wave lengths	LM/M	Power/M	CRI (Ra)	FPC copper
ES-FS3528WW-180-24-Y	2700K	1026LM	<14.4W	90+	3OZ
ES-FS3528WW-180-24-Y	3000K	1026LM	<14.4W	90+	3OZ
ES-FS3528WW-180-24-Y	3500K	1026LM	<14.4W	90+	3OZ
ES-FS3528NW-180-24-Y	4000K	1100LM	<14.4W	90+	3OZ
ES-FS3528NW-180-24-Y	5000K	1100LM	<14.4W	90+	3OZ
ES-FS3528PW-180-24-Y	6500K	1150LM	<14.4W	90+	3OZ
ES-FS3528R-180-24-Y	620-625 NM NM	---	<14.4W	---	3OZ
ES-FS3528Y-180-24-Y	585-590 NM NM	---	<14.4W	---	3OZ
ES-FS3528G-180-24-Y	517-522 NM NM	---	<14.4W	---	3OZ
ES-FS3528B-180-24-Y	465-470 NM NM	---	<14.4W	---	3OZ

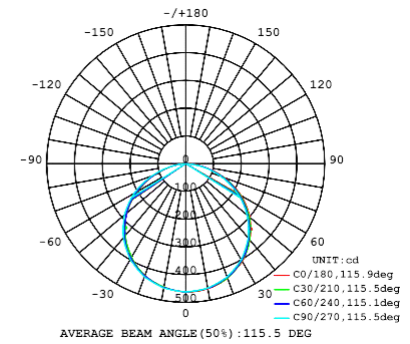

Strip length: CE:500CM UL:22.63FT(24V) | 13.12FT(12V)

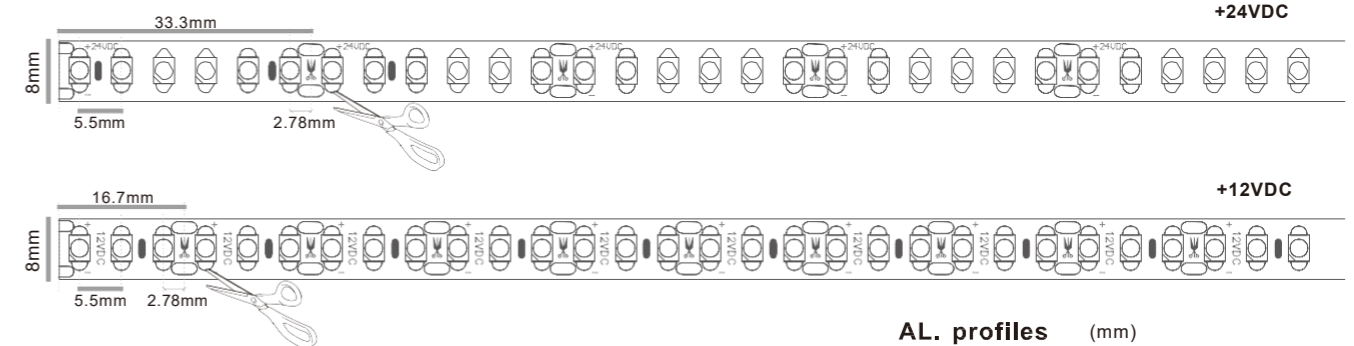

### AL. profiles (mm)

ES-LL017009	ES-LL024011	ES-LL017015	ES-LL013006
ES-LL023009	ES-LL030011	ES-LL023015	ES-LL013012
ES-LL016016	ES-LL020020-1	ES-LL025019	ES-LL025025
ES-LL030030	ES-LL010015	ES-LL025046	
ES-LL057011	ES-LL064014		

### IP Rating:

- IP20---Non waterproof
- IP54---Nano coated
- IP65---Silicon coated
- IP67---Silicon coated & Wrapped heat shrink tube
- IP67---PVC extrusion
- IP67---Silicon extrusion
- IP67---Silicon tube(transparent)
- IP68---Silicon tube(transparent) & Inject silicon glue

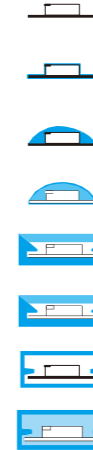

# Economy--RA 90+ SMD3528

Part Number:ES-FS3528C-120-24-Y  
Part Number:ES-FS3528C-120-12-Y

Model	Color temp. Wave lengths	LM/M	Power/M	CRI (Ra)	FPC copper
ES-FS3528WW-120-24-Y	2700K	740LM	<9.6W	90+	3OZ
ES-FS3528WW-120-24-Y	3000K	740LM	<9.6W	90+	3OZ
ES-FS3528WW-120-24-Y	3500K	740LM	<9.6W	90+	3OZ
ES-FS3528NW-120-24-Y	4000K	768LM	<9.6W	90+	3OZ
ES-FS3528NW-120-24-Y	5000K	768LM	<9.6W	90+	3OZ
ES-FS3528PW-120-24-Y	6500K	780LM	<9.6W	90+	3OZ
ES-FS3528R-120-24-Y	620-625 NM NM	---	<9.6W	---	3OZ
ES-FS3528Y-120-24-Y	585-590 NM NM	---	<9.6W	---	3OZ
ES-FS3528G-120-24-Y	517-522 NM NM	---	<9.6W	---	3OZ
ES-FS3528B-120-24-Y	465-470 NM NM	---	<9.6W	---	3OZ

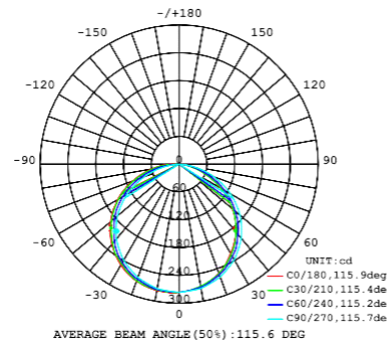

Strip length: CE:500CM UL:32.8FT(24V) | 19.69FT(12V)

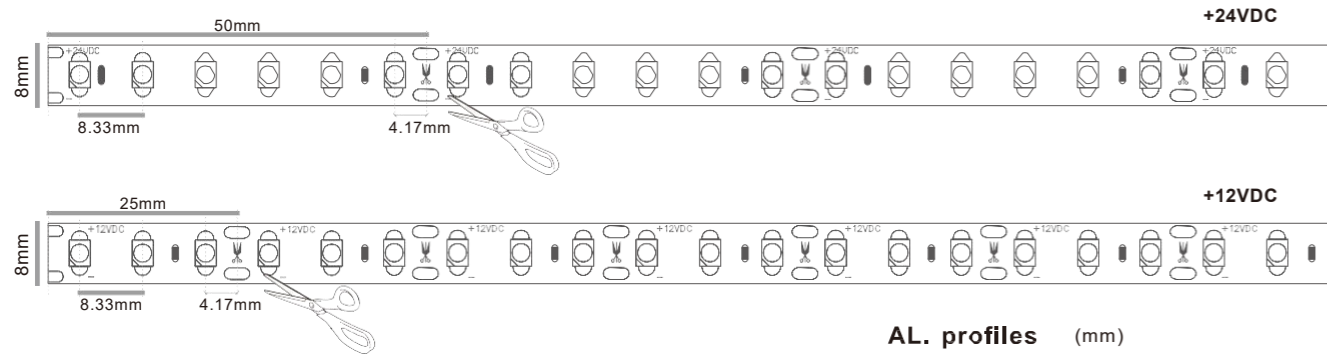

### IP Rating:

- IP20---Non waterproof
- IP54---Nano coated
- IP65---Silicon coated
- IP67---Silicon coated & Wrapped heat shrink tube
- IP67---PVC extrusion
- IP67---Silicon extrusion
- IP67---Silicon tube(transparent)
- IP68---Silicon tube(transparent) & Inject silicon glue

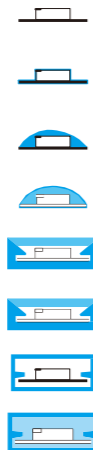

### AL. profiles (mm)

ES-LL017009	ES-LL024011	ES-LL017015	ES-LL013006
ES-LL023009	ES-LL030011	ES-LL023015	ES-LL013012
ES-LL016016	ES-LL020020-1	ES-LL025019	ES-LL025025
ES-LL030030	ES-LL010015	ES-LL025046	
ES-LL057011	ES-LL064014		

# Economy--RA 90+ SMD3528

Part Number:ES-FS3528C-112-24-Y

Model	Color temp. Wave lengths	LM/M	Power/M	Light efficiency	CRI (Ra)	FPC copper
ES-FS3528WW-112-24-Y	2700K	873LM	<9.6W	91LM/W	90+	3OZ
ES-FS3528WW-112-24-Y	3000K	920LM	<9.6W	96LM/W	90+	3OZ
ES-FS3528WW-112-24-Y	3500K	920LM	<9.6W	96LM/W	90+	3OZ
ES-FS3528NW-112-24-Y	4000K	969LM	<9.6W	101LM/W	90+	3OZ
ES-FS3528NW-112-24-Y	5000K	969LM	<9.6W	101LM/W	90+	3OZ
ES-FS3528PW-112-24-Y	6500K	980LM	<9.6W	103LM/W	90+	3OZ
ES-FS3528R-112-24-Y	620-625 NM NM	---	<9.6W	---	---	3OZ
ES-FS3528Y-112-24-Y	585-590 NM NM	---	<9.6W	---	---	3OZ
ES-FS3528G-112-24-Y	517-522 NM NM	---	<9.6W	---	---	3OZ
ES-FS3528B-112-24-Y	465-470 NM NM	---	<9.6W	---	---	3OZ

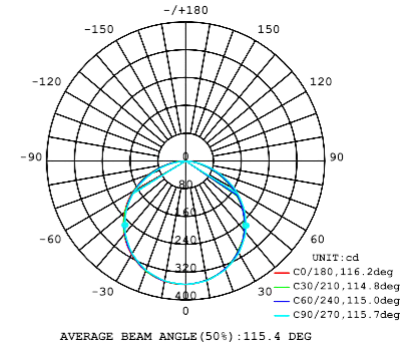

Strip length: CE:500CM UL:34.18FT

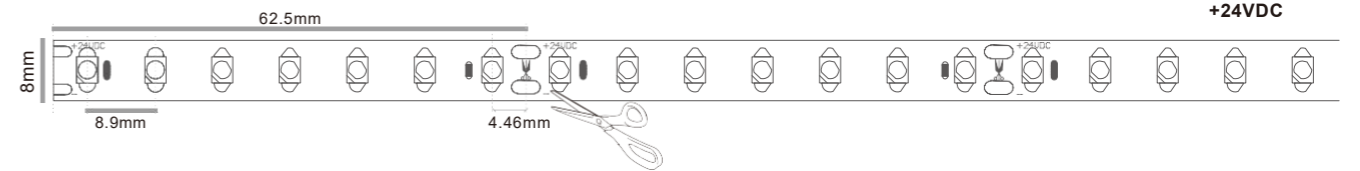

### IP Rating:

- IP20---Non waterproof
- IP54---Nano coated
- IP65---Silicon coated
- IP67---Silicon coated & Wrapped heat shrink tube
- IP67---PVC extrusion
- IP67---Silicon extrusion
- IP67---Silicon tube(transparent)
- IP68---Silicon tube(transparent) & Inject silicon glue

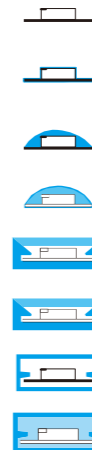

### AL. profiles (mm)

ES-LL017009	ES-LL024011	ES-LL017015	ES-LL013006
ES-LL023009	ES-LL030011	ES-LL023015	ES-LL013012
ES-LL016016	ES-LL020020-1	ES-LL025019	ES-LL025025
ES-LL030030	ES-LL010015	ES-LL025046	
ES-LL057011	ES-LL064014		

# Economy--RA 90+ SMD3528

Part Number:ES-FS3528C-96-24-Y  
Part Number:ES-FS3528C-96-12-Y

Model	Color temp. Wave lengths	LM/M	Power/M	CRI (Ra)	FPC copper
ES-FS3528WW-96-24-Y	2700K	430LM	<7.68W	90+	3OZ
ES-FS3528WW-96-24-Y	3000K	430LM	<7.68W	90+	3OZ
ES-FS3528WW-96-24-Y	3500K	430LM	<7.68W	90+	3OZ
ES-FS3528NW-96-24-Y	4000K	480LM	<7.68W	90+	3OZ
ES-FS3528NW-96-24-Y	5000K	530LM	<7.68W	90+	3OZ
ES-FS3528PW-96-24-Y	6500K	500LM	<7.68W	90+	3OZ
ES-FS3528R-96-24-Y	620-625 NM NM	---	<7.68W	---	3OZ
ES-FS3528Y-96-24-Y	585-590 NM NM	---	<7.68W	---	3OZ
ES-FS3528G-96-24-Y	517-522 NM NM	---	<7.68W	---	3OZ
ES-FS3528B-96-24-Y	465-470 NM NM	---	<7.68W	---	3OZ

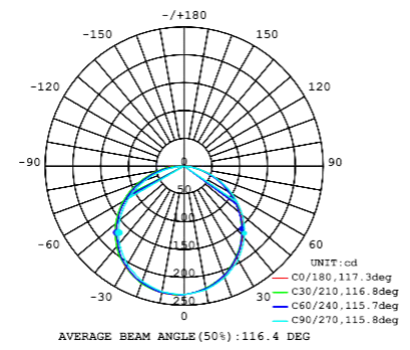
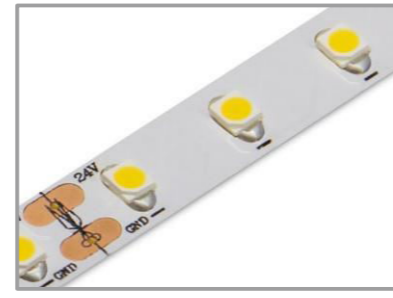

Strip length: CE:500CM UL:47.57FT(24V) | 26.25FT(12V)

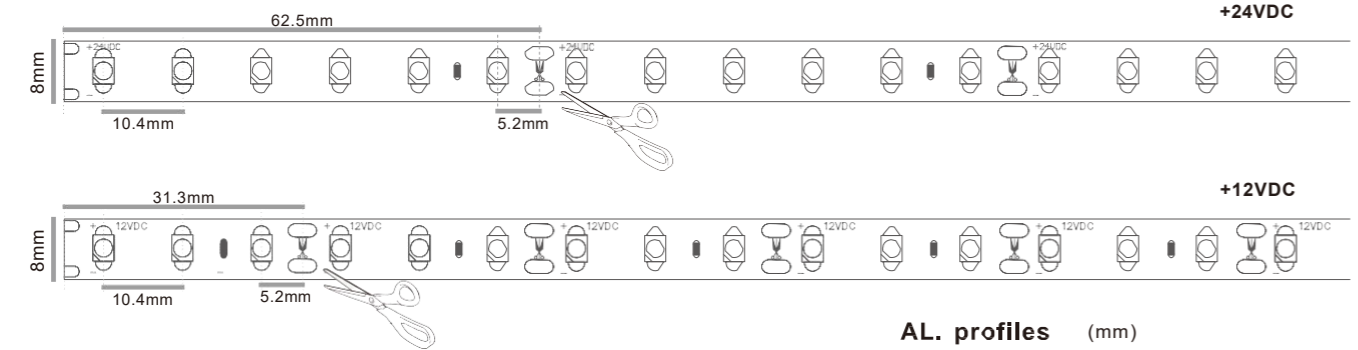

- IP Rating:**
- IP20---Non waterproof
  - IP54---Nano coated
  - IP65---Silicon coated
  - IP67---Silicon coated & Wrapped heat shrink tube
  - IP67---PVC extrusion
  - IP67---Silicon extrusion
  - IP67---Silicon tube(transparent)
  - IP68---Silicon tube(transparent) & Inject silicon glue

**AL. profiles (mm)**

ES-LL017009	ES-LL024011	ES-LL017015	ES-LL013006
ES-LL023009	ES-LL030011	ES-LL023015	ES-LL013012
ES-LL016016	ES-LL020020-1	ES-LL025019	ES-LL025025
ES-LL030030	ES-LL010015	ES-LL025046	
ES-LL057011	ES-LL064014		

# Economy--RA 90+ SMD3528

Part Number:ES-FS3528C-60-12-Y  
Part Number:ES-FS3528C-60-24-Y

Model	Color temp. Wave lengths	LM/M	Power/M	CRI (Ra)	FPC copper
ES-FS3528WW-60-12-Y	2700K	360LM	<4.8W	90+	2OZ
ES-FS3528WW-60-12-Y	3000K	360LM	<4.8W	90+	2OZ
ES-FS3528WW-60-12-Y	3500K	360LM	<4.8W	90+	2OZ
ES-FS3528NW-60-12-Y	4000K	390LM	<4.8W	90+	2OZ
ES-FS3528NW-60-12-Y	5000K	390LM	<4.8W	90+	2OZ
ES-FS3528PW-60-12-Y	6500K	400LM	<4.8W	90+	2OZ
ES-FS3528R-60-12-Y	620-625 NM NM	---	<4.8W	---	2OZ
ES-FS3528Y-60-12-Y	585-590 NM NM	---	<4.8W	---	2OZ
ES-FS3528G-60-12-Y	517-522 NM NM	---	<4.8W	---	2OZ
ES-FS3528B-60-12-Y	465-470 NM NM	---	<4.8W	---	2OZ

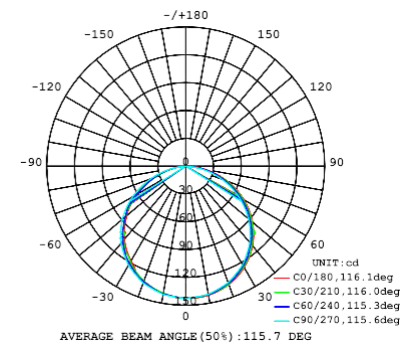
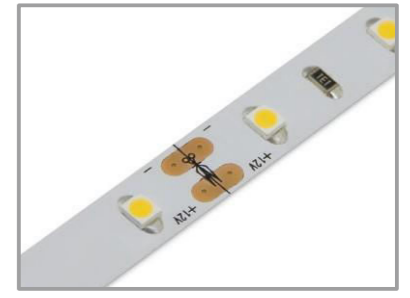

Strip length: CE:500CM UL:41FT(12V) | 60.7FT(24V)

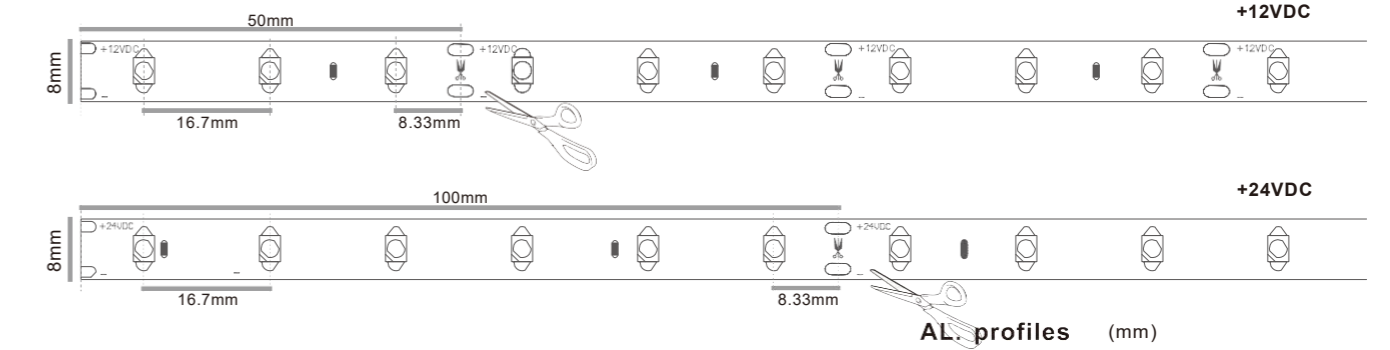

- IP Rating:**
- IP20---Non waterproof
  - IP54---Nano coated
  - IP65---Silicon coated
  - IP67---Silicon coated & Wrapped heat shrink tube
  - IP67---PVC extrusion
  - IP67---Silicon extrusion
  - IP67---Silicon tube(transparent)
  - IP68---Silicon tube(transparent) & Inject silicon glue

**AL. profiles (mm)**

ES-LL017009	ES-LL024011	ES-LL017015	ES-LL013006
ES-LL023009	ES-LL030011	ES-LL023015	ES-LL013012
ES-LL016016	ES-LL020020-1	ES-LL025019	ES-LL025025
ES-LL030030	ES-LL010015	ES-LL025046	
ES-LL057011	ES-LL064014		

## Connect Instructions

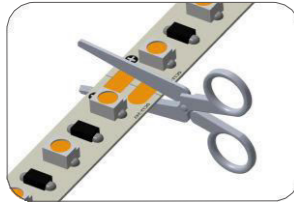

Unfold the LED strip, and cut into the required length according to the direction of the scissors.

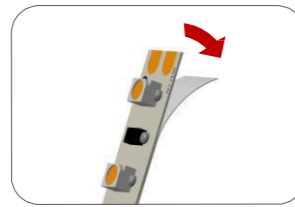

Peel away 3M tape from the cutting edge.



Fold the transparent cover to 90° (45° for high density strip).

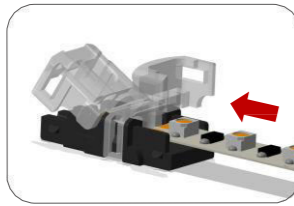

Insert LED tape light, and press the transparent cover to lock with both bottoms of connector. (Attention: LED tape light should fit with the top of PIN).

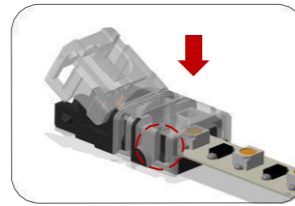

Installation of connecting tape-to-tape finished; As for connecting tape-to-tape, please use the same method.

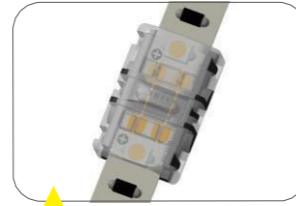

⚠ Keep the positive and negative pole one-to-one correspondence while in connecting.

## Connect Instructions for Wire-to-Connector

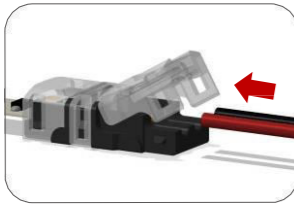

Cut wires into the length required, and keep the insulation, then insert into guide-groove.



⚠ Attention: Keep the positive and negative pole one-to-one correspondence while connecting wire with tape.

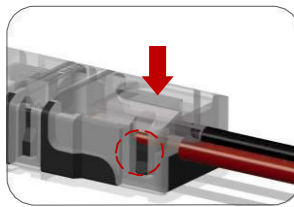

Use an electric plier to lock the transparent cover with both bottoms of connector.



Installation finished.

### Power on but no light ?

Please try following tests to identify:

Cables: whether could be match with the LED tape light;

Positive and negative pole: whether connected accurately with LED tape light;

PCB: whether the PCB's thickness is enough to hold such power;

Distance of pad: whether it's too far away from the metal plate;

Check the integrity of LED tape light.

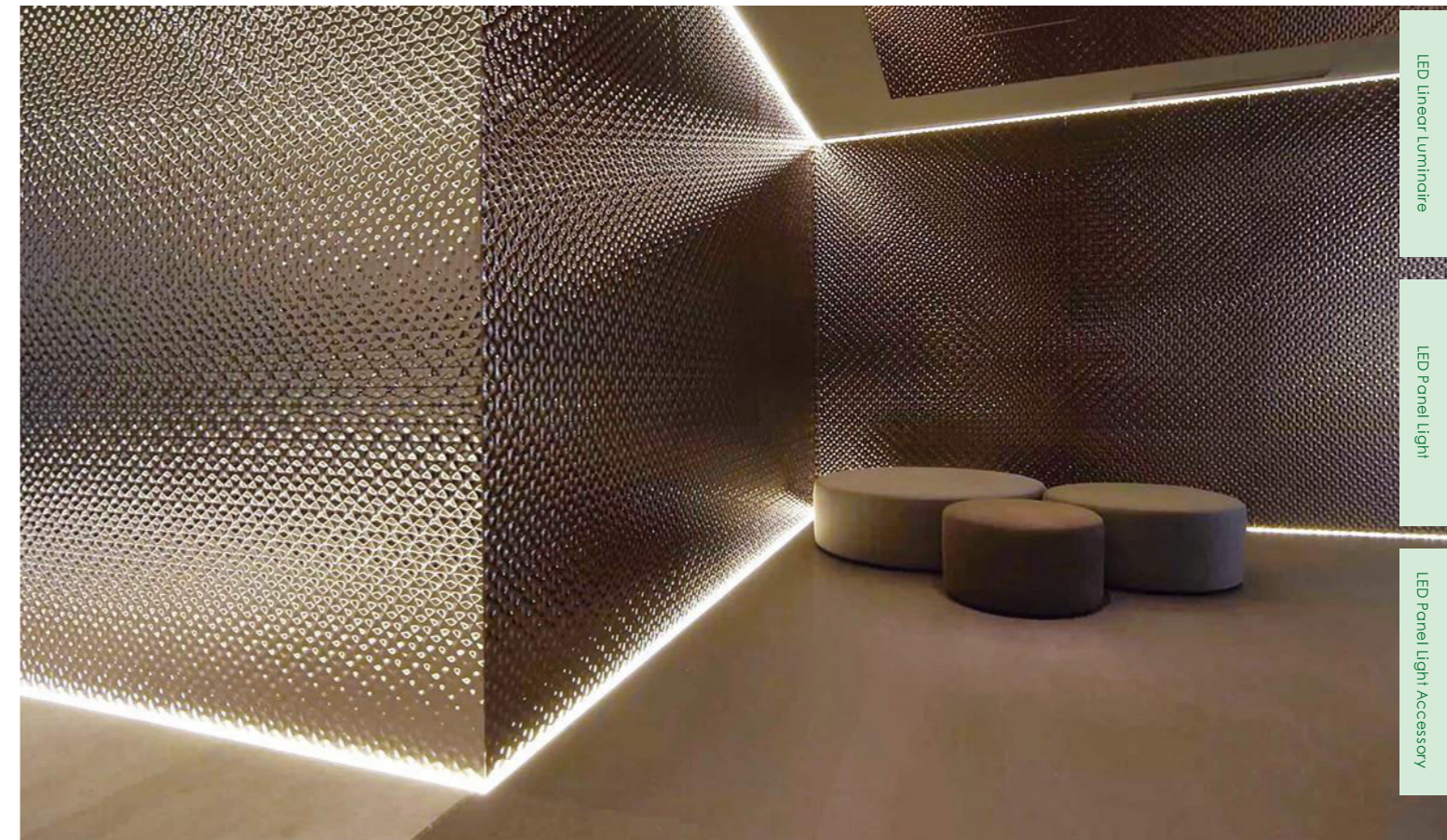
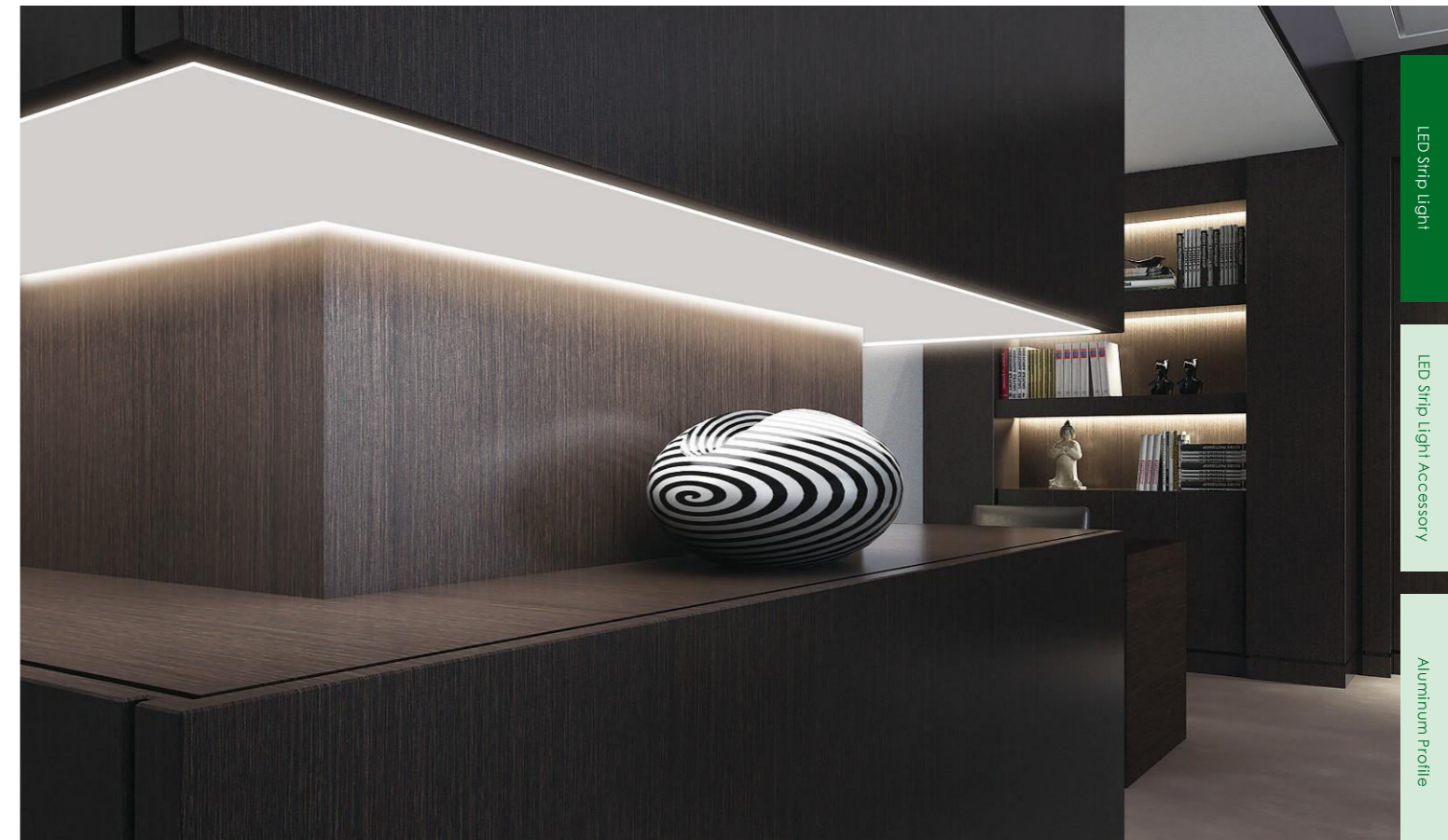

# SMD5050 Series

RA 90+

## Product Features

1. RA 90+, conform to the requirement of supplementary lighting.
2. Abundant CCT option: 2700K|3000K|4000K|5000K|6500K.
3. 30LEDs/60LEDs/72LEDs/96LEDs/120LEDs per meter for option.
4. 10MM,12MM,18MM FPC width for option.
5. White,brown,black FPC for option,but our standard FPC color is white.
6. Low consumption, excellent and reliable stability.
7. Long lifetime (>50 000h),3 chips inside.

# ES-FS5050C-120-24-Y

① ② ③ ④ ⑤

Color

Input DC Voltage

24VDC | 12VDC

LED Type  
SMD5050

2700 K 3000 K 4000 K 5000 K 6500 K

LED Qty. per meter  
120 | 96 | 72 | 60 | 30

IP Index  
IP 20 | IP54 | IP65  
IP67 | IP68

Model	Color temp. Wave lengths	Chip Size (mil)	Luminous Flux@60mA		I <sub>F</sub>		CRI(Ra)
			Min.	Max.	Current	Max.	
SMD5050 	2700K	8x15	20LM	22LM	---	60mA	90+
	3000K	8x15	20LM	22LM	---	60mA	90+
	4000K	8x15	20LM	22LM	---	60mA	90+
	5000K	8x15	20LM	22LM	---	60mA	90+
	6500K	8x15	20LM	22LM	---	60mA	90+
	620-625 NM NM	8x15	20LM	---	---	60mA	---
	585-590 NM NM	8x15	20LM	---	---	60mA	---
	517-522 NM NM	8x15	20LM	---	---	60mA	---
	465-470 NM NM	8x15	20LM	---	---	60mA	---

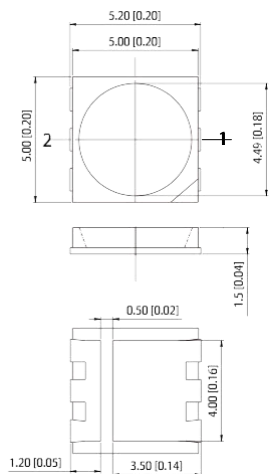

LED Strip Light

LED Strip Light Accessory

Aluminum Profile

LED Linear Luminaire

LED Panel Light

LED Panel Light Accessory

LED Strip Light

LED Strip Light Accessory

Aluminum Profile

LED Linear Luminaire

LED Panel Light

LED Panel Light Accessory

# RA 90+ SMD5050 Series

Part Number:ES-FS5050C-120H-24-Y

Model	Color temp. Wave lengths	LM/M	Power/M	CRI (Ra)	FPC copper
ES-FS5050WW-120H-24-Y	2700K	1815LM	<23W	90+	3OZ
ES-FS5050WW-120H-24-Y	3000K	1815LM	<23W	90+	3OZ
ES-FS5050NW-120H-24-Y	4000K	1985LM	<23W	90+	3OZ
ES-FS5050NW-120H-24-Y	5000K	1985LM	<23W	90+	3OZ
ES-FS5050PW-120H-24-Y	6500K	2015LM	<23W	90+	3OZ
ES-FS5050R-120H-24-Y	620-625 NM NM	---	<23W	---	3OZ
ES-FS5050Y-120H-24-Y	585-590 NM NM	---	<23W	---	3OZ
ES-FS5050G-120H-24-Y	517-522 NM NM	---	<23W	---	3OZ
ES-FS5050B-120H-24-Y	465-470 NM NM	---	<23W	---	3OZ

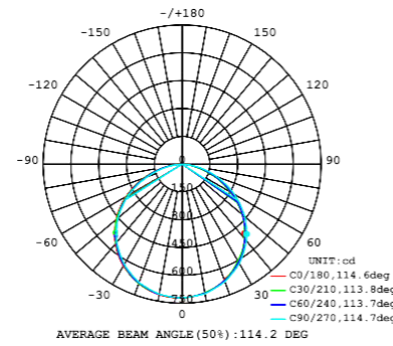

Strip length: CE:500CM UL:13.12FT

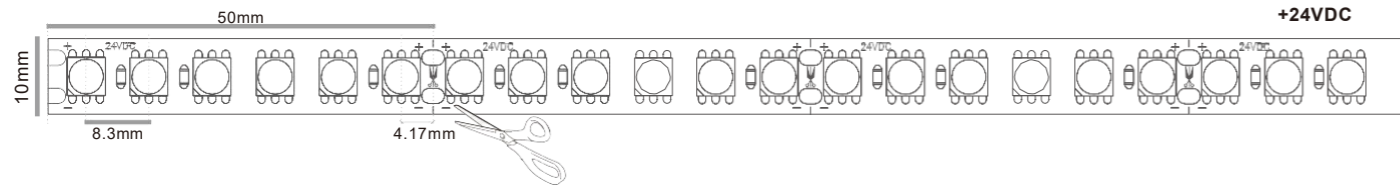

### IP Rating:

- IP20---Non waterproof
- IP54---Nano coated
- IP65---Silicon coated
- IP67---Silicon coated & Wrapped heat shrink tube
- IP67---PVC extrusion
- IP67---Silicon extrusion
- IP67---Silicon tube(transparent)
- IP68---Silicon tube(transparent) & Inject silicon glue

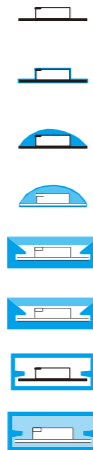

### AL. profiles (mm)

ES-LL017009	ES-LL024011	ES-LL017015	ES-LL013006
ES-LL023009	ES-LL030011	ES-LL023015	ES-LL013012
ES-LL016016	ES-LL020020-1	ES-LL025019	ES-LL025025
ES-LL030030	ES-LL010015	ES-LL025046	
ES-LL057011	ES-LL064014		

# RA 90+ SMD5050 Series

Part Number:ES-FS5050C-120-24-Y

Model	Color temp. Wave lengths	LM/M	Power/M	CRI (Ra)	FPC copper
ES-FS5050WW-120-24-Y	2700K	1835LM	<26W	90+	3OZ
ES-FS5050WW-120-24-Y	3000K	1835LM	<26W	90+	3OZ
ES-FS5050NW-120-24-Y	4000K	1915LM	<26W	90+	3OZ
ES-FS5050NW-120-24-Y	5000K	1915LM	<26W	90+	3OZ
ES-FS5050PW-120-24-Y	6500K	2043LM	<26W	90+	3OZ
ES-FS5050R-120-24-Y	620-625 NM NM	---	<26W	---	3OZ
ES-FS5050Y-120-24-Y	585-590 NM NM	---	<26W	---	3OZ
ES-FS5050G-120-24-Y	517-522 NM NM	---	<26W	---	3OZ
ES-FS5050B-120-24-Y	465-470 NM NM	---	<26W	---	3OZ

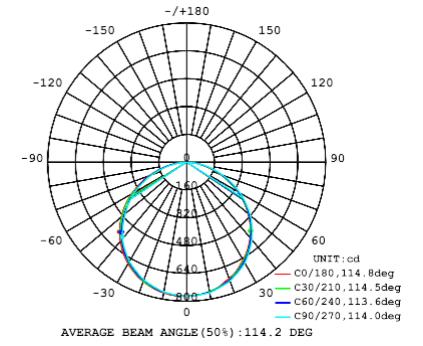
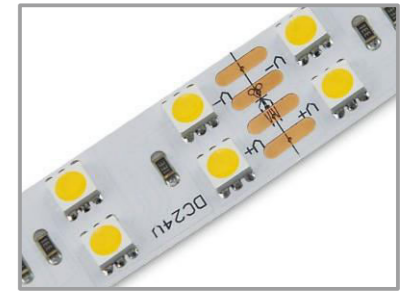

Strip length: CE:500CM UL:11.48FT

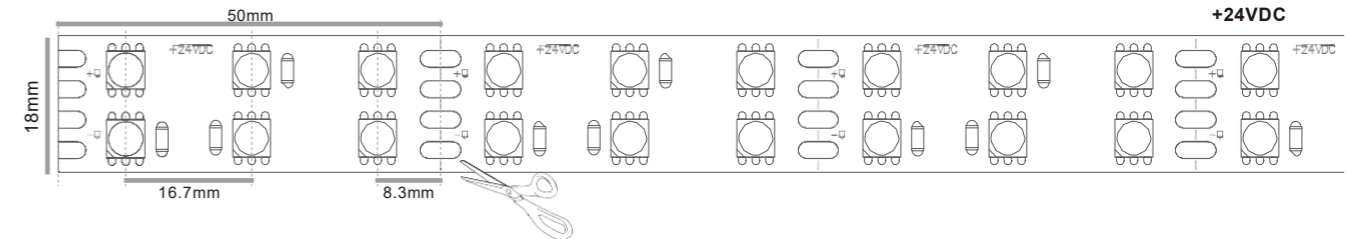

### IP Rating:

- IP20---Non waterproof
- IP54---Nano coated
- IP65---Silicon coated
- IP67---Silicon coated & Wrapped heat shrink tube
- IP67---PVC extrusion
- IP67---Silicon extrusion
- IP67---Silicon tube(transparent)
- IP68---Silicon tube(transparent) & Inject silicon glue

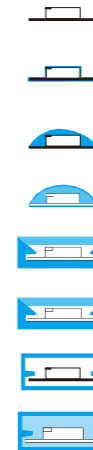

### AL. profiles (mm)

ES-LL017009	ES-LL024011	ES-LL017015	ES-LL013006
ES-LL023009	ES-LL030011	ES-LL023015	ES-LL013012
ES-LL016016	ES-LL020020-1	ES-LL025019	ES-LL025025
ES-LL030030	ES-LL010015	ES-LL025046	
ES-LL057011	ES-LL064014		

# RA 90+ SMD5050 Series

Part Number: ES-FS5050C-96-24-Y

Model	Color temp. Wave lengths	LM/M	Power/M	CRI (Ra)	FPC copper
ES-FS5050WW-96-24-Y	2700K	1625LM	<23W	90+	3OZ
ES-FS5050WW-96-24-Y	3000K	1625LM	<23W	90+	3OZ
ES-FS5050NW-96-24-Y	4000K	1717LM	<23W	90+	3OZ
ES-FS5050NW-96-24-Y	5000K	1717LM	<23W	90+	3OZ
ES-FS5050PW-96-24-Y	6500K	1809LM	<23W	90+	3OZ
ES-FS5050R-96-24-Y	620-625 NM NM	---	<23W	---	3OZ
ES-FS5050Y-96-24-Y	585-590 NM NM	---	<23W	---	3OZ
ES-FS5050G-96-24-Y	517-522 NM NM	---	<23W	---	3OZ
ES-FS5050B-96-24-Y	465-470 NM NM	---	<23W	---	3OZ

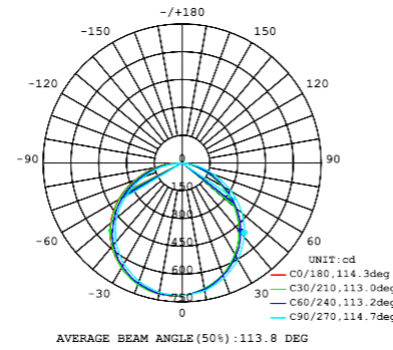

Strip length: CE:500CM UL:14.23FT

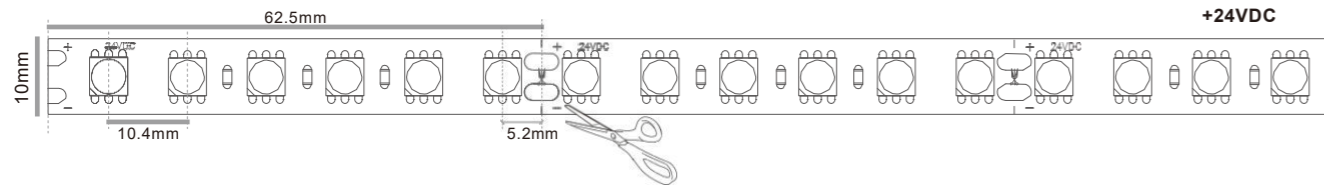

### IP Rating:

- IP20---Non waterproof
- IP54---Nano coated
- IP65---Silicon coated
- IP67---Silicon coated & Wrapped heat shrink tube
- IP67---PVC extrusion
- IP67---Silicon extrusion
- IP67---Silicon tube(transparent)
- IP68---Silicon tube(transparent) & Inject silicon glue

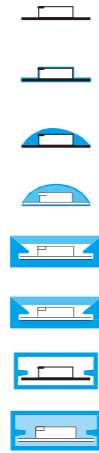

### AL. profiles (mm)

<del>ES-LL017009</del>	ES-LL024011	<del>ES-LL017015</del>	<del>ES-LL013006</del>
<del>ES-LL023009</del>	ES-LL030011	<del>ES-LL023015</del>	<del>ES-LL013012</del>
<del>ES-LL016016</del>	ES-LL020020-1	<del>ES-LL025019</del>	ES-LL025025
ES-LL030030	<del>ES-LL010015</del>	ES-LL025046	
<del>ES-LL057011</del>	ES-LL064014		

# RA 90+ SMD5050 Series

Part Number: ES-FS5050C-72-12-Y  
Part Number: ES-FS5050C-72-24-Y

Model	Color temp. Wave lengths	LM/M	Power/M	CRI (Ra)	FPC copper
ES-FS5050WW-72-12-Y	2700K	1065LM	<17.2W	90+	3OZ
ES-FS5050WW-72-12-Y	3000K	1065LM	<17.2W	90+	3OZ
ES-FS5050NW-72-12-Y	4000K	1105LM	<17.2W	90+	3OZ
ES-FS5050NW-72-12-Y	5000K	1105LM	<17.2W	90+	3OZ
ES-FS5050PW-72-12-Y	6500K	1215LM	<17.2W	90+	3OZ
ES-FS5050R-72-12-Y	620-625 NM NM	---	<17.2W	---	3OZ
ES-FS5050Y-72-12-Y	585-590 NM NM	---	<17.2W	---	3OZ
ES-FS5050G-72-12-Y	517-522 NM NM	---	<17.2W	---	3OZ
ES-FS5050B-72-12-Y	465-470 NM NM	---	<17.2W	---	3OZ

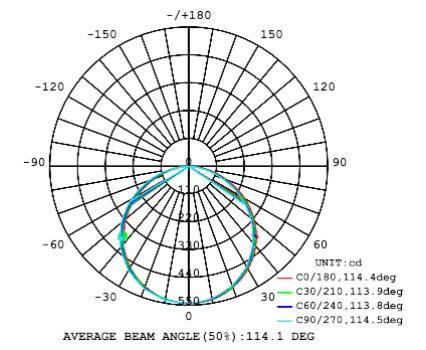
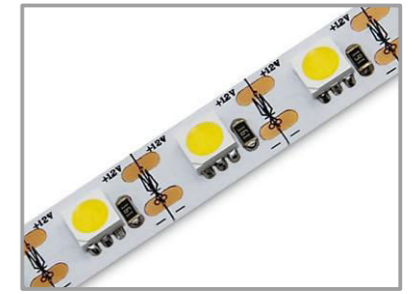

Strip length: CE:500CM UL:13.12FT(12V) | 19.69FT(24V)

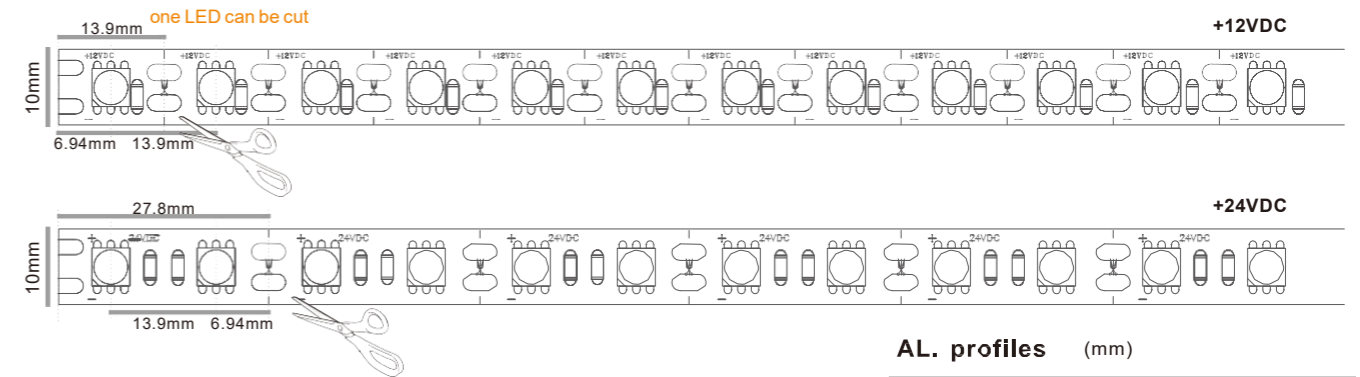

### IP Rating:

- IP20---Non waterproof
- IP54---Nano coated
- IP65---Silicon coated
- IP67---Silicon coated & Wrapped heat shrink tube
- IP67---PVC extrusion
- IP67---Silicon extrusion
- IP67---Silicon tube(transparent)
- IP68---Silicon tube(transparent) & Inject silicon glue

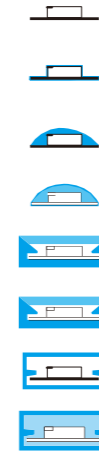

### AL. profiles (mm)

<del>ES-LL017009</del>	ES-LL024011	<del>ES-LL017015</del>	<del>ES-LL013006</del>
<del>ES-LL023009</del>	ES-LL030011	<del>ES-LL023015</del>	<del>ES-LL013012</del>
<del>ES-LL016016</del>	ES-LL020020-1	<del>ES-LL025019</del>	ES-LL025025
ES-LL030030	<del>ES-LL010015</del>	ES-LL025046	
<del>ES-LL057011</del>	ES-LL064014		

# RA 90+ SMD5050 Series

Part Number:ES-FS5050C-60-24-Y  
Part Number:ES-FS5050C-60-12-Y

Model	Color temp. Wave lengths	LM/M	Power/M	CRI (Ra)	FPC copper
ES-FS5050WW-60-24-Y	2700K	1035LM	<14.4W	90+	3OZ
ES-FS5050WW-60-24-Y	3000K	1035LM	<14.4W	90+	3OZ
ES-FS5050NW-60-24-Y	4000K	1065LM	<14.4W	90+	3OZ
ES-FS5050NW-60-24-Y	5000K	1065LM	<14.4W	90+	3OZ
ES-FS5050PW-60-24-Y	6500K	1093LM	<14.4W	90+	3OZ
ES-FS5050R-60-24-Y	620-625 NM NM	---	<14.4W	---	3OZ
ES-FS5050Y-60-24-Y	585-590 NM NM	---	<14.4W	---	3OZ
ES-FS5050G-60-24-Y	517-522 NM NM	---	<14.4W	---	3OZ
ES-FS5050B-60-24-Y	465-470 NM NM	---	<14.4W	---	3OZ

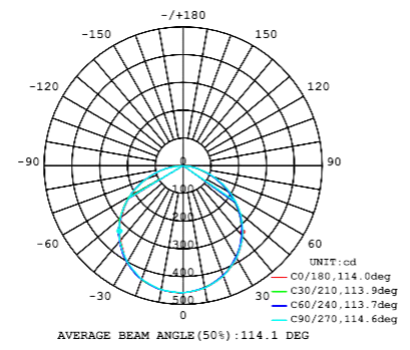
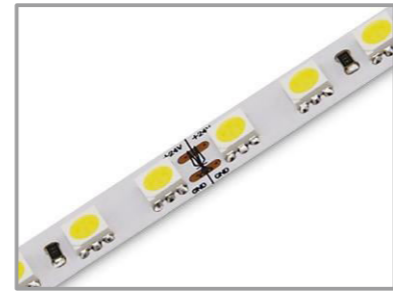

Strip length: CE:500CM UL:22.63FT(24V) | 13.12FT(12V)

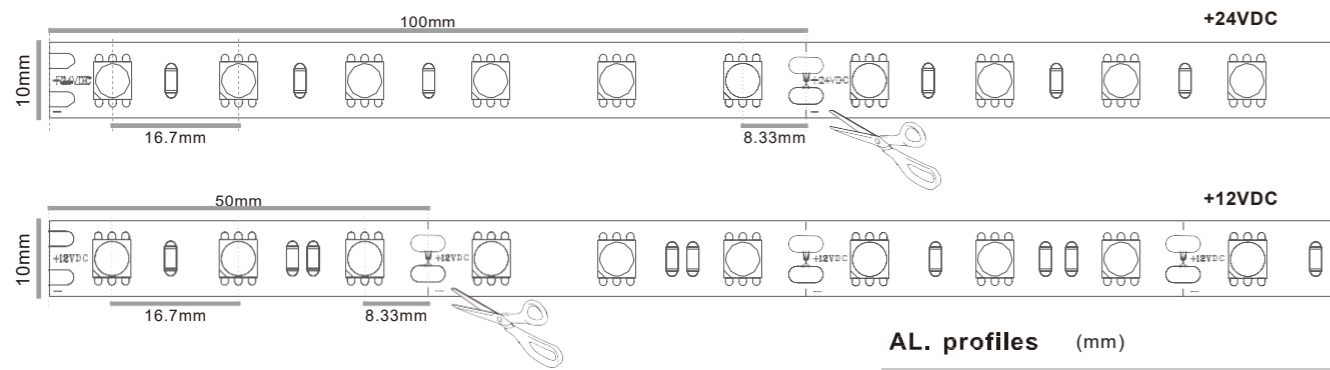

- IP Rating:**
- IP20---Non waterproof
  - IP54---Nano coated
  - IP65---Silicon coated
  - IP67---Silicon coated & Wrapped heat shrink tube
  - IP67---PVC extrusion
  - IP67---Silicon extrusion
  - IP67---Silicon tube(transparent)
  - IP68---Silicon tube(transparent) & Inject silicon glue

**AL. profiles (mm)**

ES-LL017009	ES-LL024011	ES-LL017015	ES-LL013006
ES-LL023009	ES-LL030011	ES-LL023015	ES-LL013012
ES-LL016016	ES-LL020020-1	ES-LL025019	ES-LL025025
ES-LL030030	ES-LL010015	ES-LL025046	
ES-LL057011	ES-LL064014		

# RA 90+ SMD5050 Series

Part Number:ES-FS5050C-30-12-Y  
Part Number:ES-FS5050C-30-24-Y

Model	Color temp. Wave lengths	LM/M	Power/M	CRI (Ra)	FPC copper
ES-FS5050WW-30-12-Y	2700K	519LM	<7.2W	90+	2OZ
ES-FS5050WW-30-12-Y	3000K	519LM	<7.2W	90+	2OZ
ES-FS5050NW-30-12-Y	4000K	547LM	<7.2W	90+	2OZ
ES-FS5050NW-30-12-Y	5000K	547LM	<7.2W	90+	2OZ
ES-FS5050PW-30-12-Y	6500K	576LM	<7.2W	90+	2OZ
ES-FS5050R-30-12-Y	620-625 NM NM	---	<7.2W	---	2OZ
ES-FS5050Y-30-12-Y	585-590 NM NM	---	<7.2W	---	2OZ
ES-FS5050G-30-12-Y	517-522 NM NM	---	<7.2W	---	2OZ
ES-FS5050B-30-12-Y	465-470 NM NM	---	<7.2W	---	2OZ

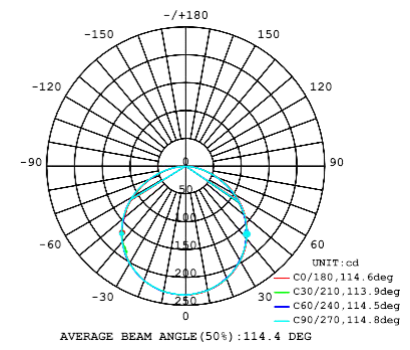

Strip length: CE:500CM UL:16.4FT(12V) | 22.97FT(24V)

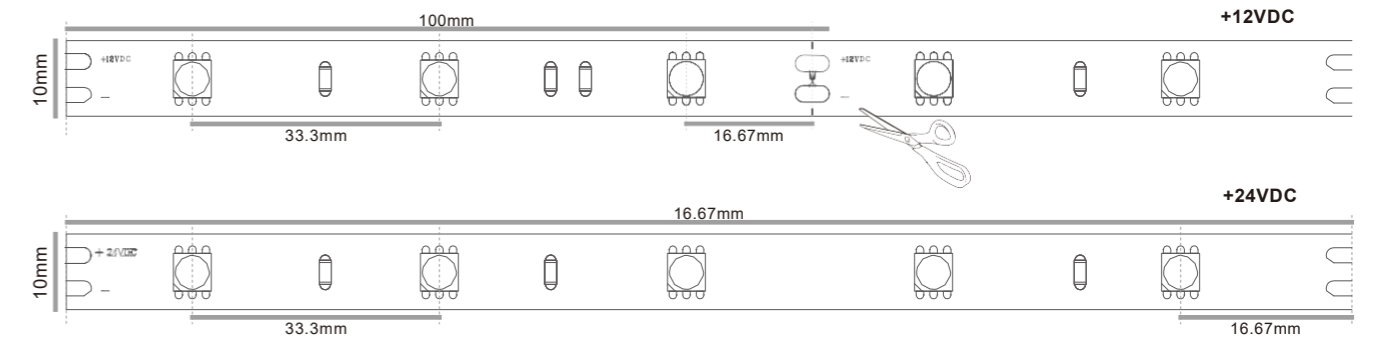

- IP Rating:**
- IP20---Non waterproof
  - IP54---Nano coated
  - IP65---Silicon coated
  - IP67---Silicon coated & Wrapped heat shrink tube
  - IP67---PVC extrusion
  - IP67---Silicon extrusion
  - IP67---Silicon tube(transparent)
  - IP68---Silicon tube(transparent) & Inject silicon glue

**AL. profiles (mm)**

ES-LL017009	ES-LL024011	ES-LL017015	ES-LL013006
ES-LL023009	ES-LL030011	ES-LL023015	ES-LL013012
ES-LL016016	ES-LL020020-1	ES-LL025019	ES-LL025025
ES-LL030030	ES-LL010015	ES-LL025046	
ES-LL057011	ES-LL064014		



## ⚠️ Cautions:



Straighten the LED strip vertically during normal service.



Straighten the LED strip parallelly during normal service.

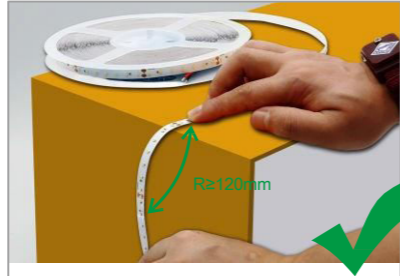

During normal service, once need a turning, must hold the curve of LED strip with its front side up and back side down.  
(Attention: keep the curved radian  $\geq 120\text{mm}$ )

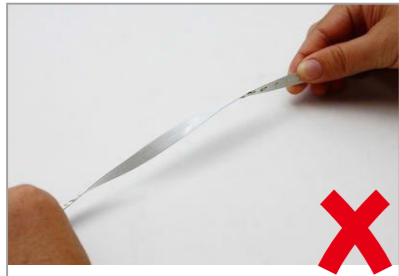

The LED strip can not be distorted during normal service.

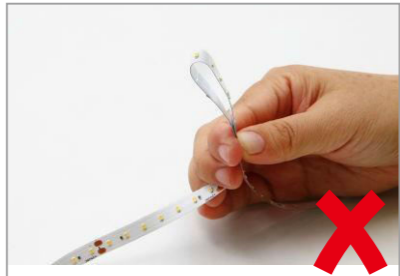

The curvature can not be  $\leq 90$  during normal service.



The LED strip can not be removed all from the reel, then install from the front end.

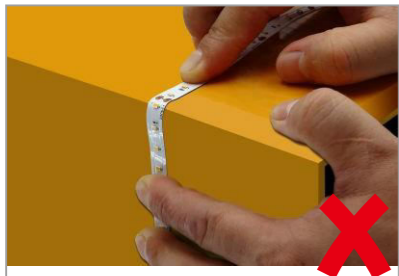

During normal service, once need a turning, must hold the curve of LED strip with its front side up and back side down.  
(Attention: The curvature can not be  $\leq 120\text{mm}$ )

- Do not connect the low voltage LED Tape Light 12V or 24V directly to 220V. In this case, the LEDs will be instantly destroyed!
- If LED Tape Light with cables on both sides, please attention: when connect one side to the driver, make sure the other side cables (negative and positive) stay disconnected. Otherwise, the LED Tape Light will be in short circuit and increase risk of damaging the LED Tape Light.
- LED Tape Light is electrostatic and sensitive device, please wear the anti-static wrist strap or the anti-static glove when touch or use it.



**MULTICOLOR**



# RGB Series

## Product Features

1. Low-voltage 24VDC and 12VDC, 100% safe.
2. Energy-saving, eco-friendly, anti-UV and no optical radiation
3. SMD5050, SMD3535.
4. Controlled by RGB controller with colorful effects.

# ES-FS3535RGB-120-24-Y

①

②

③

④

⑤

1

### LED Type

SMD5050 | SMD3535

2

### Color

620-627  
NM NM525-530  
NM NM470-475  
NM NM

3

### LED Qty. per meter

120 | 112 | 96 | 60 | 30

4

### Input DC Voltage

24VDC | 12VDC

5

### IP Index

IP 20 | IP54 | IP65

IP67 | IP68

Model	Wave lengths	Chip Size (mil)	Luminous Flux@60mA		I <sub>F</sub>		CRI(Ra)
			Min.	Max.	Current	Max.	
SMD3535RGB	620-627 NM NM	9x9	8LM	10LM	---	60mA	---
	525-530 NM NM	10x12	8LM	10LM	---	60mA	---
	470-475 NM NM	10x12	8LM	10LM	---	60mA	---

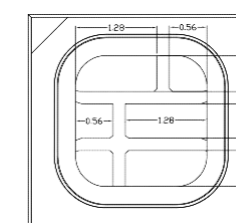
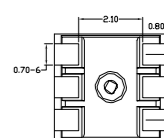
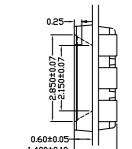
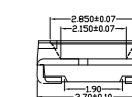
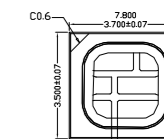

# RGB Series

Part Number:ES-FS3535RGB-120-24-Y



**Info.**

Model	Wave lengths	LM/M	Power/M	Strip length	Cuttable	FPC width	FPC copper	IP Rating
ES-FS3535RGB-120-24-Y(5mm)	620-627 NM NM 525-530 NM NM 470-475 NM NM	515LM	<12W	CE:500CM UL:22.97FT	50mm	5mm	3 ounce	IP20 IP54
ES-FS3535RGB-120-24-Y(8mm)	620-627 NM NM 525-530 NM NM 470-475 NM NM	570LM	<14.4W	CE:500CM UL:22.97FT	50mm	8mm	3 ounce	IP20 IP65 IP54 IP67 IP68
ES-FS3535RGB-120-24-Y(10mm)	620-627 NM NM 525-530 NM NM 470-475 NM NM	570LM	<14.4W	CE:500CM UL:22.97FT	50mm	10mm	3 ounce	IP20 IP65 IP54 IP67 IP68

**Controller**

Product No.	Description
4.02.127	12-24VDC 3A*3CH Max.9A 108W/216W(12V/24V)



**IP Rating:**

- IP20---Non waterproof
- IP54---Nano coated
- IP65---Silicon coated
- IP67---Silicon coated & Wrapped heat shrink tube
- IP67---PVC extrusion
- IP67---Silicon extrusion
- IP67---Silicon tube(transparent)
- IP68---Silicon tube(transparent) & Inject silicon glue

**AL. profiles (mm)**

ES-LL017009	ES-LL024011	ES-LL017015	ES-LL013006
ES-LL023009	ES-LL030011	ES-LL023015	ES-LL013012
ES-LL016016	ES-LL020020-1	ES-LL025019	ES-LL025025
ES-LL030030	ES-LL010015	ES-LL025046	
ES-LL057011	ES-LL064014		

# Super Bright RGB

Part Number:ES-FS3535RGB-112-24-Y

Model	Wave lengths	LM/M	Power/M	FPC copper
ES-FS3535RGB-112-24-Y	620-627 NM NM 525-530 NM NM 470-475 NM NM	1050LM	<19.2W	30Z



**Controller**

Product No.	Description
4.02.127	12-24VDC 3A*3CH Max.9A 108W/216W(12V/24V)

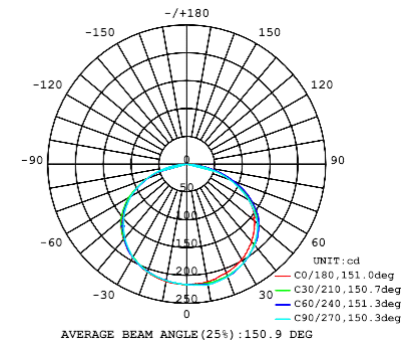

Strip length: CE:500CM UL:16.4FT

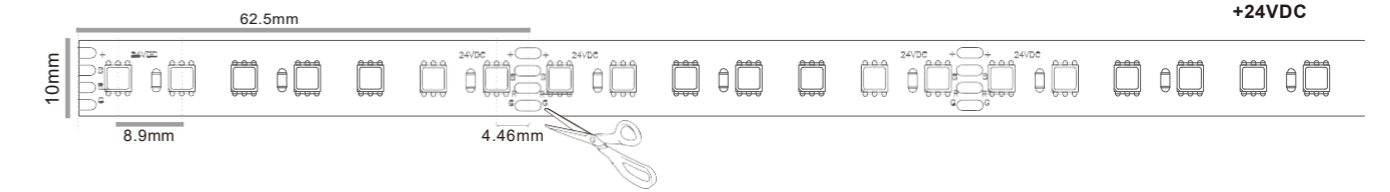

**IP Rating:**

- IP20---Non waterproof
- IP54---Nano coated
- IP65---Silicon coated
- IP67---Silicon coated & Wrapped heat shrink tube
- IP67---PVC extrusion
- IP67---Silicon extrusion
- IP67---Silicon tube(transparent)
- IP68---Silicon tube(transparent) & Inject silicon glue

**AL. profiles (mm)**

ES-LL017009	ES-LL024011	ES-LL017015	ES-LL013006
ES-LL023009	ES-LL030011	ES-LL023015	ES-LL013012
ES-LL016016	ES-LL020020-1	ES-LL025019	ES-LL025025
ES-LL030030	ES-LL010015	ES-LL025046	
ES-LL057011	ES-LL064014		

# RGB Series

Part Number:ES-FS5050RGB-96-24-Y

Model	Wave lengths	LM/M	Power/M	FPC copper
ES-FS5050RGB-96-24-Y	620-627 NM NM	780LM	<23W	30Z
	525-530 NM NM			
	470-475 NM NM			

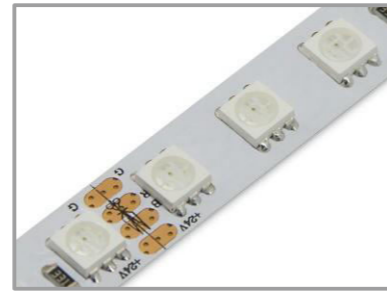

### Controller

Product No.	Description
4.02.127	12-24VDC 3A*3CH Max.9A 108W/216W(12V/24V)

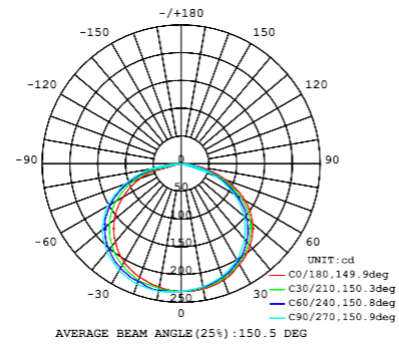

Strip length: CE:500CM UL:13.12FT

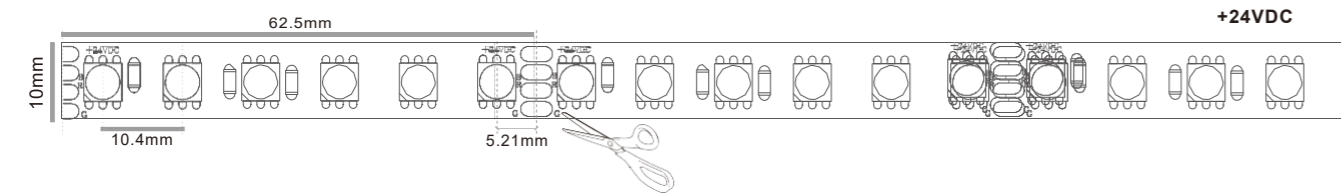

### IP Rating:

- IP20---Non waterproof
- IP54---Nano coated
- IP65---Silicon coated
- IP67---Silicon coated & Wrapped heat shrink tube
- IP67---PVC extrusion
- IP67---Silicon extrusion
- IP67---Silicon tube(transparent)
- IP68---Silicon tube(transparent) & Inject silicon glue

### AL. profiles (mm)

ES-LL017009	ES-LL024011	ES-LL017015	ES-LL013006
ES-LL023009	ES-LL030011	ES-LL023015	ES-LL013012
ES-LL016016	ES-LL020020-1	ES-LL025019	ES-LL025025
ES-LL030030	ES-LL010015	ES-LL025046	
ES-LL057011	ES-LL064014		

# RGB Series

Part Number:ES-FS5050RGB-60-24-Y

Part Number:ES-FS5050RGB-60-12-Y

Model	Wave lengths	LM/M	Power/M	FPC copper
ES-FS5050RGB-60-24-Y	620-627 NM NM	530LM	<14.4W	30Z
	525-530 NM NM			
	470-475 NM NM			



### Controller

Product No.	Description
4.02.127	12-24VDC 3A*3CH Max.9A 108W/216W(12V/24V)

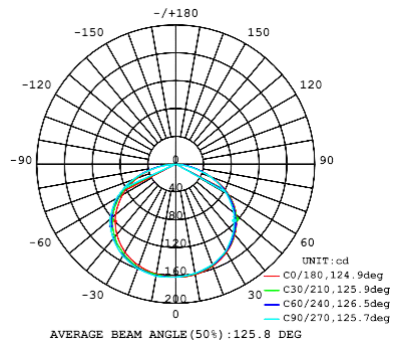

Strip length: CE:500CM UL:22.97FT(24V) | 13.12FT(12V)

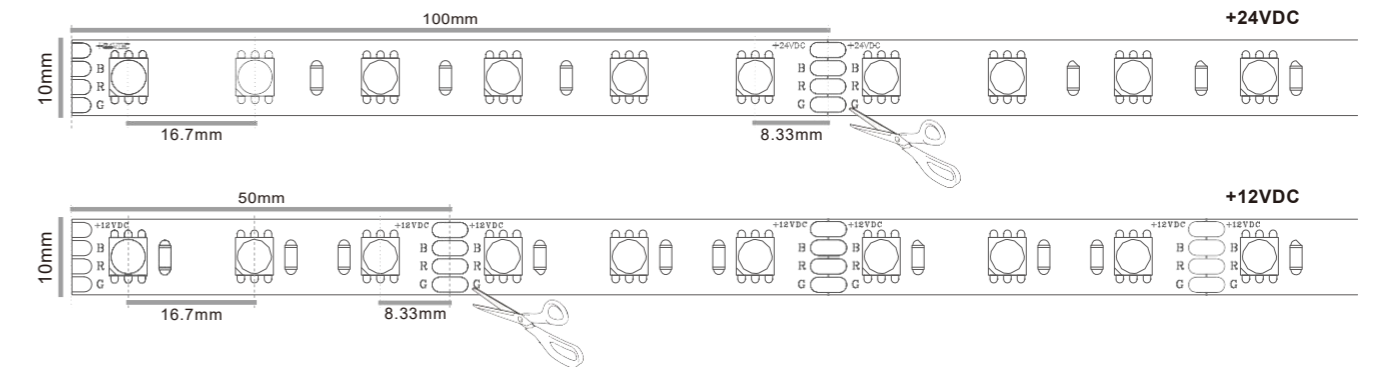

### IP Rating:

- IP20---Non waterproof
- IP54---Nano coated
- IP65---Silicon coated
- IP67---Silicon coated & Wrapped heat shrink tube
- IP67---PVC extrusion
- IP67---Silicon extrusion
- IP67---Silicon tube(transparent)
- IP68---Silicon tube(transparent) & Inject silicon glue

### AL. profiles (mm)

ES-LL017009	ES-LL024011	ES-LL017015	ES-LL013006
ES-LL023009	ES-LL030011	ES-LL023015	ES-LL013012
ES-LL016016	ES-LL020020-1	ES-LL025019	ES-LL025025
ES-LL030030	ES-LL010015	ES-LL025046	
ES-LL057011	ES-LL064014		

# RGB Series

Part Number:ES-FS5050RGB-30-12-Y  
 Part Number:ES-FS5050RGB-30-24-Y

Model	Wave lengths	LM/M	Power/M	FPC copper
ES-FS5050RGB-30-12-Y	620-627 NM NM	230LM	<7.2W	20Z
	525-530 NM NM			
	470-475 NM NM			



### Controller

Product No.	Description
4.02.127	12-24VDC 3A*3CH Max.9A 108W/216W(12V/24V)

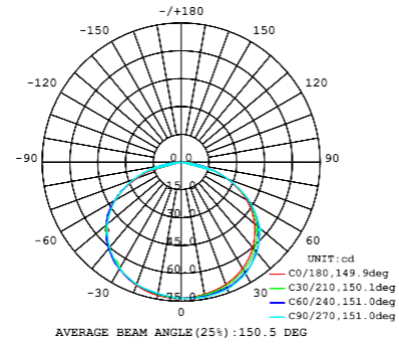

Strip length: CE:500CM UL:27.89FT(12V) | 22.97FT(24V)

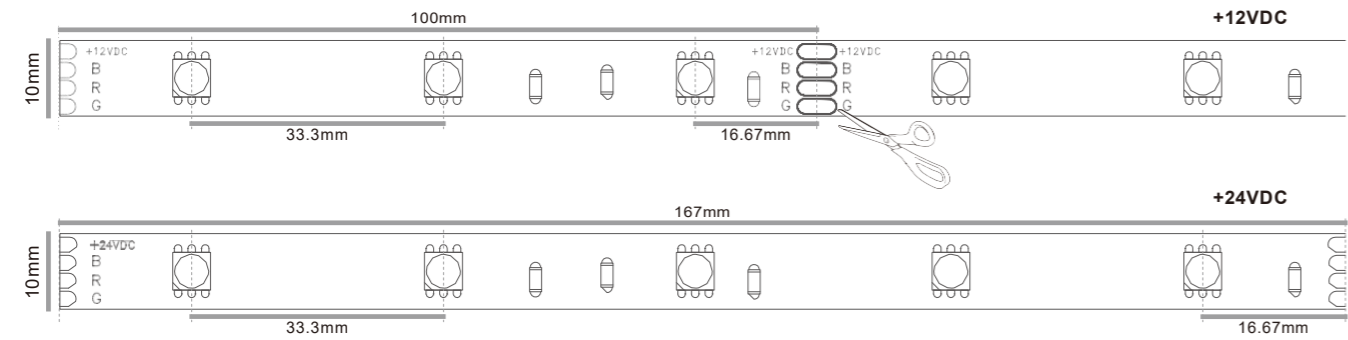

### IP Rating:

- IP20---Non waterproof
- IP54---Nano coated
- IP65---Silicon coated
- IP67---Silicon coated & Wrapped heat shrink tube
- IP67---PVC extrusion
- IP67---Silicon extrusion
- IP67---Silicon tube(transparent)
- IP68---Silicon tube(transparent) & Inject silicon glue

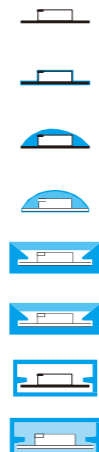

### AL. profiles (mm)

ES-LL017009	ES-LL024011	ES-LL017015	ES-LL013006
ES-LL023009	ES-LL030011	ES-LL023015	ES-LL013012
ES-LL016016	ES-LL020020-1	ES-LL025019	ES-LL025025
ES-LL030030	ES-LL010015	ES-LL025046	
ES-LL057011	ES-LL064014		

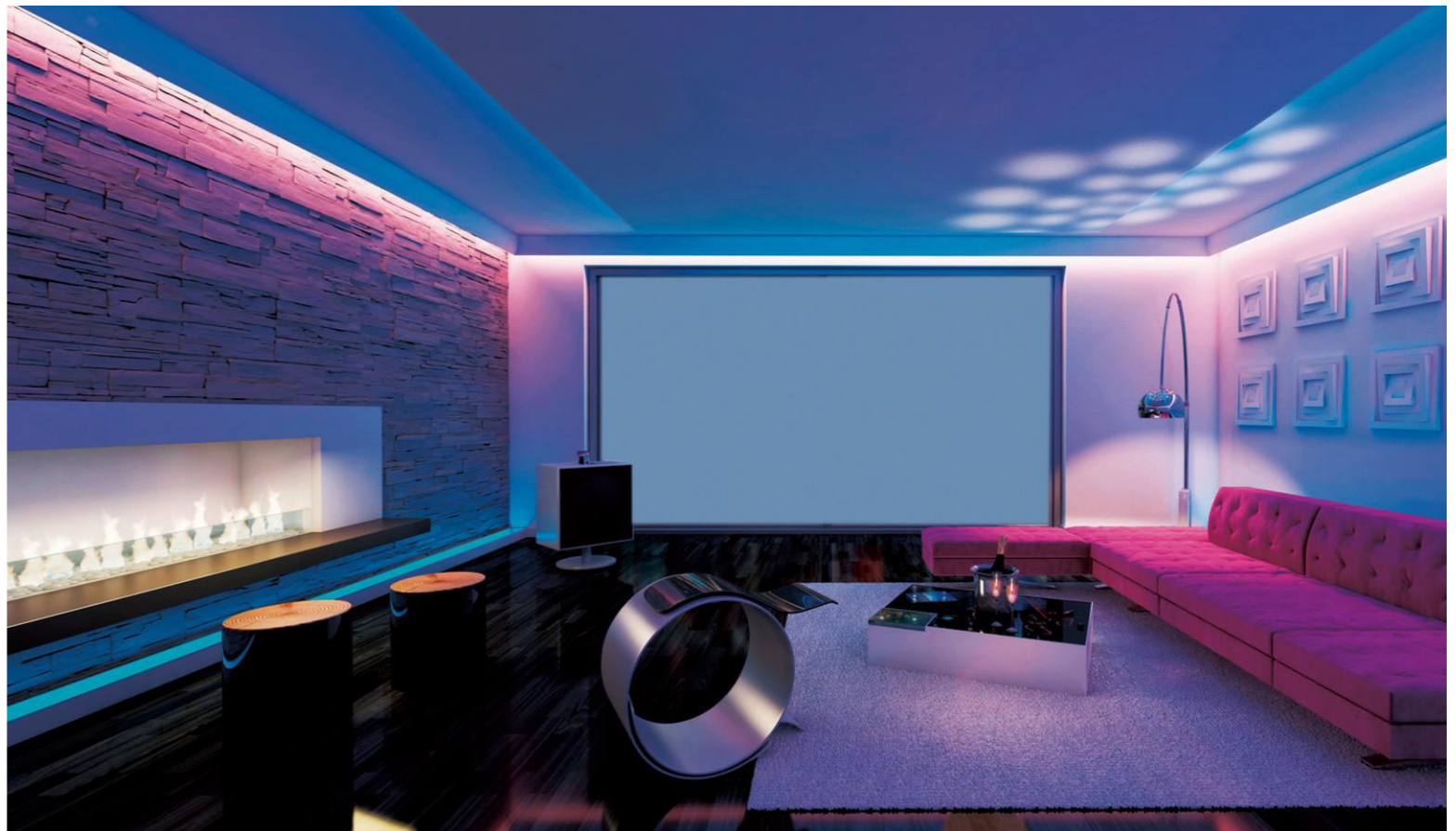

LED Strip Light

LED Strip Light Accessory

Aluminum Profile

LED Linear Luminaire

LED Panel Light

LED Panel Light Accessory

LED Strip Light

LED Strip Light Accessory

Aluminum Profile

LED Linear Luminaire

LED Panel Light

LED Panel Light Accessory

# RGB+WW/W

## Product Features

- 1. Low-voltage 24VDC and 12VDC, 100% safe.
- 2. Energy-saving, eco-friendly, anti-UV and no optical radiation.
- 3. RGB and White LEDs are operated, and 4 chips in 1 for option.
- 4. RGB+W LED Strip is much more beautiful and colorful than normal RGB LED strip.

# ES-FS3535RGBW-96-24-Y

- ①
- ②
- ③
- ④
- ⑤
- ⑥

1

**LED Type**  
 SMD3535 | SMD3528  
 SMD5050

2

**Color**  
 620-627 NM NM  
 525-530 NM NM 470-475 NM NM

3

**Color**  
 2700-6500 K K

4

**LED Qty. per meter**  
 240 | 144 | 96 | 60

5

**Input DC Voltage**  
 24VDC | 12VDC

6

**IP Index**  
 IP 20 | IP54 | IP65  
 IP67 | IP68

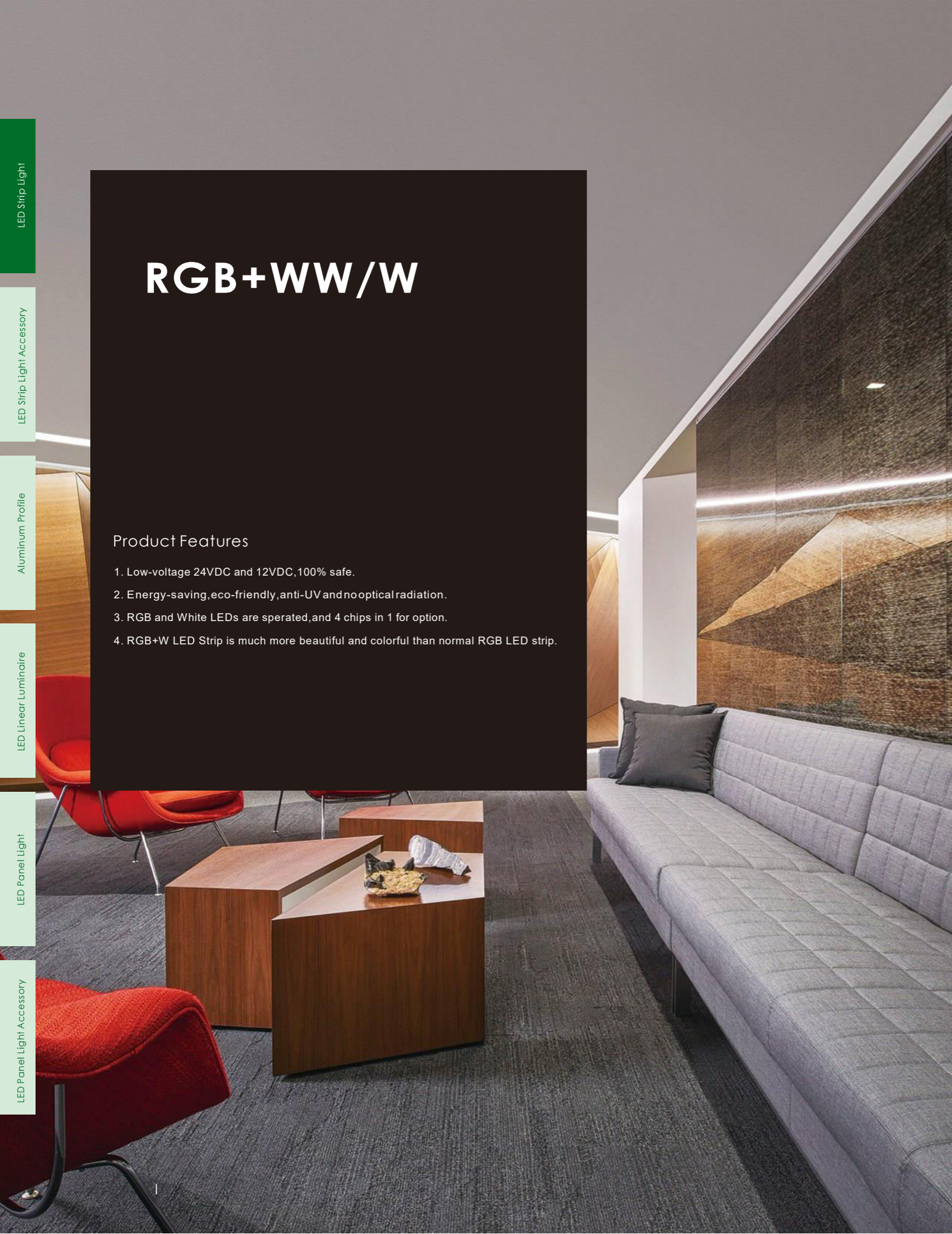

# RGBW Series

Part Number:ES-FS3535RGBW-96-24-Y

Model	Wave lengths Color temp.	LM/M	Power/M	LED/M	FPC copper
ES-FS3535RGBW-96-24-Y		1210LM	<23W	96LEDs(RGB) 96LEDs(WHITE)	3OZ

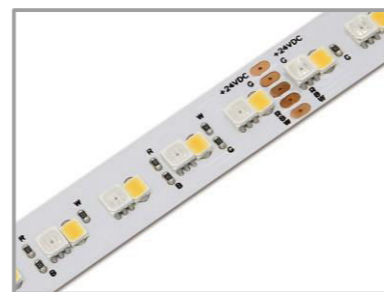

### Controller

Product No.	Description
4.02.126	5-24VDC 5A*4CH Max.20A 204W/480W(12V/24V)

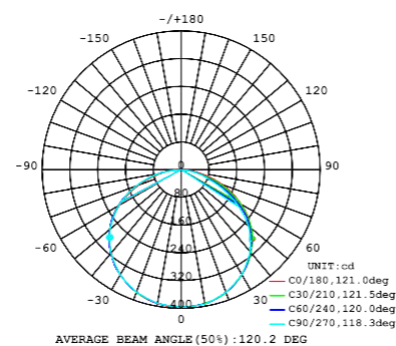

Strip length: CE:500CM UL:11.39FT

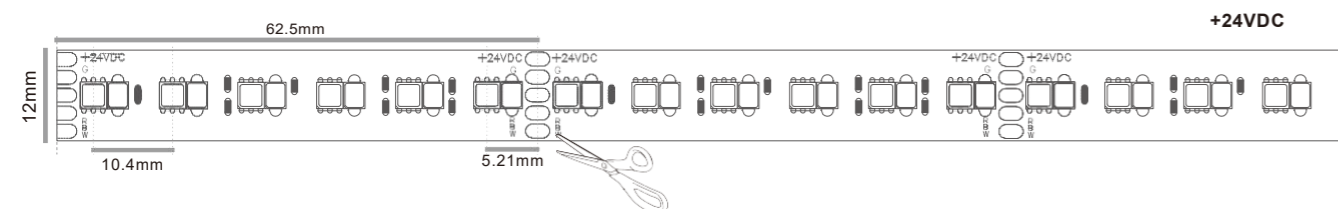

### IP Rating:

- IP20---Non waterproof
- IP54---Nano coated
- IP65---Silicon coated
- IP67---Silicon coated & Wrapped heat shrink tube
- IP67---PVC extrusion
- IP67---Silicon extrusion
- IP67---Silicon tube(transparent)
- IP68---Silicon tube(transparent) & Inject silicon glue

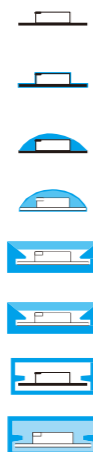

### AL. profiles (mm)

# RGBW Series

Part Number:ES-FS3528RGBW-240-24-Y

Model	Wave lengths Color temp.	LM/M	Power/M	LED/M	FPC copper
ES-FS3528RGBW-240-24-Y	620-625 NM NM 517-522 NM NM 465-470 NM NM	800LM	<19.2W	60LEDs(R) 60LEDs(G) 60LEDs(B) 60LEDs(W)	3OZ



### Controller

Product No.	Description
4.02.126	5-24VDC 5A*4CH Max.20A 204W/480W(12V/24V)

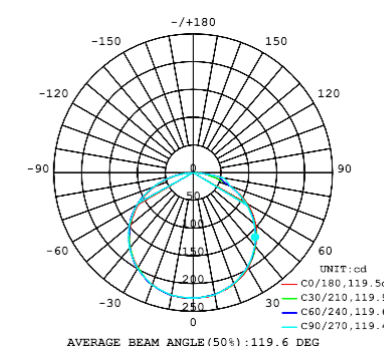

Strip length: CE:500CM UL:16.4FT

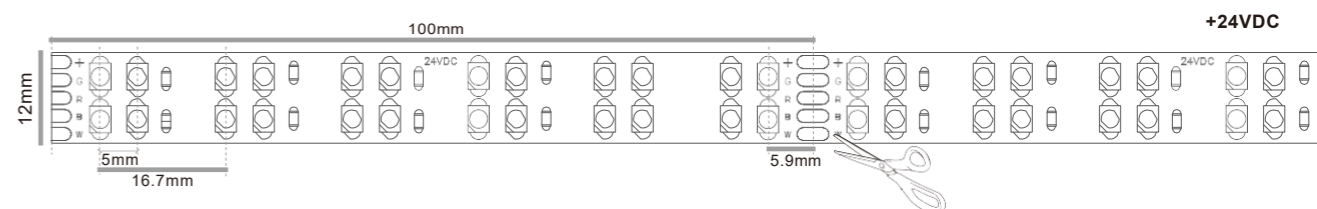

### IP Rating:

- IP20---Non waterproof
- IP54---Nano coated
- IP65---Silicon coated
- IP67---Silicon coated & Wrapped heat shrink tube
- IP67---PVC extrusion
- IP67---Silicon extrusion
- IP67---Silicon tube(transparent)
- IP68---Silicon tube(transparent) & Inject silicon glue

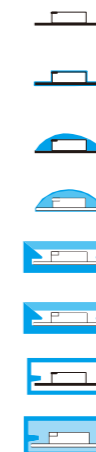

### AL. profiles (mm)



# RGBW Series

Part Number:ES-FS3528RGBW-144-12-Y

Model	Wave lengths Color temp.	LM/M	Power/M	LED/M	FPC copper
ES-FS3528RGBW-144-12-Y	620-625 NM NM	480LM	<12W	36LEDs(R) 36LEDs(G) 36LEDs(B) 36LEDs(W)	3OZ
	517-522 NM NM				
	465-470 NM NM				

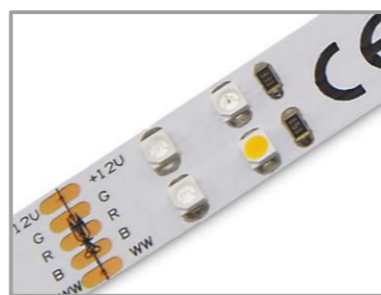

### Controller

Product No.	Description
4.02.126	5-24VDC 5A*4CH Max.20A 204W/480W(12V/24V)

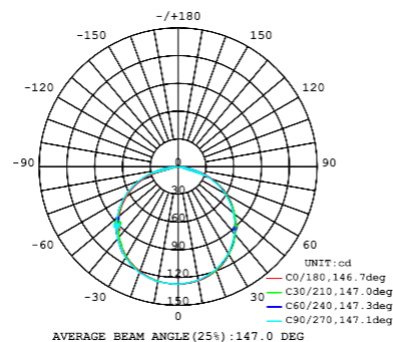

Strip length: CE:500CM

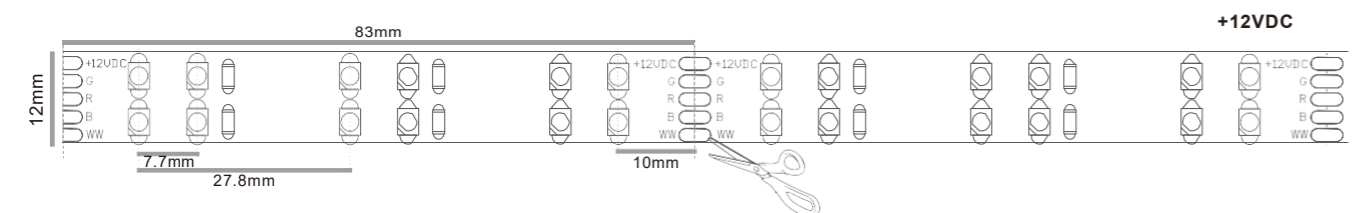

### IP Rating:

- IP20---Non waterproof
- IP54---Nano coated
- IP65---Silicon coated
- IP67---Silicon coated & Wrapped heat shrink tube
- IP67---PVC extrusion
- IP67---Silicon extrusion
- IP67---Silicon tube(transparent)
- IP68---Silicon tube(transparent) & Inject silicon glue

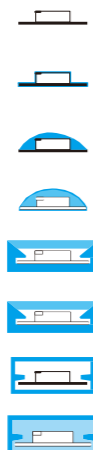

### AL. profiles (mm)

ES-LL017009	ES-LL024011	ES-LL017015	ES-LL013006
ES-LL023009	ES-LL030011	ES-LL023015	ES-LL013012
ES-LL016016	ES-LL020020-1	ES-LL025019	ES-LL025025
ES-LL030030	ES-LL010015	ES-LL025046	
ES-LL057011	ES-LL064014		

# RGBW Series

Part Number:ES-FS5050RGBW-96-24-Y

Model	Wave lengths Color temp.	LM/M	Power/M	LED/M	FPC copper
ES-FS5050RGBW-96-24-Y	620-627 NM NM	920LM	<23W	48LEDs(RGB) 48LEDs(W)	3OZ
	525-530 NM NM				
	470-475 NM NM				

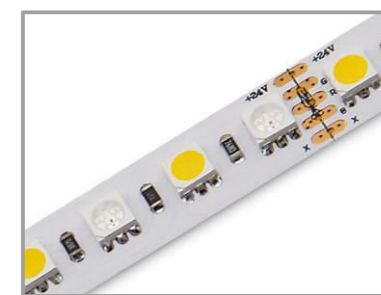

### Controller

Product No.	Description
4.02.126	5-24VDC 5A*4CH Max.20A 204W/480W(12V/24V)

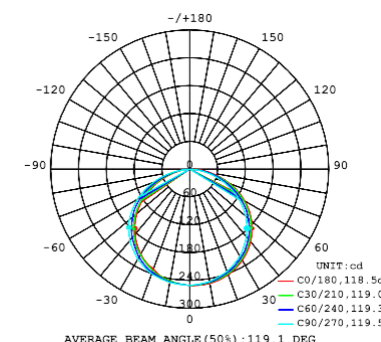

Strip length: CE:500CM UL:13.12FT

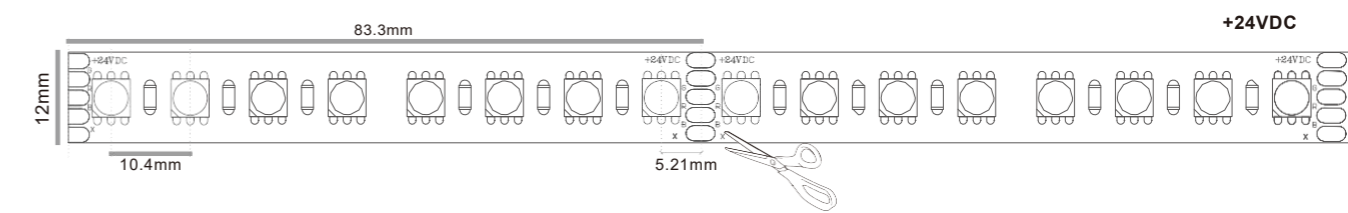

### IP Rating:

- IP20---Non waterproof
- IP54---Nano coated
- IP65---Silicon coated
- IP67---Silicon coated & Wrapped heat shrink tube
- IP67---PVC extrusion
- IP67---Silicon extrusion
- IP67---Silicon tube(transparent)
- IP68---Silicon tube(transparent) & Inject silicon glue

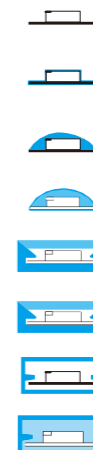

### AL. profiles (mm)

ES-LL017009	ES-LL024011	ES-LL017015	ES-LL013006
ES-LL023009	ES-LL030011	ES-LL023015	ES-LL013012
ES-LL016016	ES-LL020020-1	ES-LL025019	ES-LL025025
ES-LL030030	ES-LL010015	ES-LL025046	
ES-LL057011	ES-LL064014		

# RGBW Series

Part Number:ES-FS5050RGBW-96H-24-Y

Model	Wave lengths Color temp.	LM/M	Power/M	LED/M	FPC copper
ES-FS5050RGBW-96H-24-Y	3000K 4000K 6500K	980LM	<23W	96LEDs	3OZ



### Controller

Product No.	Description
4.02.126	5-24VDC 5A*4CH Max.20A 204W/480W(12V/24V)

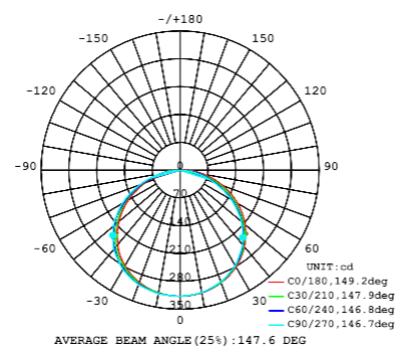

Strip length: CE:500CM UL:13.12FT

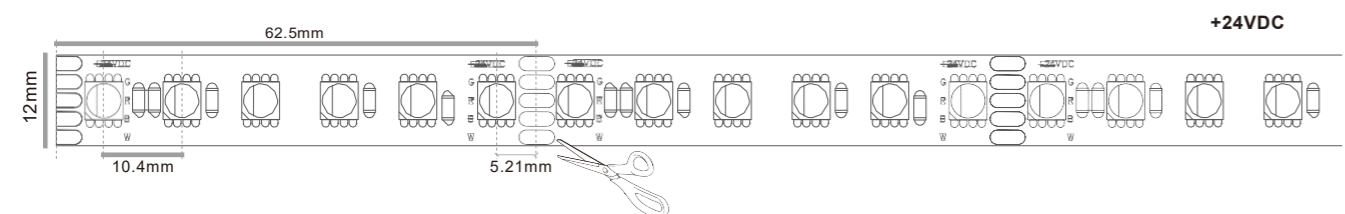

### IP Rating:

- IP20---Non waterproof
- IP54---Nano coated
- IP65---Silicon coated
- IP67---Silicon coated & Wrapped heat shrink tube
- IP67---PVC extrusion
- IP67---Silicon extrusion
- IP67---Silicon tube(transparent)
- IP68---Silicon tube(transparent) & Inject silicon glue

### AL. profiles (mm)

ES-LL017009	ES-LL024011	ES-LL017015	ES-LL013006
ES-LL023009	ES-LL030011	ES-LL023015	ES-LL013012
ES-LL016016	ES-LL020020-1	ES-LL025019	ES-LL025025
ES-LL030030	ES-LL010015	ES-LL025046	
ES-LL057011	ES-LL064014		

# RGBW Series

Part Number:ES-FS5050RGBW-60-24-Y

Part Number:ES-FS5050RGBW-60-12-Y

Model	Wave lengths Color temp.	LM/M	Power/M	LED/M	FPC copper
ES-FS5050RGBW-60-24-Y		780LM	<14.4W	60LEDs	3OZ



### Controller

Product No.	Description
4.02.126	5-24VDC 5A*4CH Max.20A 204W/480W(12V/24V)

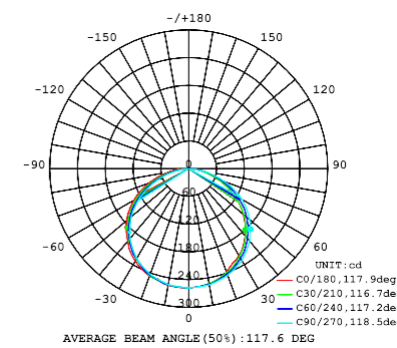

Strip length: CE:500CM UL:22.63FT(24V) | 13.12FT(12V)

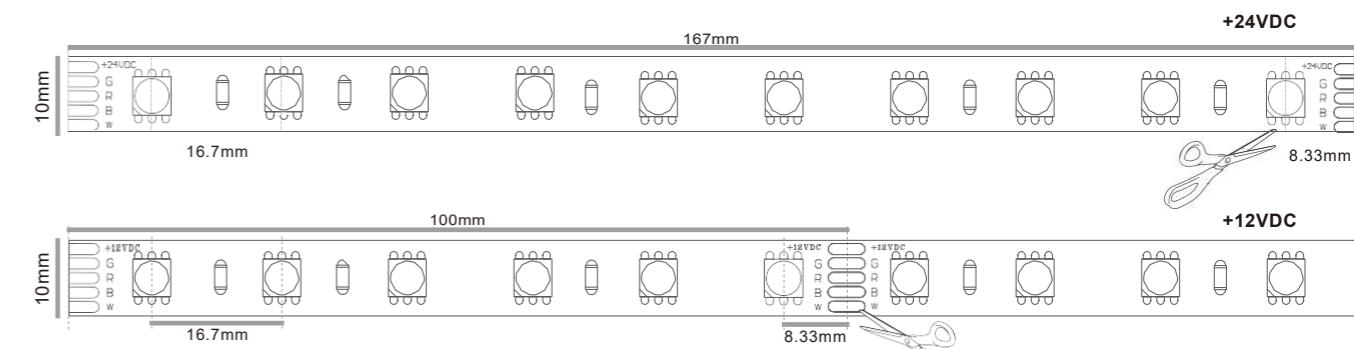

### IP Rating:

- IP20---Non waterproof
- IP54---Nano coated
- IP65---Silicon coated
- IP67---Silicon coated & Wrapped heat shrink tube
- IP67---PVC extrusion
- IP67---Silicon extrusion
- IP67---Silicon tube(transparent)
- IP68---Silicon tube(transparent) & Inject silicon glue

### AL. profiles (mm)

ES-LL017009	ES-LL024011	ES-LL017015	ES-LL013006
ES-LL023009	ES-LL030011	ES-LL023015	ES-LL013012
ES-LL016016	ES-LL020020-1	ES-LL025019	ES-LL025025
ES-LL030030	ES-LL010015	ES-LL025046	
ES-LL057011	ES-LL064014		

# RGBW Series

Part Number: ES-FS5050RGBW-60H-24-Y

Model	Wave lengths Color temp.	LM/M	Power/M	LED/M	FPC copper
ES-FS5050RGBW-60H-24-Y	<div style="background-color: #0000FF; width: 15px; height: 15px; display: inline-block;"></div> 3000K 4000K 6500K	660LM	<14.4W	60LEDs	3OZ



### Controller

Product No.	Description
4.02.126	5-24VDC 5A*4CH Max.20A 204W/480W(12V/24V)

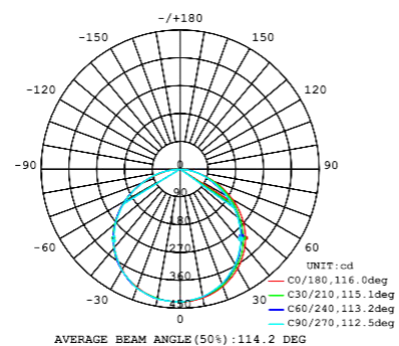

Strip length: CE:500CM UL:22.63FT

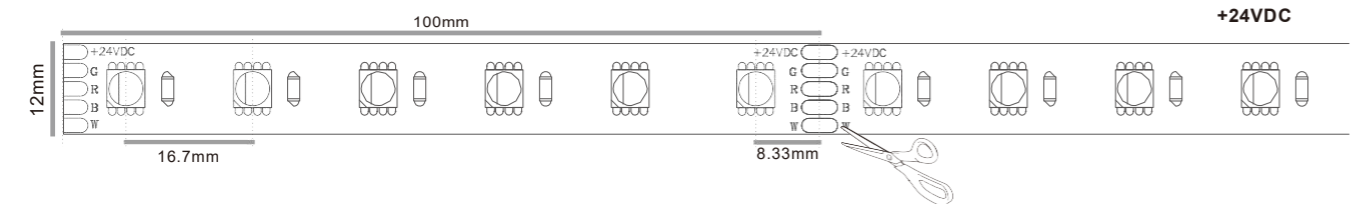

### IP Rating:

- IP20---Non waterproof
- IP54---Nano coated
- IP65---Silicon coated
- IP67---Silicon coated & Wrapped heat shrink tube
- IP67---PVC extrusion
- IP67---Silicon extrusion
- IP67---Silicon tube(transparent)
- IP68---Silicon tube(transparent) & Inject silicon glue

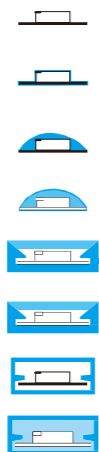

### AL. profiles (mm)

ES-LL017009	ES-LL024011	ES-LL017015	ES-LL013006
ES-LL023009	ES-LL030011	ES-LL023015	ES-LL013012
ES-LL016016	ES-LL020020-1	ES-LL025019	ES-LL025025
ES-LL030030	ES-LL010015	ES-LL025046	
ES-LL057011	ES-LL064014		



# RGBW Series

Part Number: ES-FS5050RGBW-60H-24-Y

Model	Wave lengths Color temp.	LM/M	Power/M	LED/M	FPC copper
ES-FS5050RGBW-60H-24-Y	3000K 4000K 6500K	660LM	<14.4W	60LEDs	30Z



### Controller

Product No.	Description
4.02.126	5-24VDC 5A*4CH Max.20A 204W/480W(12V/24V)

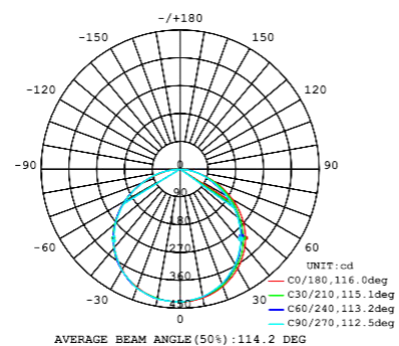

Strip length: CE:500CM UL:22.63FT

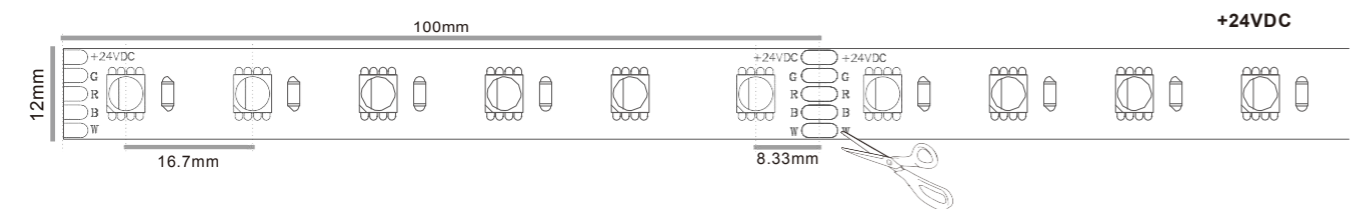

### IP Rating:

- IP20---Non waterproof
- IP54---Nano coated
- IP65---Silicon coated
- IP67---Silicon coated & Wrapped heat shrink tube
- IP67---PVC extrusion
- IP67---Silicon extrusion
- IP67---Silicon tube(transparent)
- IP68---Silicon tube(transparent) & Inject silicon glue

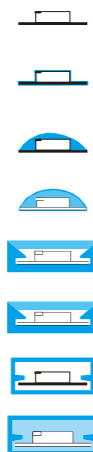

### AL. profiles (mm)

ES-LL017009	ES-LL024011	ES-LL017015	ES-LL013006
ES-LL023009	ES-LL030011	ES-LL023015	ES-LL013012
ES-LL016016	ES-LL020020-1	ES-LL025019	ES-LL025025
ES-LL030030	ES-LL010015	ES-LL025046	
ES-LL057011	ES-LL064014		

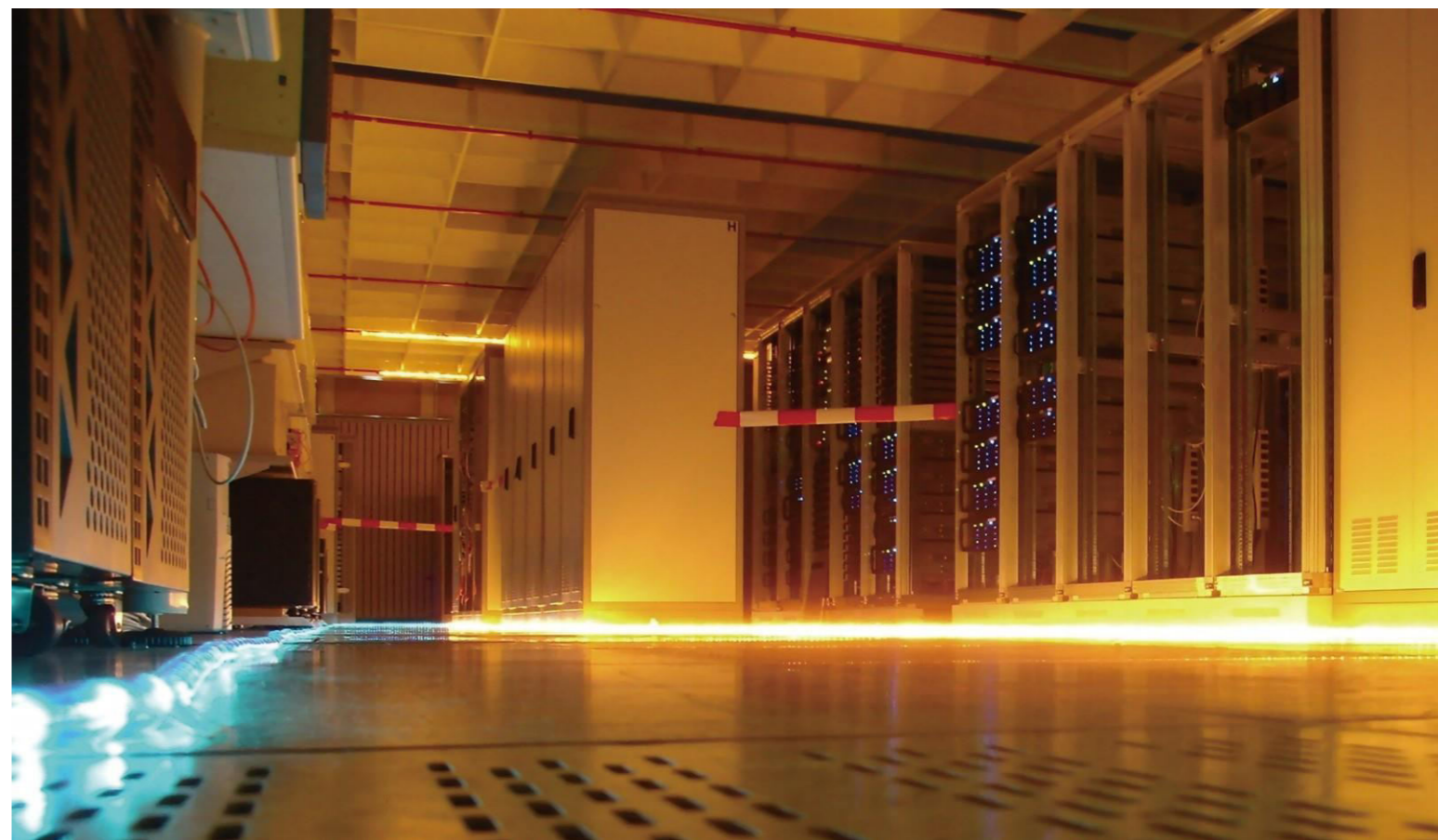

**MULTICOLOR**



# ES-FS3535RGBWW-96-24-Y

① ② ③ ④ ⑤ ⑥ ⑦

## RGB+W+WW

### Product Features

1. Low-voltage 24VDC.
2. RGB color changing and CCT adjustable in one LED strip.
3. RGB+W+WW:seperated LEDs and RGB+W+WW:5 chips in 1 for option.



### LED Type

SMD3535 |SMD5050

### Color

620-627  
NM NM

525-530  
NM NM

470-475  
NM NM

### Color

1800 K	2100 K	2300 K	2700 K	3000 K
	3500 K	4000 K	5000 K	6500 K

### Tunable CCT

2700-6500  
K K

### LED Qty.per meter

96 | 60

### Input DC Voltage

24VDC

### IP Index

IP 20 | IP54 | IP65



# RGBWW Series

Part Number:ES-FS3535RGBWW-96-24-Y

Model	Wave lengths Color temp.	LM/M	Power/M	LED/M	FPC copper
ES-FS3535RGBWW-96-24-Y		1100LM	<23W	96LEDs(RGB) 96LEDs(WHITE) 96LEDs(WARM WHITE)	3OZ

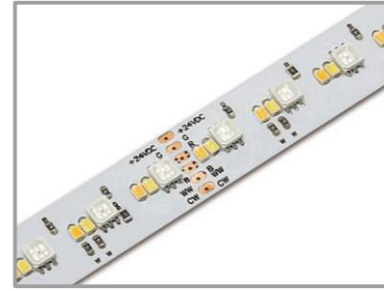

### Controller

Product No.	Description
4.02.123	12-24VDC 3A*5CH Max.15A 5CH*(36-72)W

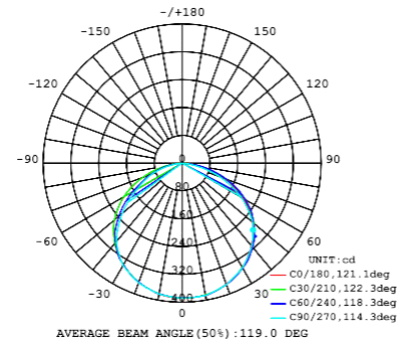

Strip length: CE:500CM UL:13.12FT

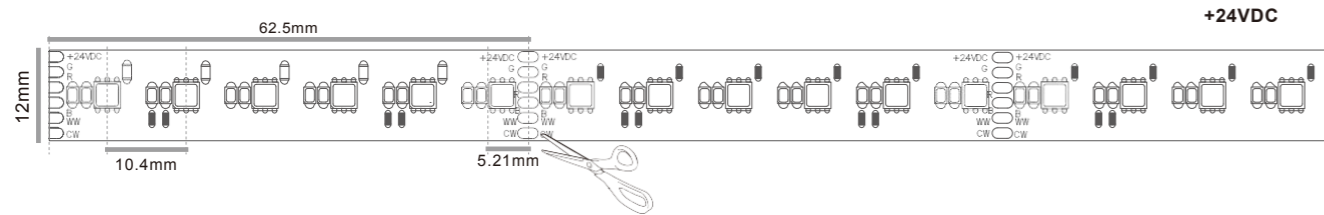

### IP Rating:

- IP20---Non waterproof
- IP54---Nano coated
- IP65---Silicon coated
- IP67---Silicon coated & Wrapped heat shrink tube
- IP67---PVC extrusion
- IP67---Silicon extrusion
- IP67---Silicon tube(transparent)
- IP68---Silicon tube(transparent) & Inject silicon glue

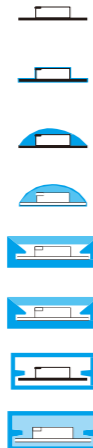

### AL. profiles (mm)

# RGBWW Series

Part Number:ES-FS5050RGBWW-96-24-Y

Model	Wave lengths Color temp.	LM/M	Power/M	LED/M	FPC copper
ES-FS5050RGBWW-96-24-Y		1450LM	<23W	96LEDs	3OZ

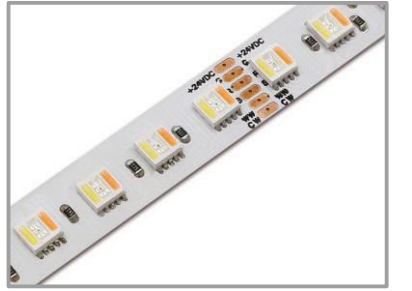

### Controller

Product No.	Description
4.02.123	12-24VDC 3A*5CH Max.15A 5CH*(36-72)W

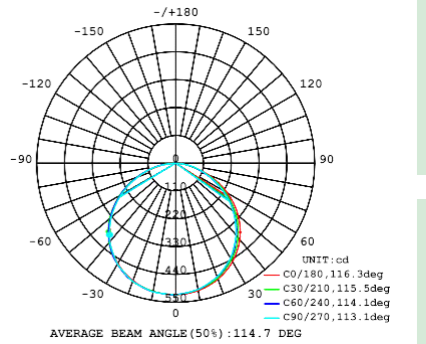

Strip length: CE:500CM UL:13.12FT

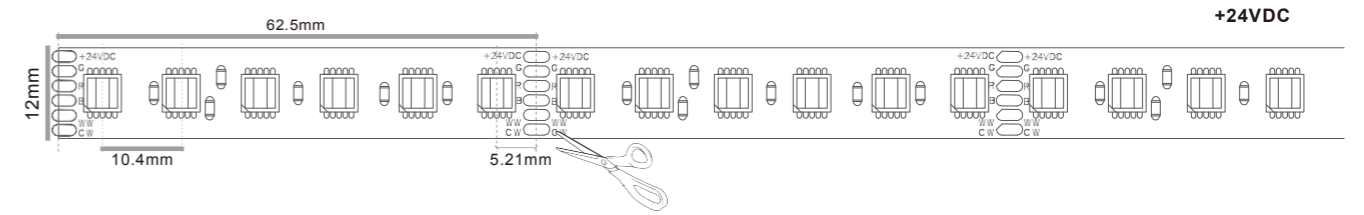

### IP Rating:

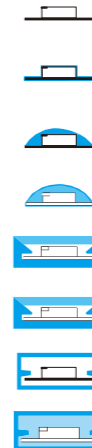

- IP20---Non waterproof
- IP54---Nano coated
- IP65---Silicon coated
- IP67---Silicon coated & Wrapped heat shrink tube
- IP67---PVC extrusion
- IP67---Silicon extrusion
- IP67---Silicon tube(transparent)
- IP68---Silicon tube(transparent) & Inject silicon glue



### AL. profiles (mm)

# RGBWW Series

Part Number: ES-FS5050RGBWW-60-24-Y

Model	Wave lengths Color temp.	LM/M	Power/M	LED/M	FPC copper
ES-FS5050RGBWW-60-24-Y		1300LM	<23W	60LEDs	3OZ
					
					

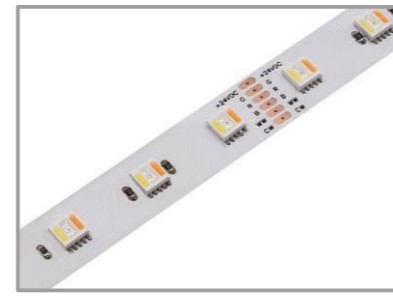

**Controller**



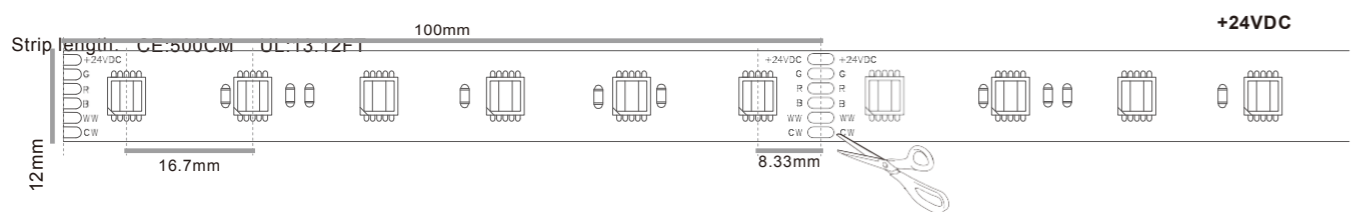
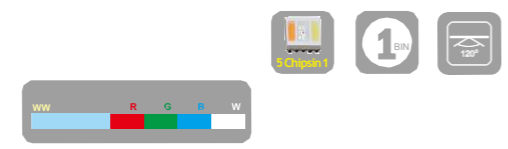
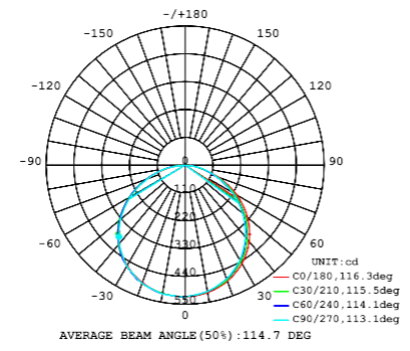





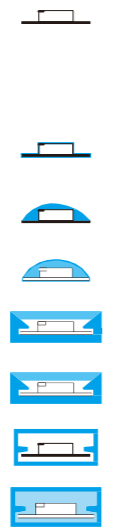





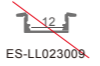

Product No.	Description
4.02.123	12-24VDC 3A*5CH Max.15A 5CH*(36-72)W

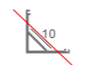

AL. profiles (mm)

- IP Rating:**
- IP20---Non waterproof
  - IP54---Nano coated
  - IP65---Silicon coated
  - IP67---Silicon coated & Wrapped heat shrink tube
  - IP67---PVC extrusion
  - IP67---Silicon extrusion
  - IP67---Silicon tube(transparent)
  - IP68---Silicon tube(transparent) & Inject silicon glue

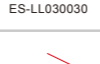

 ES-LL017009	 ES-LL024011	 ES-LL017015	 ES-LL013006
 ES-LL023009	 ES-LL030011	 ES-LL023015	 ES-LL013012
 ES-LL016016	 ES-LL020020-1	 ES-LL025019	 ES-LL025025
 ES-LL030030	 ES-LL010015	 ES-LL025046	
 ES-LL057011	 ES-LL064014		

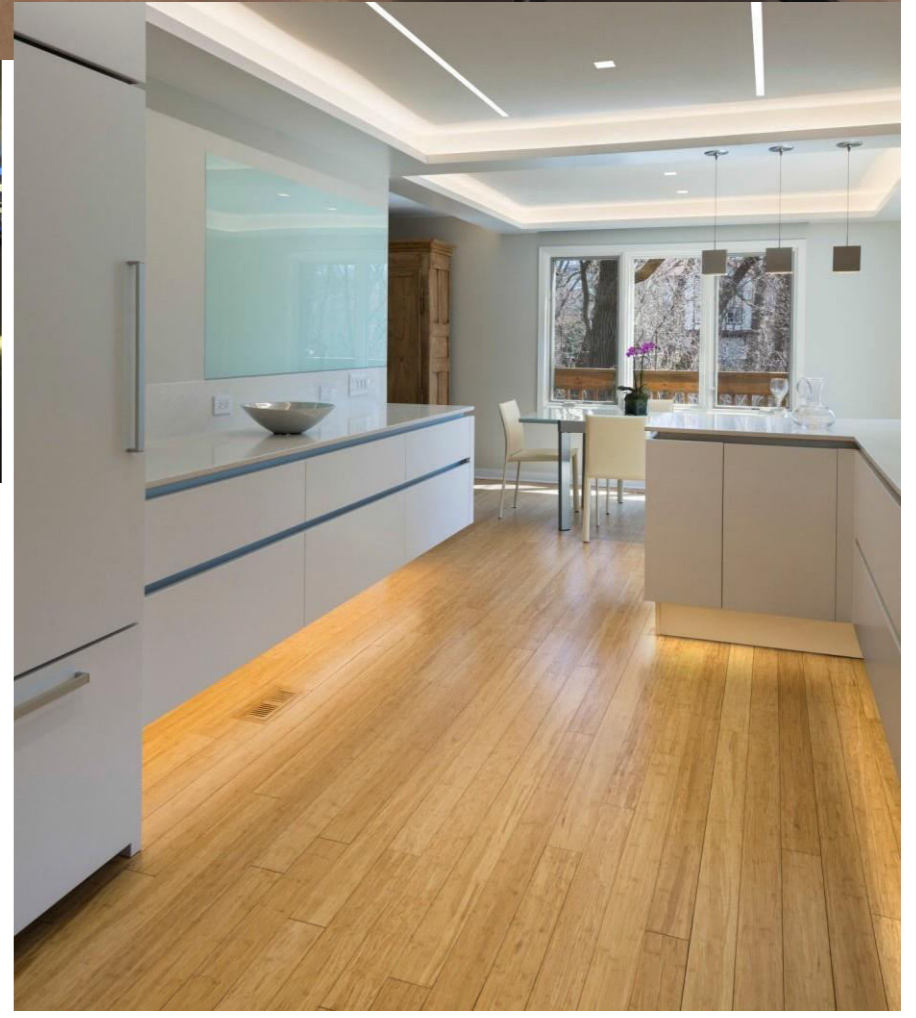
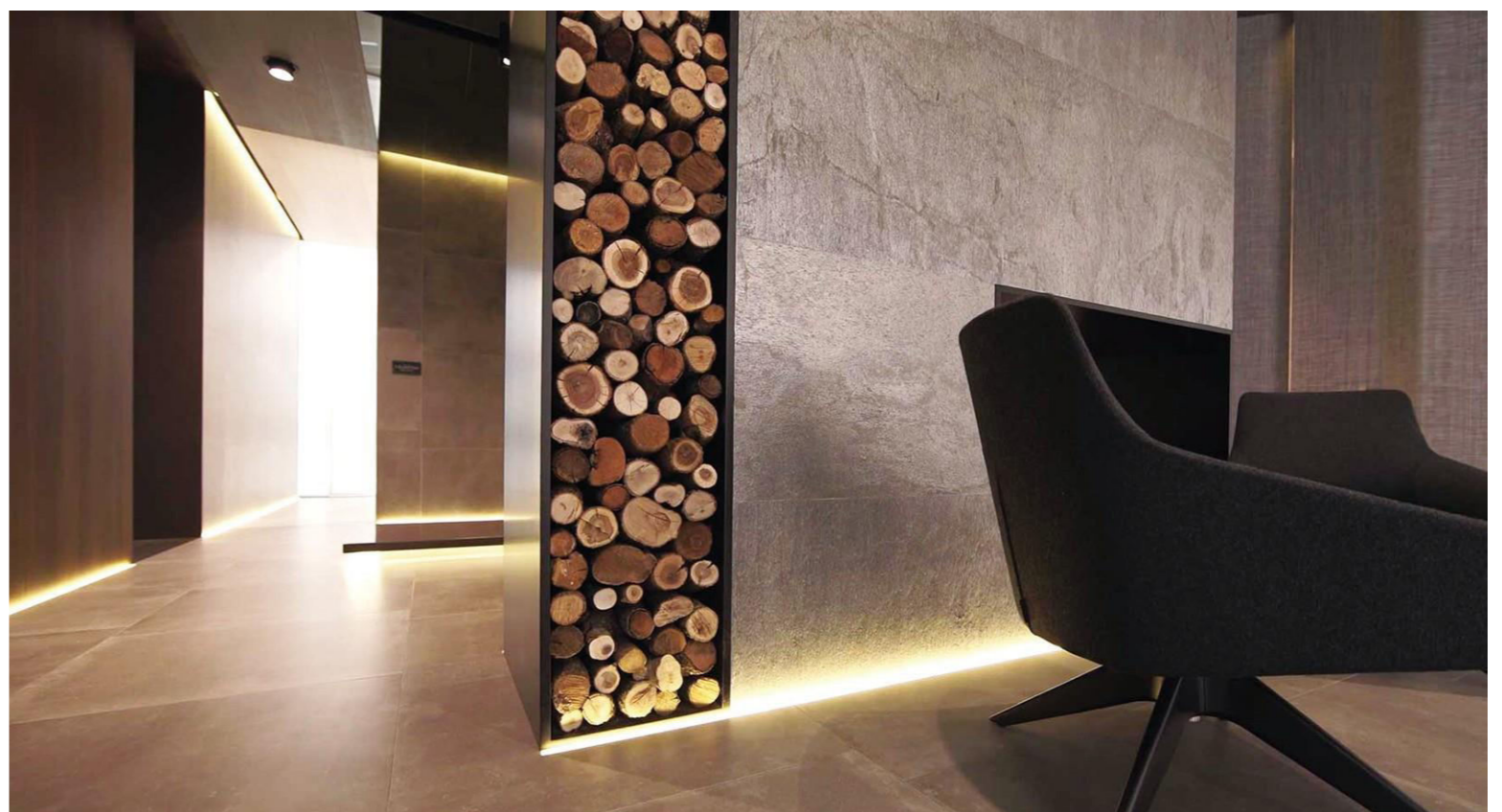

LED Strip Light

LED Strip Light Accessory

Aluminum Profile

LED Linear Luminaire

LED Panel Light

LED Panel Light Accessory

LED Strip Light

LED Strip Light Accessory

Aluminum Profile

LED Linear Luminaire

LED Panel Light

LED Panel Light Accessory



# WW+W

## Product Features

1. Energy-saving, eco-friendly, anti-UV and no optical radiation.
2. Warm white and white LEDs are separated, and 2 chips in 1 for option.
3. High density LED per meter, excellent performance on ww+w color changing.
4. Common application for light font.

# ES-FS2835WW+W-120-24-Y

①

②

③

④

⑤

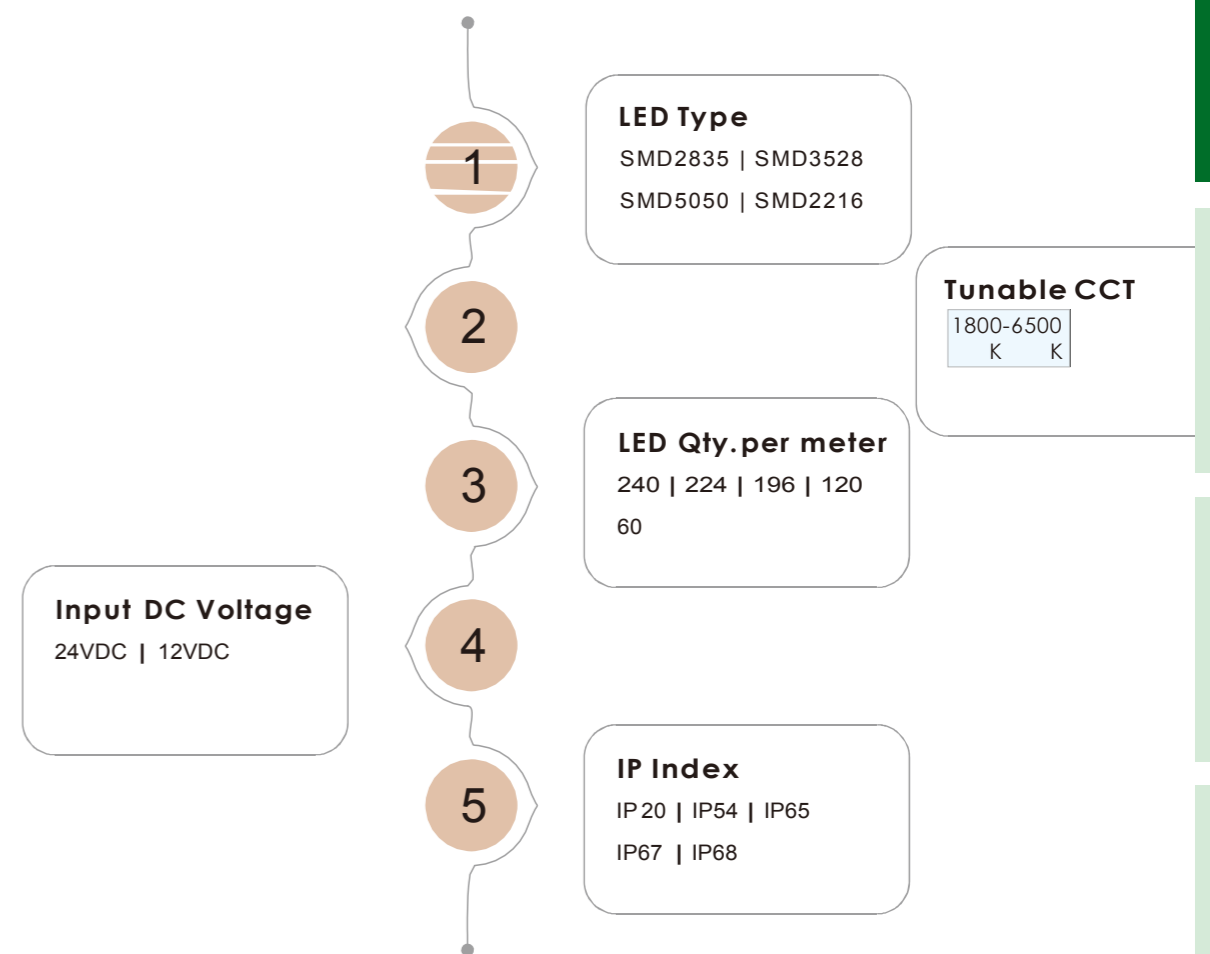

# WW+W Series

Part Number: ES-FS2835WW+W-120-24-Y

Model	Tunable CCT	LM/M	Power/M	FPC copper
ES-FS2835WW+W-120-24-Y	1800-6500 K K	1650LM	<23W	3OZ



### Controller

Product No.	Description
4.02.128	12-24VDC 3A*2CH Max.6A 72W/144W(12V/24V)

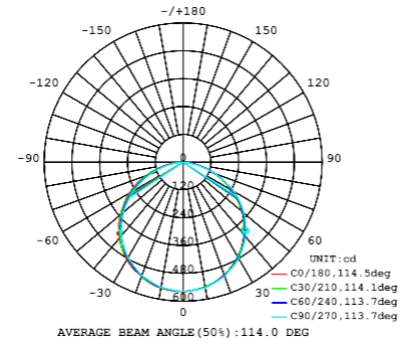

Strip length: CE:500CM UL:13.12FT

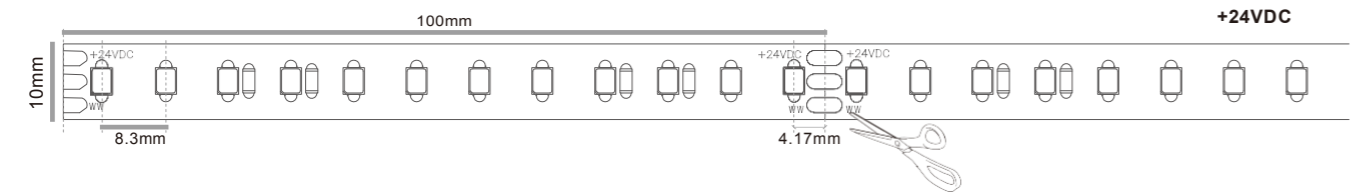

### IP Rating:

- IP20---Non waterproof
- IP54---Nano coated
- IP65---Silicon coated
- IP67---Silicon coated & Wrapped heat shrink tube
- IP67---PVC extrusion
- IP67---Silicon extrusion
- IP67---Silicon tube(transparent)
- IP68---Silicon tube(transparent) & Inject silicon glue

### AL. profiles (mm)

# WW+W Series

Part Number: ES-FS3528WW+W-240H-24-Y

Model	Tunable CCT	LM/M	Power/M	FPC copper
ES-FS3528WW+W-240H-24-Y	2700-6500 K K	1400LM	<19.2W	3OZ



### Controller

Product No.	Description
4.02.128	12-24VDC 3A*2CH Max.6A 72W/144W(12V/24V)

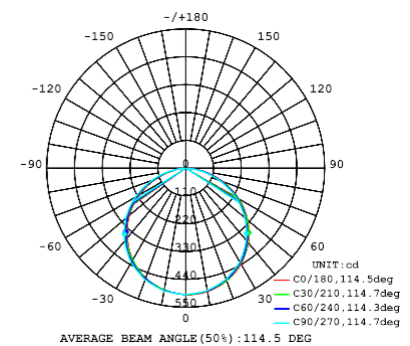

Strip length: CE:500CM UL:16.4FT

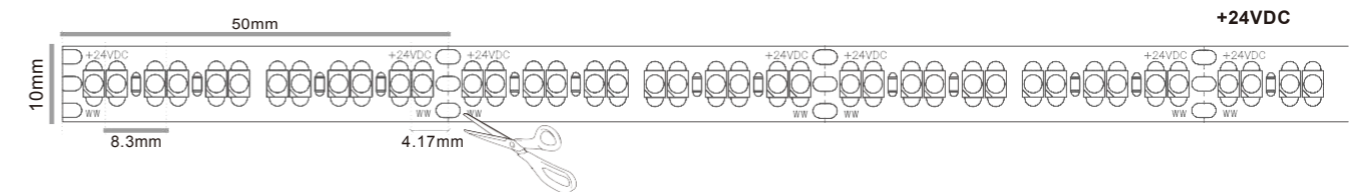

### IP Rating:

- IP20---Non waterproof
- IP54---Nano coated
- IP65---Silicon coated
- IP67---Silicon coated & Wrapped heat shrink tube
- IP67---PVC extrusion
- IP67---Silicon extrusion
- IP67---Silicon tube(transparent)
- IP68---Silicon tube(transparent) & Inject silicon glue

### AL. profiles (mm)

# WW+W Series

Part Number:ES-FS3528WW+W-240-24-Y  
 Part Number:ES-FS3528WW+W-240-12-Y

Model	Tunable CCT	LM/M	Power/M	FPC copper
ES-FS3528WW+W-240-24-Y	2700-6500 K K	1400LM	<19.2W	3OZ



### Controller

Product No.	Description
4.02.128	12-24VDC 3A*2CH Max.6A 72W/144W(12V/24V)

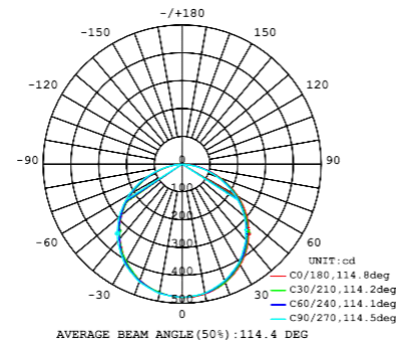

Strip length: CE:500CM UL:16.4FT(24V) | 9.85FT(12V)

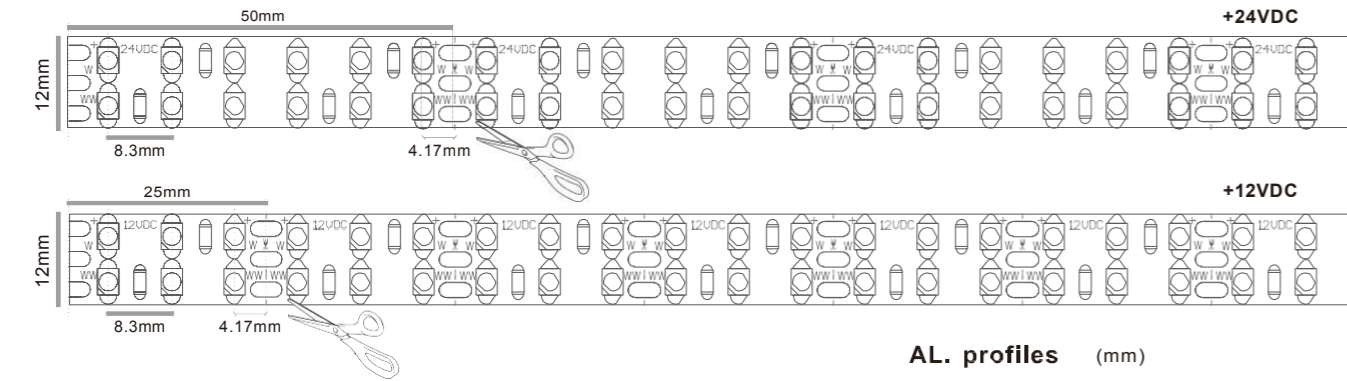

### IP Rating:

- IP20---Non waterproof
- IP54---Nano coated
- IP65---Silicon coated
- IP67---Silicon coated & Wrapped heat shrink tube
- IP67---PVC extrusion
- IP67---Silicon extrusion
- IP67---Silicon tube(transparent)
- IP68---Silicon tube(transparent) & Inject silicon glue

### AL. profiles (mm)

# WW+W Series

Part Number:ES-FS3528WW+W-120-24-Y

Model	Tunable CCT	LM/M	Power/M	FPC copper
ES-FS3528WW+W-120-24-Y	2700-6500 K K	700LM	<9.6W	3OZ

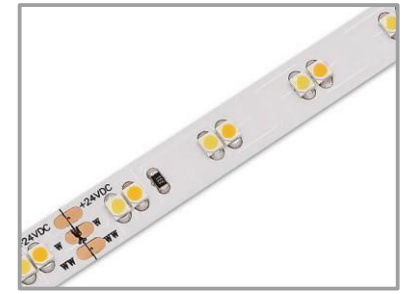

### Controller

Product No.	Description
4.02.128	12-24VDC 3A*2CH Max.6A 72W/144W(12V/24V)

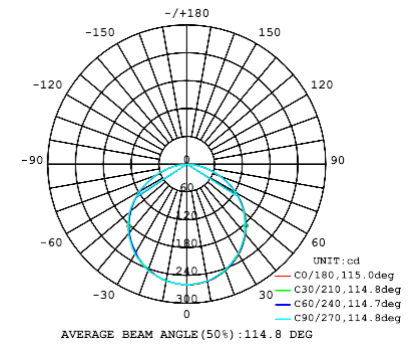

Strip length: CE:500CM UL:32.8FT

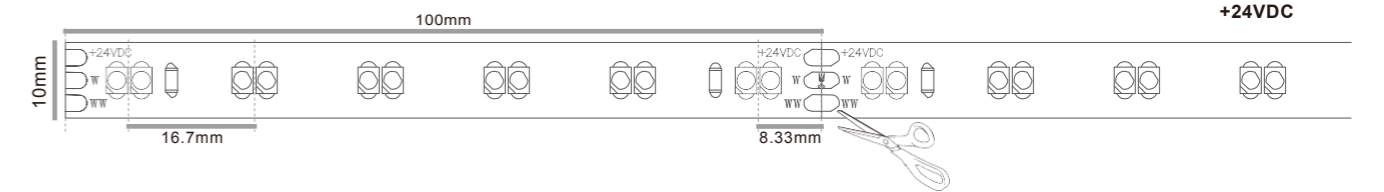

### IP Rating:

- IP20---Non waterproof
- IP54---Nano coated
- IP65---Silicon coated
- IP67---Silicon coated & Wrapped heat shrink tube
- IP67---PVC extrusion
- IP67---Silicon extrusion
- IP67---Silicon tube(transparent)
- IP68---Silicon tube(transparent) & Inject silicon glue

### AL. profiles (mm)

# WW+W Series

Part Number:ES-FS3528WW+W-120H-24-Y  
 Part Number:ES-FS3528WW+W-120H-12-Y

Model	Tunable CCT	LM/M	Power/M	FPC copper
ES-FS3528WW+W-120H-24-Y	2700-6500 K K	1600LM	<19.2W	3OZ
ES-FS3528WW+W-120H-12-Y	2700-6500 K K	1400LM	<17.0W	3OZ

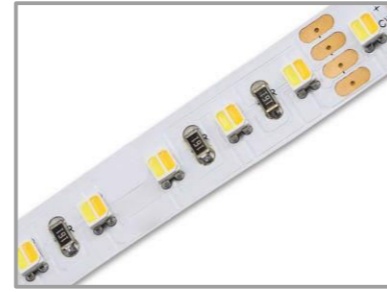

### Controller

Product No.	Description
4.02.128	12-24VDC 3A*2CH Max.6A 72W/144W(12V/24V)

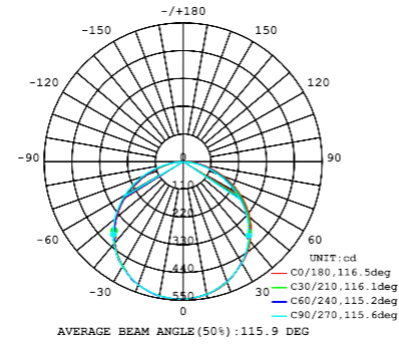

Strip length: CE:500CM UL:32.8FT(24V) | 11.48FT(12V)

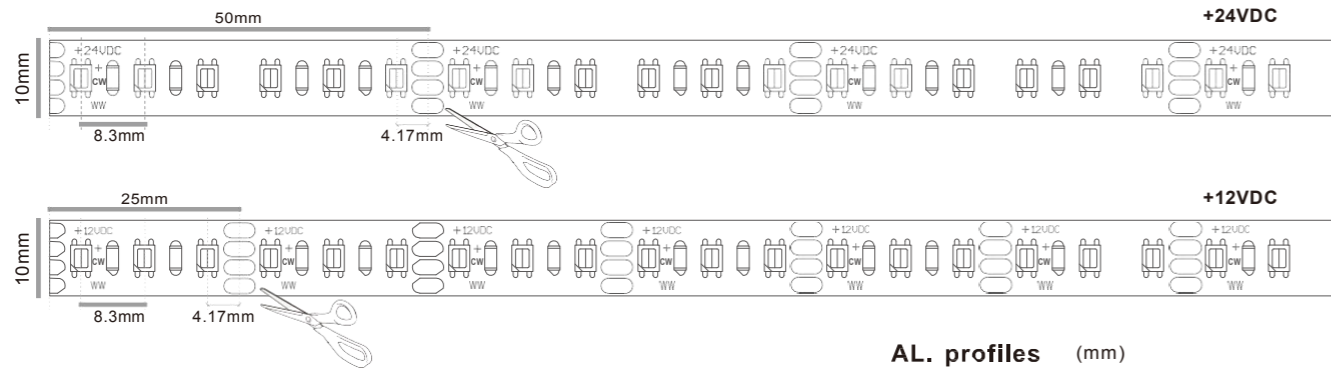

### IP Rating:

- IP20---Non waterproof
- IP54---Nano coated
- IP65---Silicon coated
- IP67---Silicon coated & Wrapped heat shrink tube
- IP67---PVC extrusion
- IP67---Silicon extrusion
- IP67---Silicon tube(transparent)
- IP68---Silicon tube(transparent) & Inject silicon glue

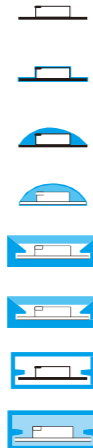

### AL. profiles (mm)

ES-LL017009	ES-LL024011	ES-LL017015	ES-LL013006
ES-LL023009	ES-LL030011	ES-LL023015	ES-LL013012
ES-LL016016	ES-LL020020-1	ES-LL025019	ES-LL025025
ES-LL030030	ES-LL010015	ES-LL025046	
ES-LL057011	ES-LL064014		

# WW+W Series

Part Number:ES-FS5050WW+W-60-24-Y  
 Part Number:ES-FS5050WW+W-60-12-Y

Model	Tunable CCT	LM/M	Power/M	FPC copper
ES-FS5050WW+W-60-24-Y	2700-6500 K K	1060LM	<14.4W	3OZ
ES-FS5050WW+W-60-12-Y	2700-6500 K K	1060LM	<14.4W	3OZ



### Controller

Product No.	Description
4.02.128	12-24VDC 3A*2CH Max.6A 72W/144W(12V/24V)

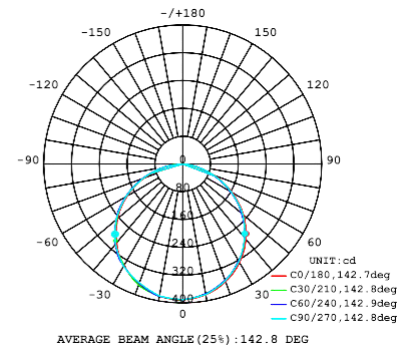

Strip length: CE:500CM UL:22.97FT(24V) | 13.12FT(12V)

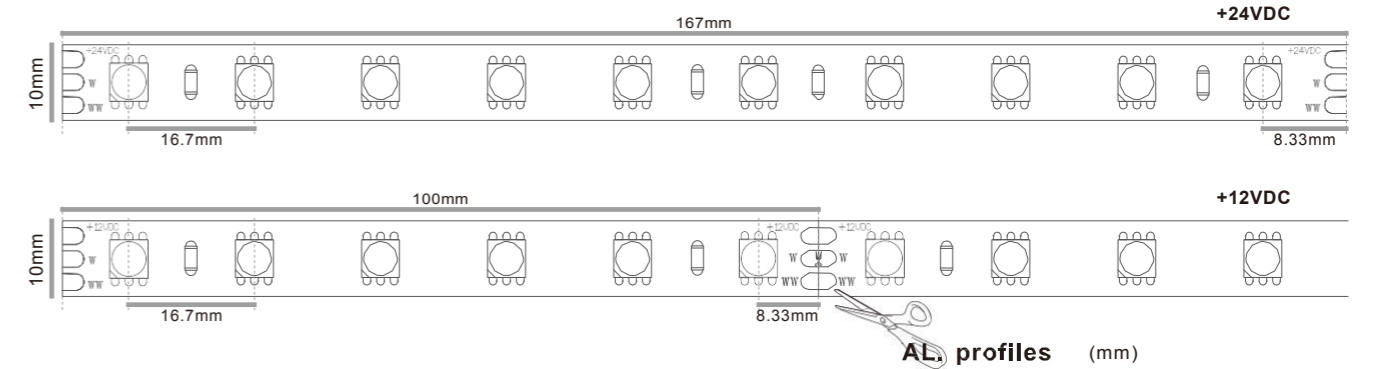

### IP Rating:

- IP20---Non waterproof
- IP54---Nano coated
- IP65---Silicon coated
- IP67---Silicon coated & Wrapped heat shrink tube
- IP67---PVC extrusion
- IP67---Silicon extrusion
- IP67---Silicon tube(transparent)
- IP68---Silicon tube(transparent) & Inject silicon glue

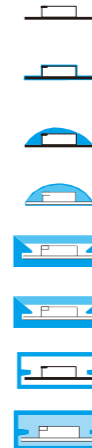

### AL. profiles (mm)

ES-LL017009	ES-LL024011	ES-LL017015	ES-LL013006
ES-LL023009	ES-LL030011	ES-LL023015	ES-LL013012
ES-LL016016	ES-LL020020-1	ES-LL025019	ES-LL025025
ES-LL030030	ES-LL010015	ES-LL025046	
ES-LL057011	ES-LL064014		

# WW+W Series

Part Number:ES-FS5050WW+W-60H-24-Y  
 Part Number:ES-FS5050WW+W-60H-12-Y

Model	Tunable CCT	LM/M	Power/M	FPC copper
ES-FS5050WW+W-60H-24-Y	2700-6500 K K	920LM	<14.4W	3OZ
ES-FS5050WW+W-60H-12-Y	2700-6500 K K	920LM	<14.4W	3OZ

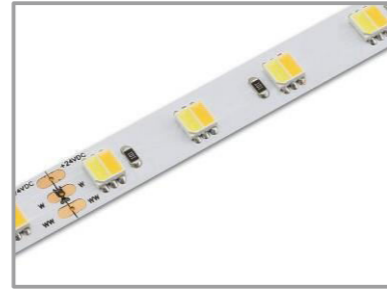

### Controller

Product No.	Description
4.02.128	12-24VDC 3A*2CH Max.6A 72W/144W(12V/24V)

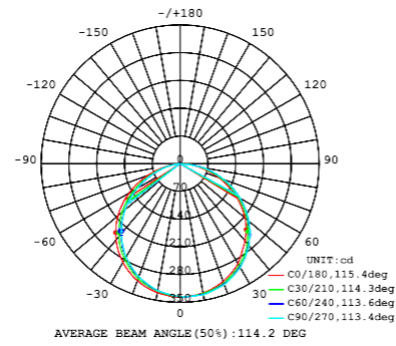

Strip length: CE:500CM UL:22.97FT(24V) | 13.12FT(12V)

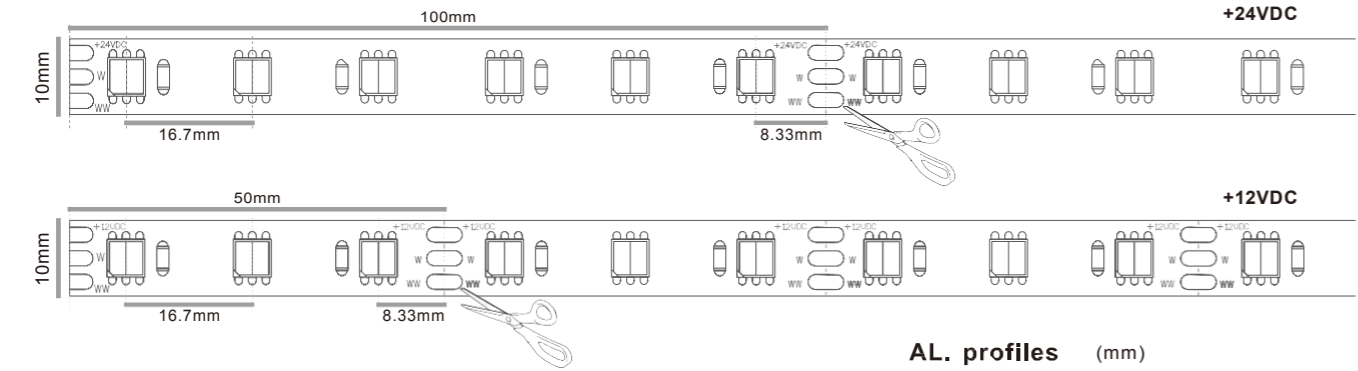

### IP Rating:

- IP20---Non waterproof
- IP54---Nano coated
- IP65---Silicon coated
- IP67---Silicon coated & Wrapped heat shrink tube
- IP67---PVC extrusion
- IP67---Silicon extrusion
- IP67---Silicon tube(transparent)
- IP68---Silicon tube(transparent) & Inject silicon glue



### AL. profiles (mm)

ES-LL017009	ES-LL024011	ES-LL017015	ES-LL013006
ES-LL023009	ES-LL030011	ES-LL023015	ES-LL013012
ES-LL016016	ES-LL020020-1	ES-LL025019	ES-LL025025
ES-LL030030	ES-LL010015	ES-LL025046	
ES-LL057011	ES-LL064014		

# WW+W Series

Part Number:ES-FS2216WW+NW+PW-252-24-Y

Model	3 Tunable CCT	LM/M	Power/M	FPC copper
ES-FS2216WW+NW+PW-252-24-Y	1800-6500 K K K	1400LM	<19.2W	3OZ

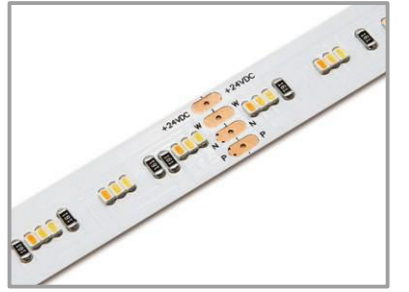

### Controller

Product No.	Description
4.02.127	12-24VDC 3A*3CH Max.9A 108W/216W(12V/24V)

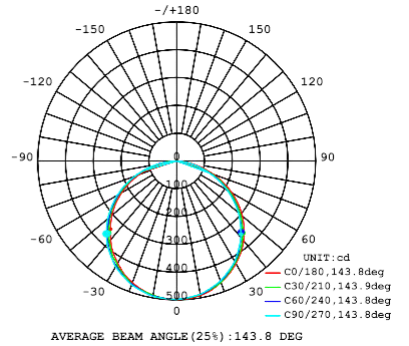

Strip length: CE:500CM UL:17FT

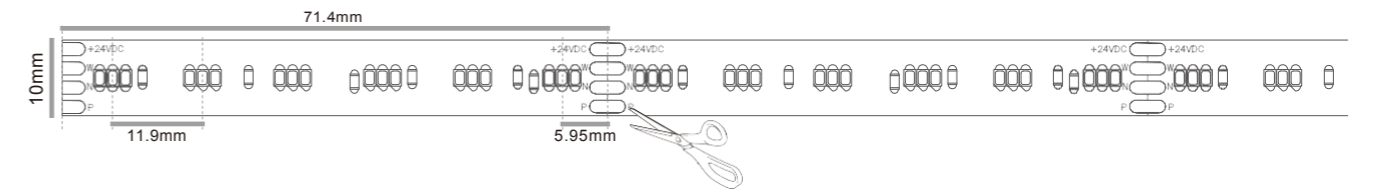

### IP Rating:

- IP20---Non waterproof
- IP54---Nano coated
- IP65---Silicon coated
- IP67---Silicon coated & Wrapped heat shrink tube
- IP67---PVC extrusion
- IP67---Silicon extrusion
- IP67---Silicon tube(transparent)
- IP68---Silicon tube(transparent) & Inject silicon glue

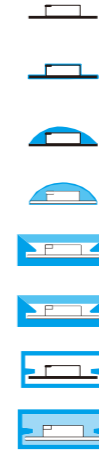

### AL. profiles (mm)

ES-LL017009	ES-LL024011	ES-LL017015	ES-LL013006
ES-LL023009	ES-LL030011	ES-LL023015	ES-LL013012
ES-LL016016	ES-LL020020-1	ES-LL025019	ES-LL025025
ES-LL030030	ES-LL010015	ES-LL025046	
ES-LL057011	ES-LL064014		

# WW+W Series

Part Number: ES-FS2216WW+W-240-24-Y

Model	Tunable CCT	LM/M	Power/M	FPC copper
ES-FS2216WW+W-240-24-Y	(Dimmer to warm)	550LM	<14.4W	3OZ



### Controller

Product No.	Description
4.02.125-1	Dimmer (PWM) 5VDC/12VDC/24VDC optional 5V<40W/12V<96W/24V<192W 6A*1CH

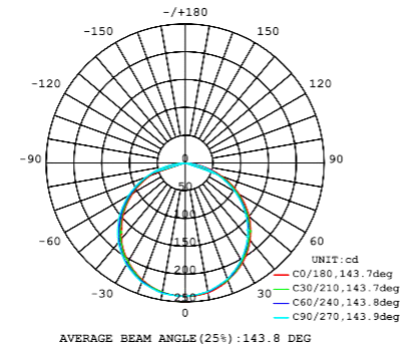

Strip length: CE:500CM UL:16.4FT

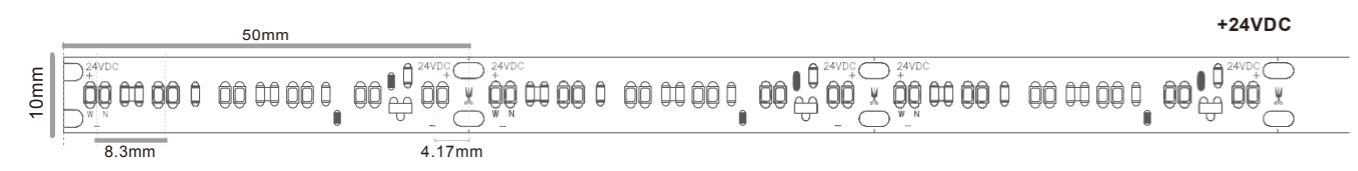

### IP Rating:

- IP20---Non waterproof
- IP54---Nano coated
- IP65---Silicon coated
- IP67---Silicon coated & Wrapped heat shrink tube
- IP67---PVC extrusion
- IP67---Silicon extrusion
- IP67---Silicon tube(transparent)
- IP68---Silicon tube(transparent) & Inject silicon glue

### AL. profiles (mm)

ES-LL017009	ES-LL024011	ES-LL017015	ES-LL013006
ES-LL023009	ES-LL030011	ES-LL023015	ES-LL013012
ES-LL016016	ES-LL020020-1	ES-LL025019	ES-LL025025
ES-LL030030	ES-LL010015	ES-LL025046	
ES-LL057011	ES-LL064014		

# WW+W Series

Part Number: ES-FS2216WW+W-196-24-Y

Model	Tunable CCT	LM/M	Power/M	FPC copper
ES-FS2216WW+W-196-24-Y	1800-6500 K K	1100LM	<12W	3OZ



### Controller

Product No.	Description
4.02.128	12-24VDC 3A*2CH Max.6A 72W/144W(12V/24V)

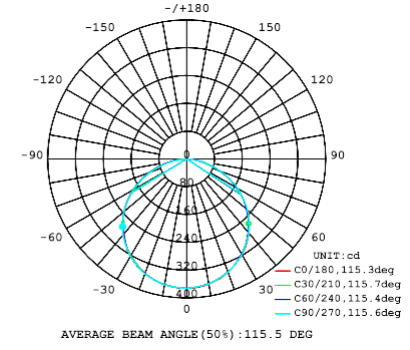

Strip length: CE:500CM UL:16.4FT

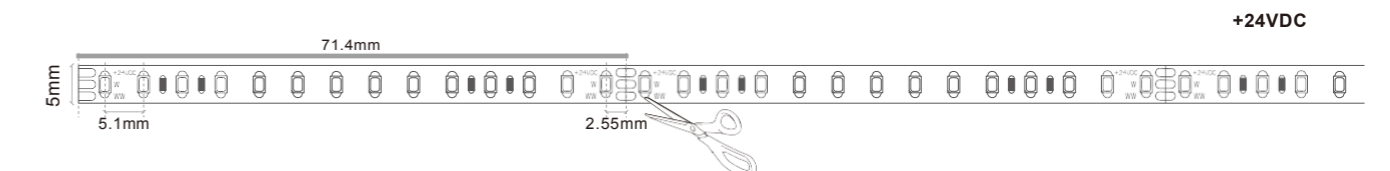

### IP Rating:

- IP20---Non waterproof
- IP54---Nano coated
- IP65---Silicon coated
- IP67---Silicon coated & Wrapped heat shrink tube
- IP67---PVC extrusion
- IP67---Silicon extrusion
- IP67---Silicon tube(transparent)
- IP68---Silicon tube(transparent) & Inject silicon glue

### AL. profiles (mm)

ES-LL017009	ES-LL024011	ES-LL017015	ES-LL013006
ES-LL023009	ES-LL030011	ES-LL023015	ES-LL013012
ES-LL016016	ES-LL020020-1	ES-LL025019	ES-LL025025
ES-LL030030	ES-LL010015	ES-LL025046	
ES-LL057011	ES-LL064014		

**MULTICOLOR**



# Digital LED Tape Light

## Product Features

1. Low Consumption,Excellent heat dissipation(<50°C),Long lifespan(>50000H), Reisting UV.
2. Two types for options:Digital IC inside LED and digital IC on the FPC.
3. Color changing and cascade effect .
4. For waterproof rate,IP20,IP54,IP65,IP67 can be possible.
5. For Controllers,there are "24-key magic controller,and DMX512 system" available.

# ES-FS5050RGB-96-12-Y

①

②

③

④

⑤

1

**LED Type**  
SMD5050 | SMD3535

2

**Color**  
RGB Digital

3

**LED Qty.per meter**  
96 | 60 | 30

**Input DC Voltage**  
12VDC | 5VDC

4

5

**IP Index**  
IP 20 | IP54 | IP67



# Digital LED Tape Light

Part Number:ES-FS5050RGB-96-12-Y(Digital)

One LED Broken, signal transmit without interruption.

Model	Color	Power/M	FPC copper
ES-FS5050RGB-96-12-Y(Digital)		<14.4W	3OZ



### Controller



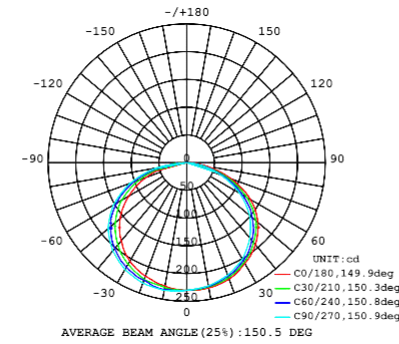



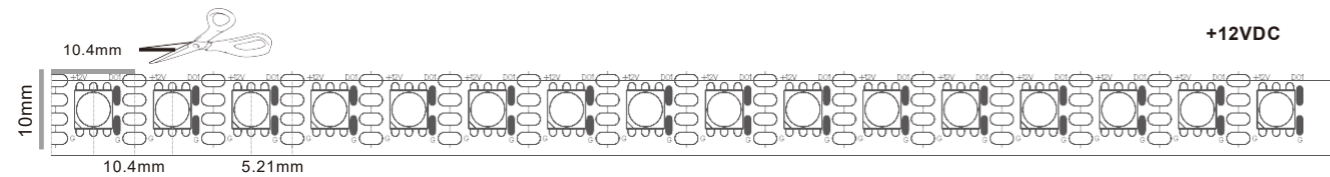









Product No.	Description
4.02.157	Pixel controller App Control DC5V-24V, up to 2048 pixels
4.02.067-1	DMX512 decoder 5-24VDC SPI 512 channels





Strip length: CE:500CM UL:16.4FT



### AL. profiles (mm)

 ES-LL017009	 ES-LL024011	 ES-LL017015	 ES-LL013006
 ES-LL023009	 ES-LL030011	 ES-LL023015	 ES-LL013012
 ES-LL016016	 ES-LL020020-1	 ES-LL025019	 ES-LL025025
 ES-LL030030	 ES-LL010015	 ES-LL025046	
 ES-LL057011	 ES-LL064014		

### IP Rating:

- IP20---Non waterproof 
- IP54---Nano coated 
- IP67---Silicon tube(transparent) 

# Digital LED Tape Light

Part Number:ES-FS5050RGB-60-12-Y(Digital)

One LED Broken, signal transmit without interruption.

Model	Color	Power/M	FPC copper
ES-FS5050RGB-60-12-Y(Digital)		<10W	3OZ



### Controller



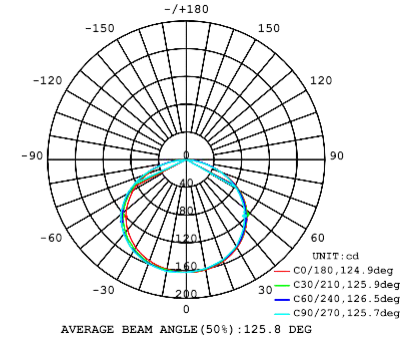



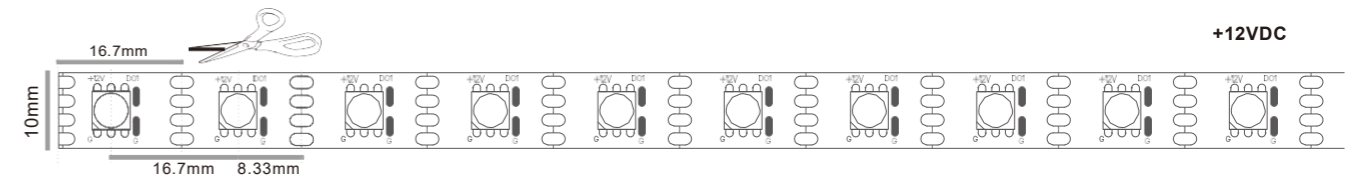









Product No.	Description
4.02.157	Pixel controller App Control DC5V-24V, up to 2048 pixels
4.02.067-1	DMX512 decoder 5-24VDC SPI 512 channels





Strip length: CE:500CM UL:16.4FT



### AL. profiles (mm)

 ES-LL017009	 ES-LL024011	 ES-LL017015	 ES-LL013006
 ES-LL023009	 ES-LL030011	 ES-LL023015	 ES-LL013012
 ES-LL016016	 ES-LL020020-1	 ES-LL025019	 ES-LL025025
 ES-LL030030	 ES-LL010015	 ES-LL025046	
 ES-LL057011	 ES-LL064014		

### IP Rating:

- IP20---Non waterproof 
- IP54---Nano coated 
- IP67---Silicon tube(transparent) 

# Digital LED Tape Light



Part Number:ES-FS3535RGB-120-5-Y(Digital)

One LED Broken, signal transmit without interruption.

Model	Color	Power/M	FPC copper
ES-FS3535RGB-120-5-Y(Digital)		<6W	3OZ



### Controller

Product No.	Description	
4.02.157	Pixel controller App Control DC5V-24V, up to 2048 pixels	
4.02.067-1	DMX512 decoder 5-24VDC SPI 512 channels	

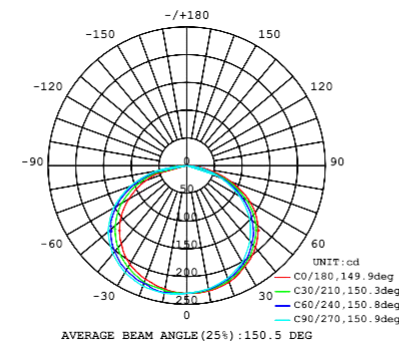

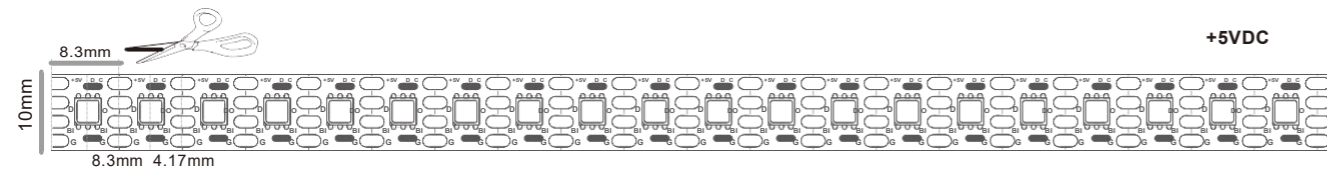

Strip length: CE:500CM



















**Remark**  
★ Must be installed with LED Aluminum profile

### IP Rating:

- IP20---Non waterproof 
- IP54---Nano coated 
- IP67---Silicon tube(transparent) 

### AL. profiles (mm)

 ES-LL017009	 ES-LL024011	 ES-LL017015	 ES-LL013006
 ES-LL023009	 ES-LL030011	 ES-LL023015	 ES-LL013012
 ES-LL016016	 ES-LL020020-1	 ES-LL025019	 ES-LL025025
 ES-LL030030	 ES-LL010015	 ES-LL025046	
 ES-LL057011	 ES-LL064014		

# Digital LED Tape Light



Part Number:ES-FS5050RGB-60-12-Y(Digital)

One Group Broken, signal transmit without interruption.

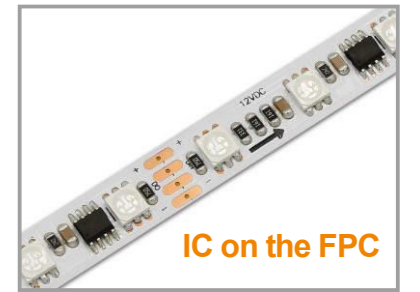
Model	Color	Power/M	FPC copper
ES-FS5050RGB-60-12-Y(Digital)		<14.4W	3OZ



### Controller



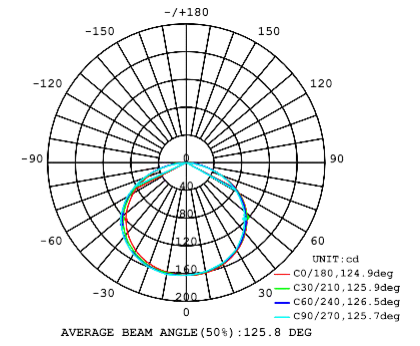

Product No.	Description	
4.02.124-1	Mini pixel controller RF remote 5-24VDC	
4.02.067-1	DMX512 decoder 5-24VDC SPI 512 channels	

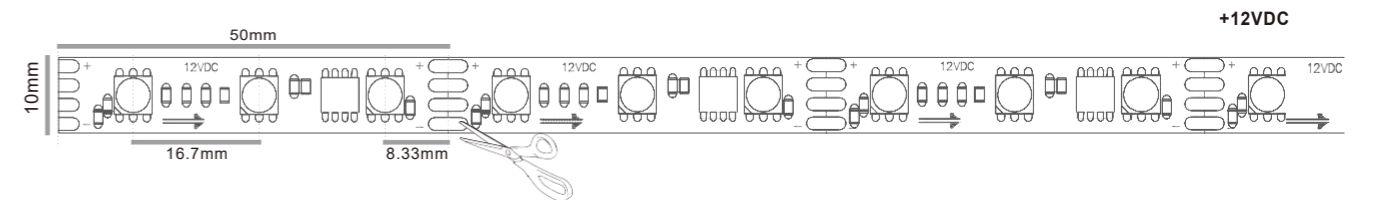

















Strip length: CE:500CM UL:16.4FT



### IP Rating:

- IP20---Non waterproof 
- IP54---Nano coated 
- IP67---PVC extrusion 
- IP67---Silicon extrusion 
- IP67---Silicon tube(transparent) 

### AL. profiles (mm)

 ES-LL017009	 ES-LL024011	 ES-LL017015	 ES-LL013006
 ES-LL023009	 ES-LL030011	 ES-LL023015	 ES-LL013012
 ES-LL016016	 ES-LL020020-1	 ES-LL025019	 ES-LL025025
 ES-LL030030	 ES-LL010015	 ES-LL025046	
 ES-LL057011	 ES-LL064014		

# Digital LED Tape Light

Part Number: ES-FS5050RGB-30-12-Y(Digital)

**One Group Broken, signal transmit without interruption.**

Model	Color	Power/M	FPC copper
ES-FS5050RGB-30-12-Y(Digital)		<7.2W	20Z



### Controller

Product No.	Description	
4.02.124-1	Mini pixel controller RF remote 5-24VDC	
4.02.067-1	DMX512 decoder 5-24VDC SPI 512 channels	

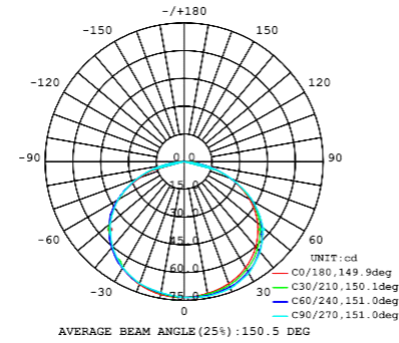

Strip length: CE:500CM UL:16.4FT

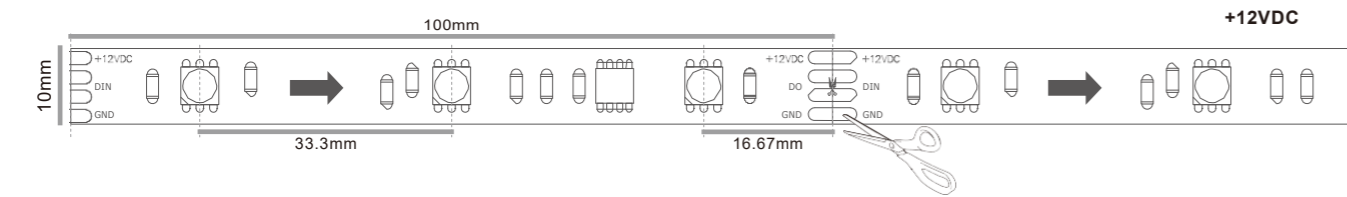

















### IP Rating:

- IP20---Non waterproof
- IP54---Nano coated
- IP67---PVC extrusion
- IP67---Silicon extrusion
- IP67---Silicon tube(transparent)



### AL. profiles (mm)

 ES-LL017009	 ES-LL024011	 ES-LL017015	 ES-LL013006
 ES-LL023009	 ES-LL030011	 ES-LL023015	 ES-LL013012
 ES-LL016016	 ES-LL020020-1	 ES-LL025019	 ES-LL025025
 ES-LL030030	 ES-LL010015	 ES-LL025046	
 ES-LL057011	 ES-LL064014		

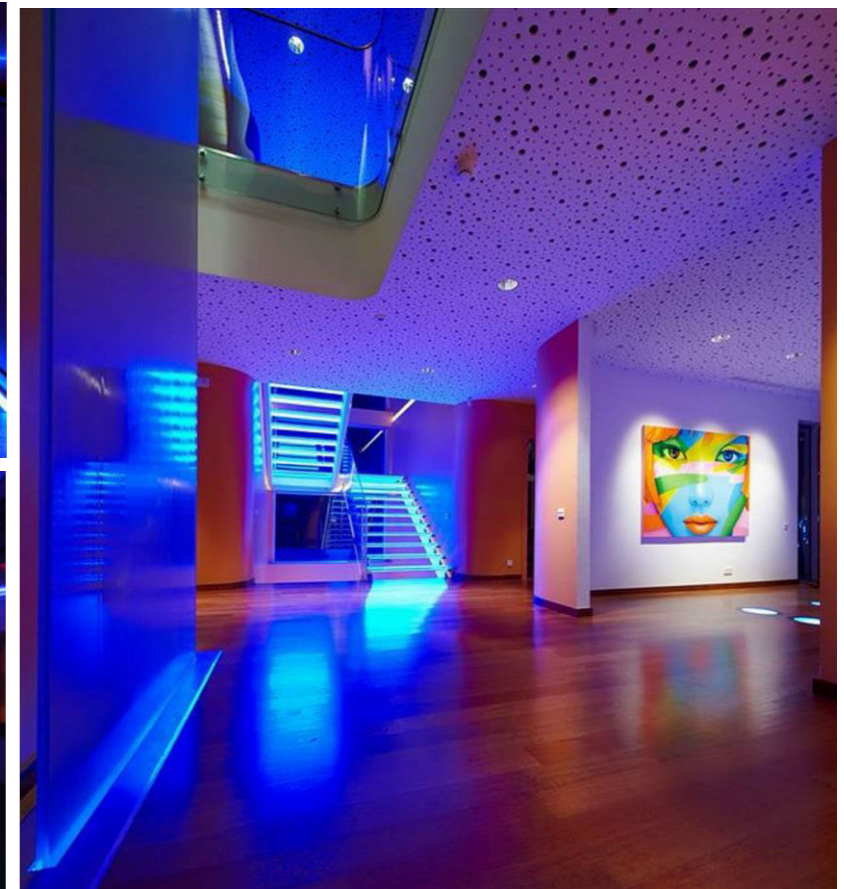
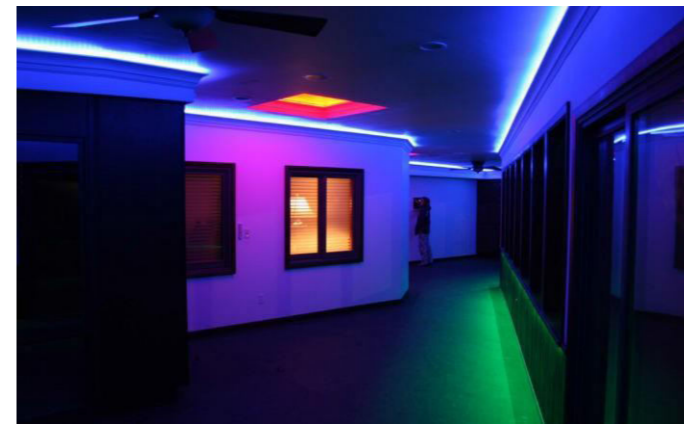

LED Strip Light

LED Strip Light Accessory

Aluminum Profile

LED Linear Luminaire

LED Panel Light

LED Panel Light Accessory

LED Strip Light

LED Strip Light Accessory

Aluminum Profile

LED Linear Luminaire

LED Panel Light

LED Panel Light Accessory

# NEON



Supply Top-view and Side-view type of LED Flex Neon Light.

IP65 protection.

Completed and colorful accessories for options.

Better performance than market ones.



# ES-FS2216C-240-24

- ①
- ②
- ③
- ④

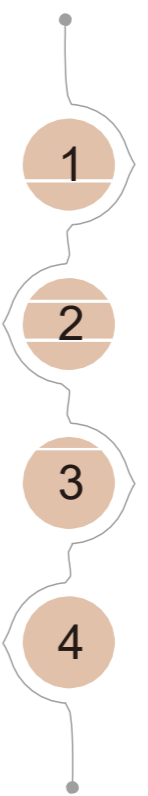

**LED Type**  
SMD2216 | SMD3535

**Color**  
2700-6500K  
RGB | WW+W

**LED Qty. per meter**  
240 | 224 | 120

**Input DC Voltage**  
24VDC

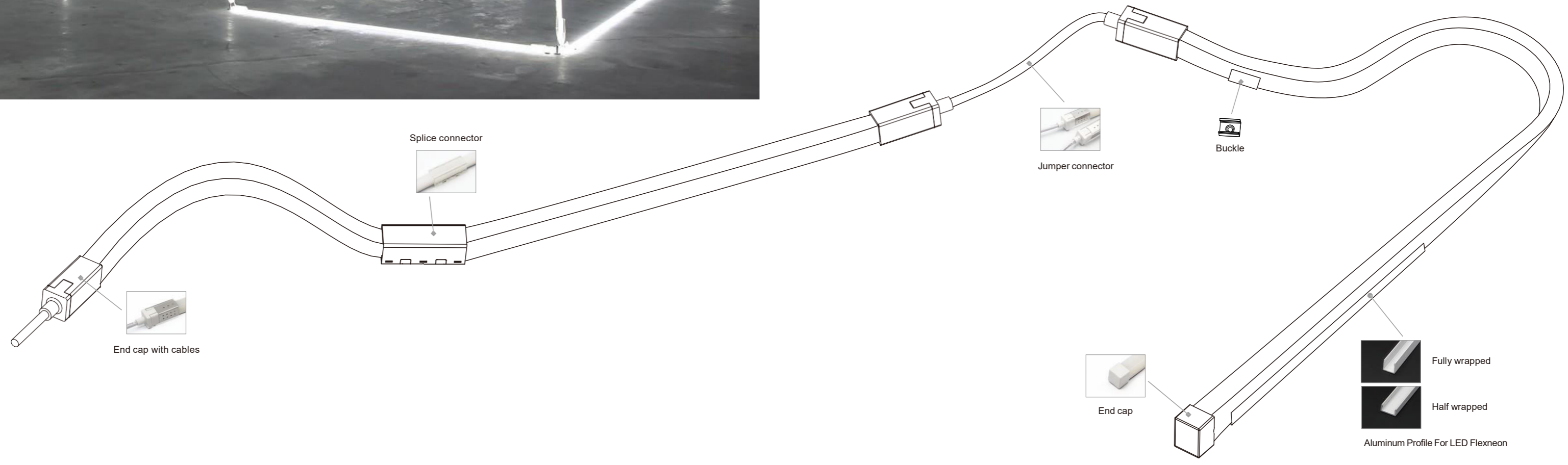

## Single Color Top View

Part Number: ES-FS2216C-240-24-Y

Model	Color temp.	LM/M	Power/M	CRI (Ra)	FPC copper
ES-FS2216WW-240-24-Y	2700K	1150LM	<14.4W	90+	3OZ
ES-FS2216WW-240-24-Y	3000K	1150LM	<14.4W	90+	3OZ
ES-FS2216NW-240-24-Y	4000K	1200LM	<14.4W	90+	3OZ
ES-FS2216PW-240-24-Y	6500K	1200LM	<14.4W	90+	3OZ



### Recommended Accessories

4.03.01.015	End cap	
1.11.02.001	End cap with cables	
1.11.02.012	Jumper connector	
1.11.02.013	Splice connector	
08.07.01.041	Full a pack	
08.07.01.042	Half a pack	
4.03.02.006	Buckle	
4.03.04.003	Screw	

Strip length: CE:500CM UL:16.4FT

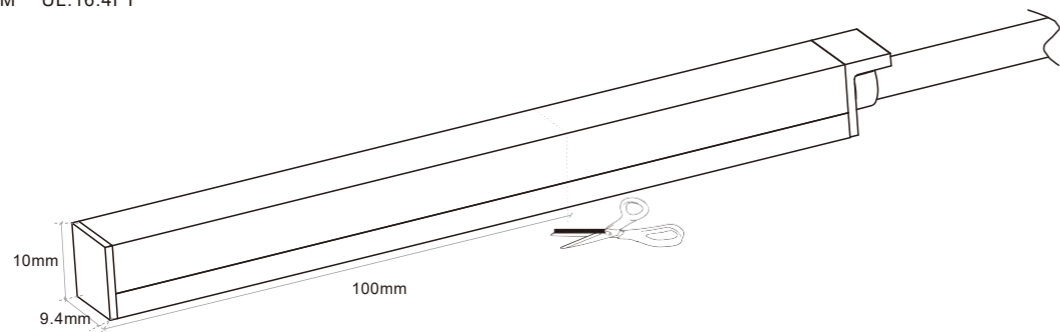

## CCT Tunable Top View

Part Number: ES-FS2216WW+W-224-24-Y

Model	Tunable CCT	LM/M	Power/M	CRI (Ra)	FPC copper
ES-FS2216WW+W-224-24-Y		850LM	<14.4W	90+	3OZ



### Recommended Accessories

4.02.128	12-24VDC 3A*2CH Max.6A 72W/144W(12V/24V)	
4.03.01.015	End cap	
1.11.02.014	End cap with cables	
08.07.01.041	Full a pack	
08.07.01.042	Half a pack	
4.03.02.006	Buckle	
4.03.04.003	Screw	

Strip length: CE:500CM UL:16.4FT

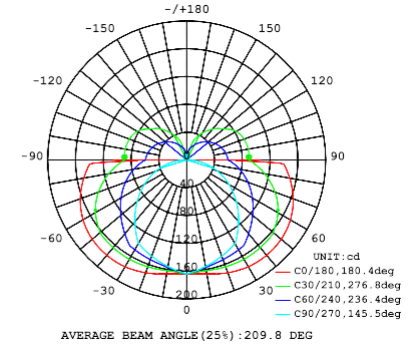
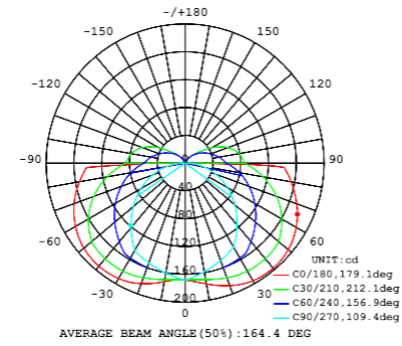
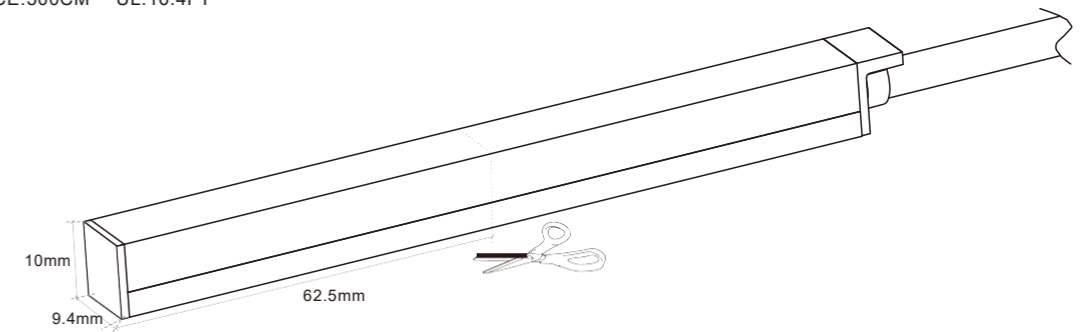

## RGB Top View

Part Number: ES-FS3535RGB-120-24-Y

Model	Wave lengths	LM/M	Power/M	FPC copper
ES-FS3535RGB-120-24-Y	620-627 NM NM	450LM	<14.4W	30Z
	525-530 NM NM			
	470-475 NM NM			



### Recommended Accessories

4.02.127	12-24VDC 3A*3CH Max.9A 108W/216W(12V/24V)	
4.03.01.015	End cap	
1.11.02.014	End cap with cables	
08.07.01.041	Full a pack	
08.07.01.042	Half a pack	
4.03.02.006	Buckle	
4.03.04.003	Screw	

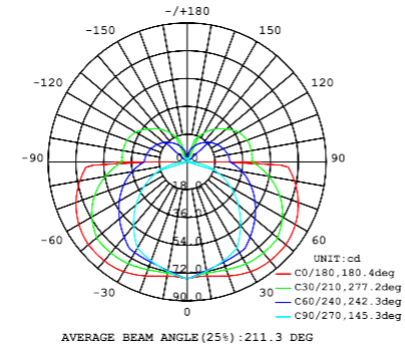

Strip length: CE:500CM UL:16.4FT

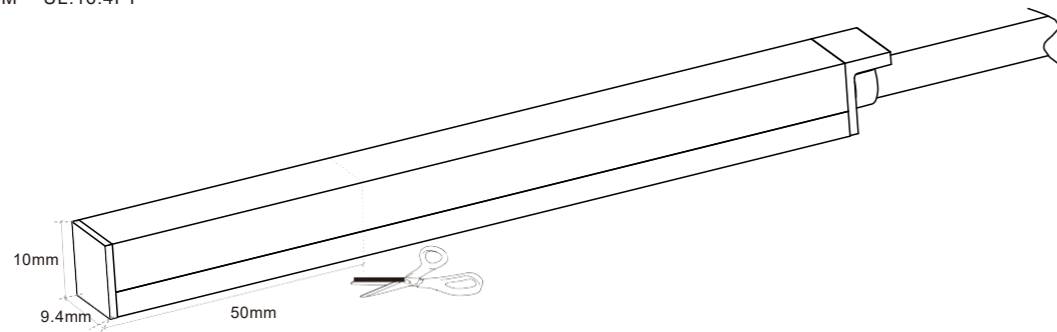

## LED Flex Neon Light instruction and caution

Parallely ✓

Straighten the LED strip parallely during normal service.

Front Back  
R ≥ 120mm ✓

Hold the curve of LED strip with its front side up and back side down during normal service.  
(Attention: keep the curved radian ≥ 120mm)

R=120mm ✓

During normal service, once need a turning, must hold the the curve of LED strip with its front side up and back side down. (Attention: keep the curved radian ≥ 120mm)

Back Front ✗

During normal service, do not bend LED strips with its back side up and front side down, as well as from the side.

Distortion ✗

The LED strip cannot be distorted during normal service.

A right-angle ✗

During normal service,once need a turning,must keep the curved radian ≥ 120mm and couldn't be a right-angle.

✗

During normal service,don't bend LED strips from the side.



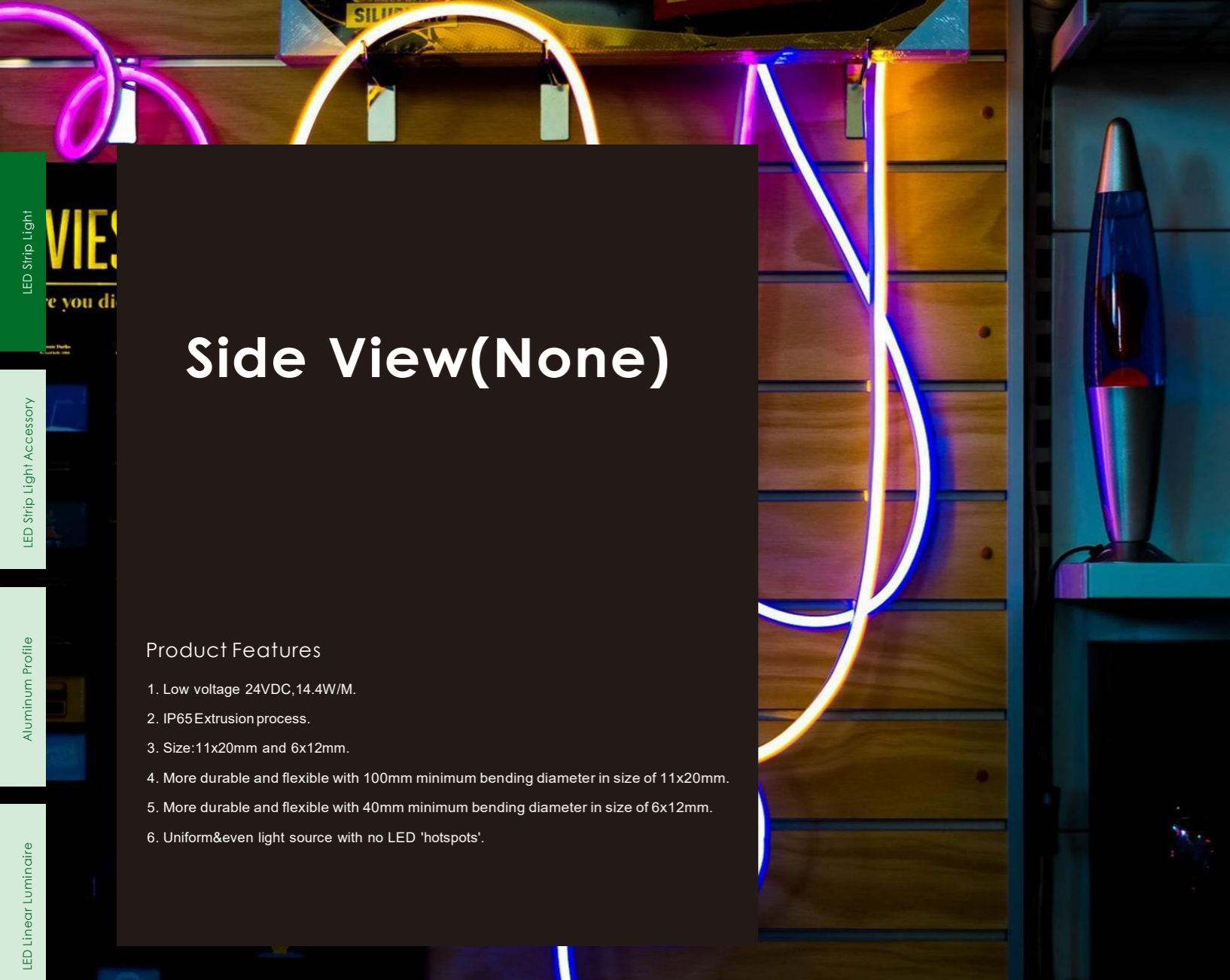

LED Strip Light  
LED Strip Light Accessory  
Aluminum Profile  
LED Linear Luminaire

# Side View(None)

**Product Features**

1. Low voltage 24VDC, 14.4W/M.
2. IP65 Extrusion process.
3. Size: 11x20mm and 6x12mm.
4. More durable and flexible with 100mm minimum bending diameter in size of 11x20mm.
5. More durable and flexible with 40mm minimum bending diameter in size of 6x12mm.
6. Uniform & even light source with no LED 'hotspots'.

## ES-FS2835C-60-24

- ①
- ②
- ③
- ④

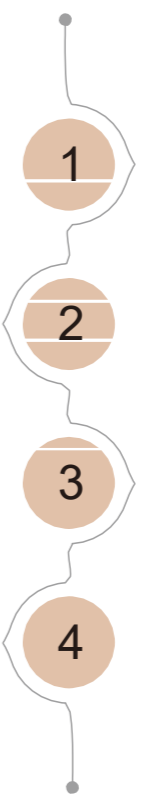

**LED Type**  
SMD3528 | SMD2835  
SMD5050

**Color**  
2700-4000K  
RGB | WW+W

**LED Qty. per meter**  
120 | 96 | 60

**Input DC Voltage**  
24VDC

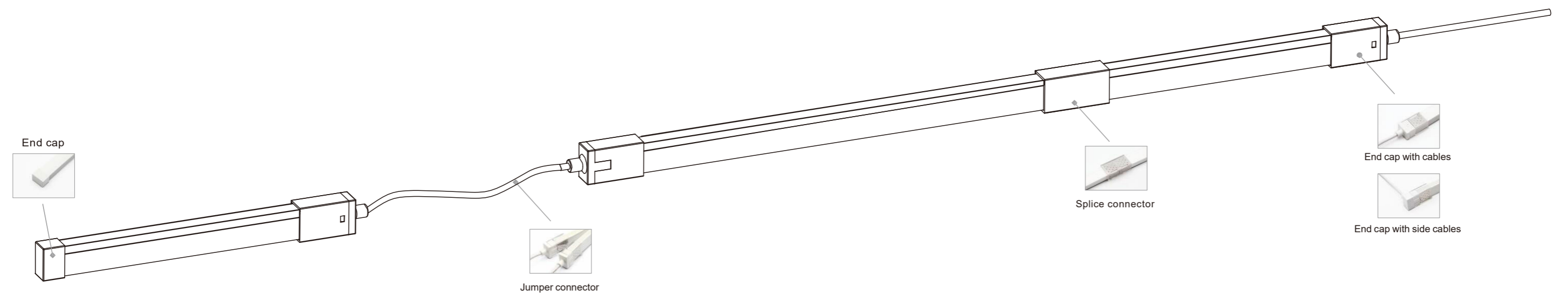



## Single Color Side View

Part Number:ES-FS2835C-60-24-Y

Model	Color temp.	LM/M	Power/M	CRI (Ra)	FPC copper
ES-FS2835WW-60-24-Y	2300K	270LM	<15W	94+	3OZ
ES-FS2835WW-60-24-Y	3000K	295LM	<15W	94+	3OZ
ES-FS2835WW-60-24-Y	3500K	295LM	<15W	94+	3OZ
ES-FS2835NW-60-24-Y	4000K	315LM	<15W	94+	3OZ
ES-FS2835NW-60-24-Y	5000K	315LM	<15W	94+	3OZ

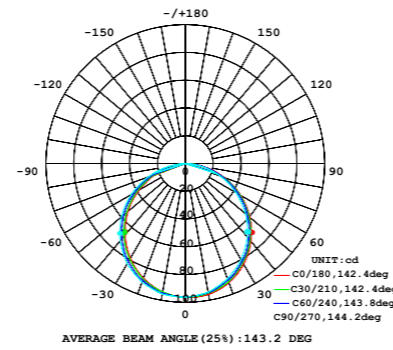

### Recommended Accessories

4.03.01.030	End cap	
1.11.02.007	End cap with cables	
1.11.02.008	End cap with side cables	
1.11.02.016	Jumper connector	
1.11.02.009	Splice connector	
3.08.01.031	Buckle	
4.03.04.003	Screw	

Strip length: CE:500CM UL:16.4FT

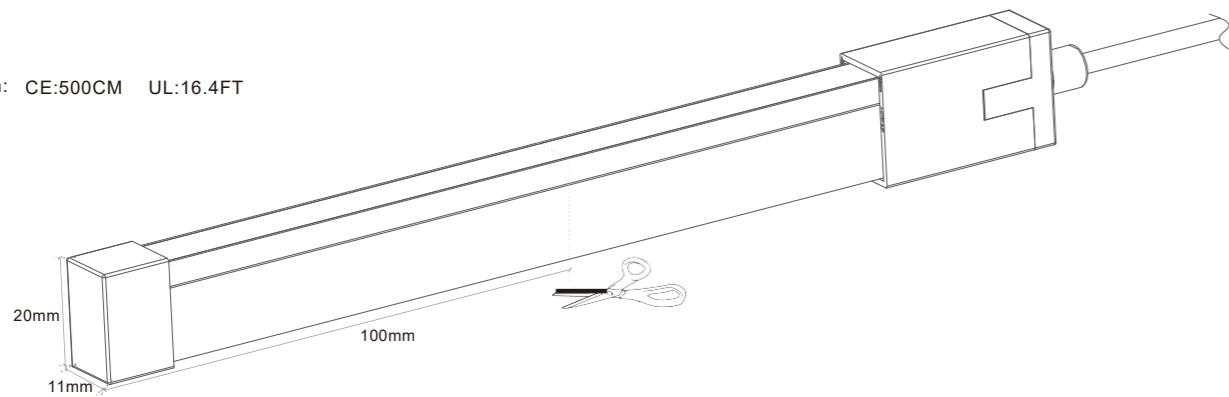

## Single Color Side View Constant Current

Part Number:ES-FS2835CC-60-24-Y

Model	Color temp.	LM/M	Power/M	CRI (Ra)	FPC copper
ES-FS2835WWC-60-24-Y	2300K	270LM	<15W	94+	3OZ
ES-FS2835WWC-60-24-Y	3000K	295LM	<15W	94+	3OZ
ES-FS2835WWC-60-24-Y	3500K	295LM	<15W	94+	3OZ
ES-FS2835NWC-60-24-Y	4000K	315LM	<15W	94+	3OZ
ES-FS2835NWC-60-24-Y	5000K	315LM	<15W	94+	3OZ

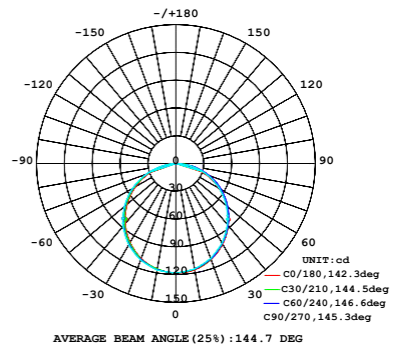

### Recommended Accessories

4.03.01.030	End cap	
1.11.02.007	End cap with cables	
1.11.02.008	End cap with side cables	
1.11.02.016	Jumper connector	
1.11.02.009	Splice connector	
3.08.01.031	Buckle	
4.03.04.003	Screw	

Strip length: CE:1000CM UL:21.4FT

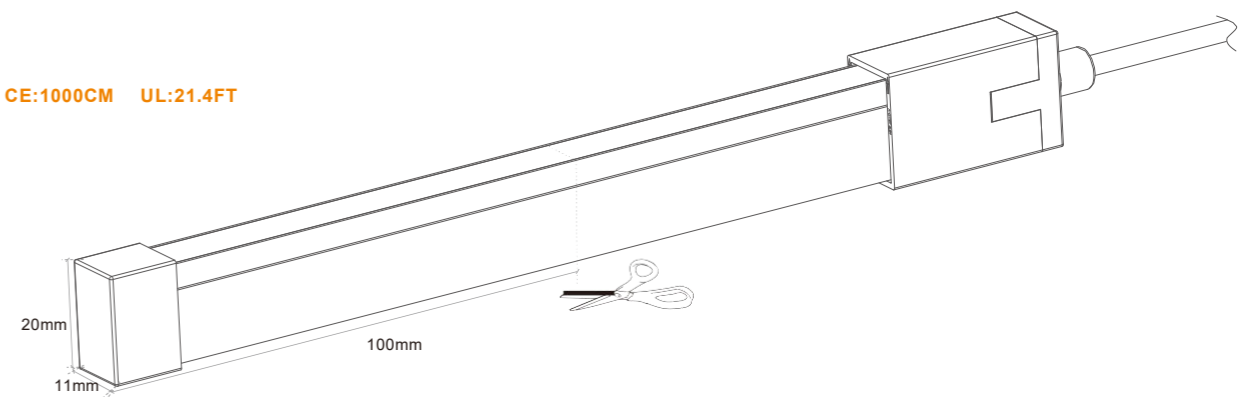

## Single Color Side View

Part Number: ES-FS3528C-120-24-Y

Model	Color temp.	LM/M	Power/M	CRI (Ra)	FPC copper
ES-FS3528WW-120-24-Y	2700K	170LM	<10W	90+	3OZ
ES-FS3528WW-120-24-Y	3000K	170LM	<10W	90+	3OZ
ES-FS3528WW-120-24-Y	3500K	180LM	<10W	90+	3OZ
ES-FS3528NW-120-24-Y	4000K	190LM	<10W	90+	3OZ

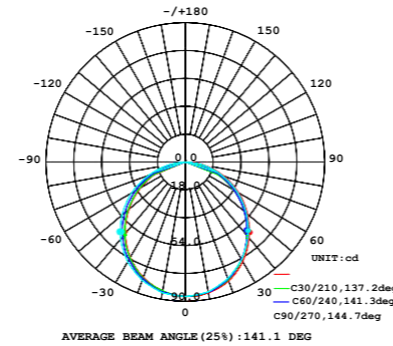

4.03.01.029	End cap	
1.11.02.004	End cap with cables	
1.11.02.005	End cap with side cables	
1.11.02.015	Jumper connector	
1.11.02.006	Splice connector	
3.08.02.011	Buckle	
4.03.04.008	Screw	

Strip length: CE:500CM UL:16.4FT

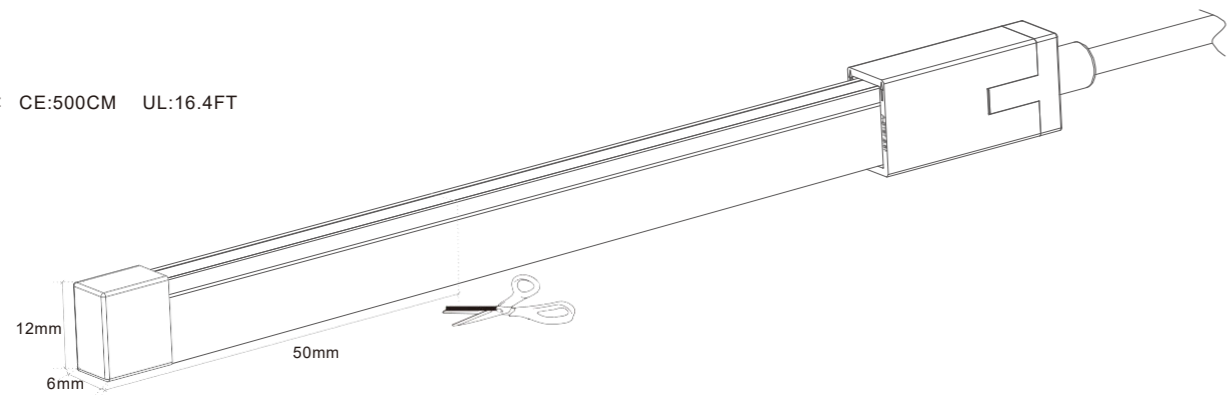

## Single Color Side View Constant Current

Part Number: ES-FS3528CC-120-24-Y

Model	Color temp.	LM/M	Power/M	CRI (Ra)	FPC copper
ES-FS3528WWC-120-24-Y	2700K	170LM	<10W	90+	3OZ
ES-FS3528WWC-120-24-Y	3000K	170LM	<10W	90+	3OZ
ES-FS3528WWC-120-24-Y	3500K	180LM	<10W	90+	3OZ
ES-FS3528NWC-120-24-Y	4000K	190LM	<10W	90+	3OZ

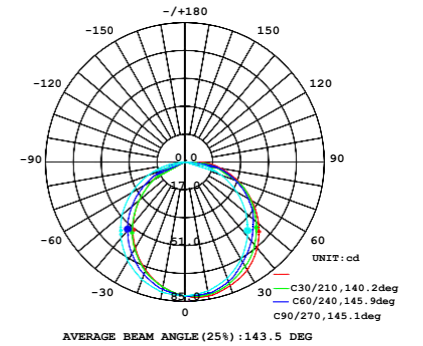

4.03.01.029	End cap	
1.11.02.004	End cap with cables	
1.11.02.005	End cap with side cables	
1.11.02.015	Jumper connector	
1.11.02.006	Splice connector	
3.08.02.011	Buckle	
4.03.04.008	Screw	

Strip length: CE:1000CM UL:21.4FT

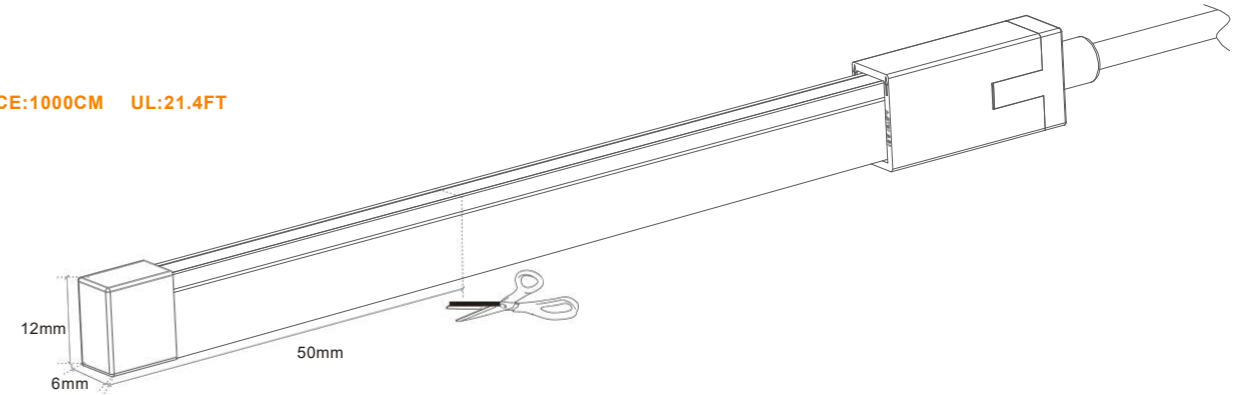

Part Number:ES-FS5050RGB-96-24-Y

Model	Wave lengths	LM/M	Power/M	FPC copper
ES-FS5050RGB-96-24-Y	620-627 NM NM 525-530 NM NM 470-475 NM NM	100LM	<14.4W	30Z

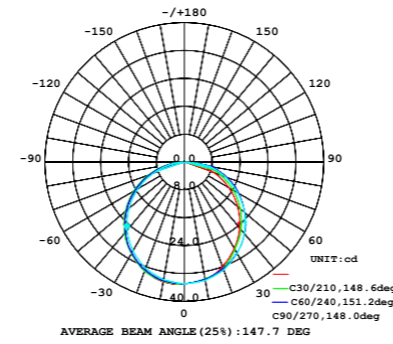

4.02.127	12-24VDC 3A*3CH Max.9A 108W/216W(12V/24V)	
4.03.01.030	End cap	
1.11.02.010	End cap with cables	
1.11.02.017	Jumper connector	
1.11.02.011	Splice connector	
3.08.01.031	Buckle	
4.03.04.003	Screw	

Strip length: CE:500CM UL:16.4FT

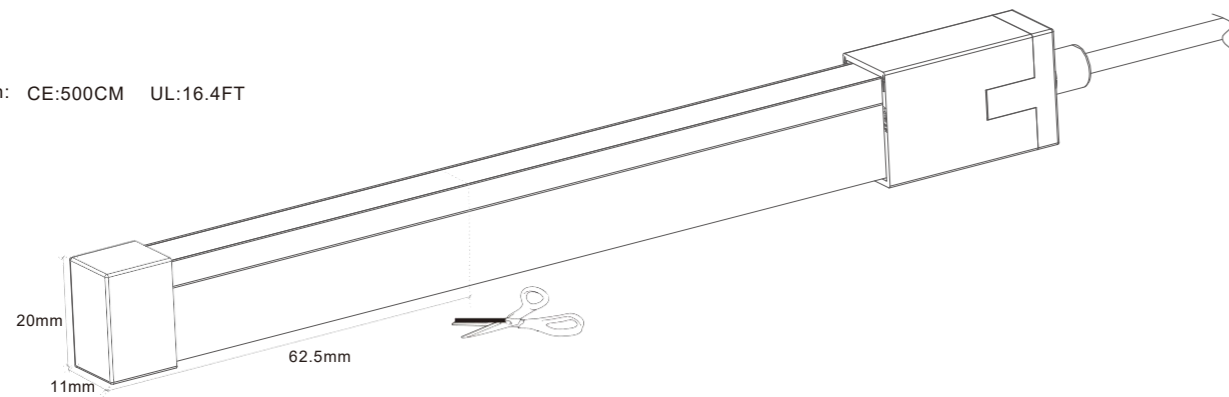

Part Number:ES-FS5050RGB-60-24-Y

Model	Wave lengths	LM/M	Power/M	FPC copper
ES-FS5050RGB-60-24-Y	620-627 NM NM 525-530 NM NM 470-475 NM NM	80LM	<14.4W	30Z

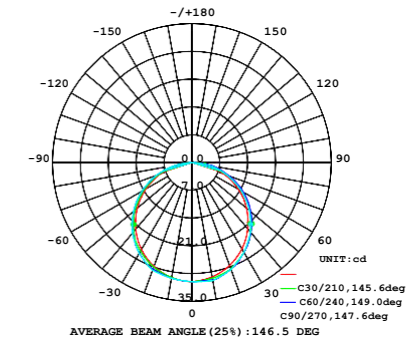

4.02.127	12-24VDC 3A*3CH Max.9A 108W/216W(12V/24V)	
4.03.01.030	End cap	
1.11.02.010	End cap with cables	
1.11.02.017	Jumper connector	
1.11.02.011	Splice connector	
3.08.01.031	Buckle	
4.03.04.003	Screw	

Strip length: CE:500CM UL:16.4FT

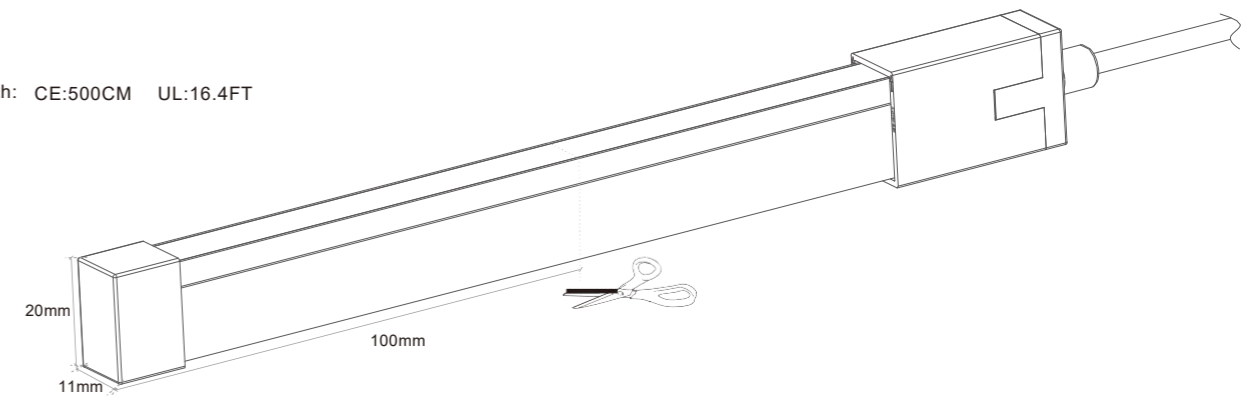

# 10M RGB Color

Part Number:ES-FS5050RGBC-60-24-Y

# RGB Side View Constant Current

Model	Wave lengths	LM/M	Power/M	FPC copper
ES-FS5050RGBC-60-24-Y	620-627 NM NM	150LM	<14.4W	30Z
	525-530 NM NM			
	470-475 NM NM			

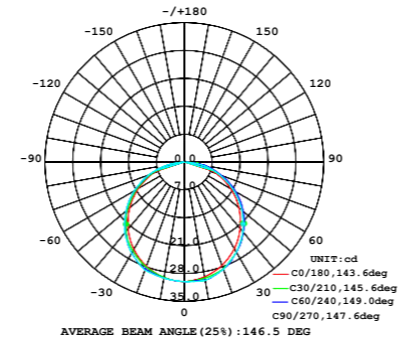

### Recommended Accessories

4.02.127	12-24VDC 3A*3CH Max.9A 108W/216W(12V/24V)	
4.03.01.030	End cap	
1.11.02.010	End cap with cables	
1.11.02.017	Jumper connector	
1.11.02.011	Splice connector	
3.08.01.031	Buckle	
4.03.04.003	Screw	

Strip length: CE:1000CM UL:32.8FT

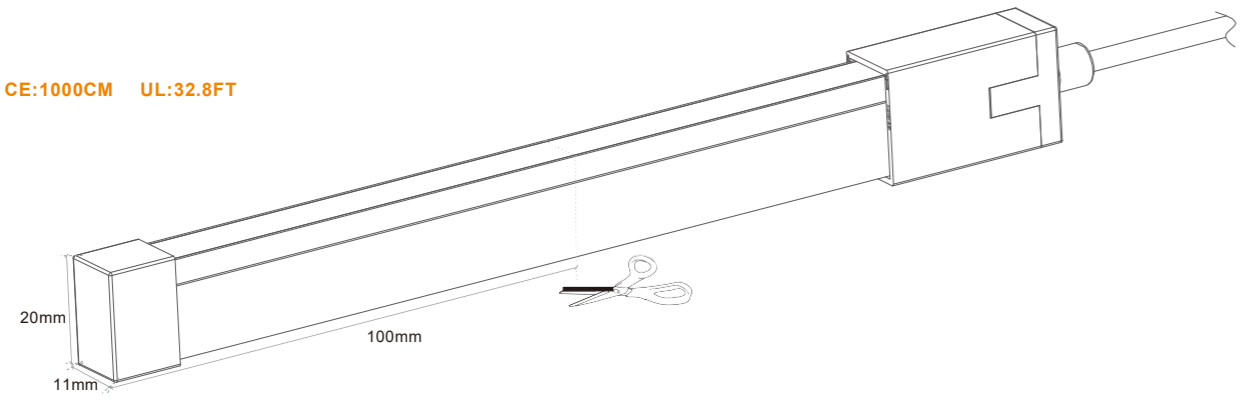

Part Number:ES-FS2835WW+W-120-24-Y

# CCT Tunable Side View

Model	Tunable CCT	LM/M	Power/M	CRI (Ra)	FPC copper
ES-FS2835WW+W-120-24-Y		345LM	<15W	94+	30Z

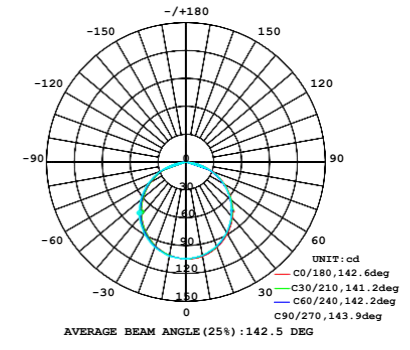

### Recommended Accessories

4.02.128	12-24VDC 3A*2CH Max.6A 72W/144W(12V/24V)	
4.03.01.030	End cap	
1.11.02.010	End cap with cables	
1.11.02.017	Jumper connector	
1.11.02.011	Splice connector	
3.08.01.031	Buckle	
4.03.04.003	Screw	

Strip length: CE:500CM UL:16.4FT

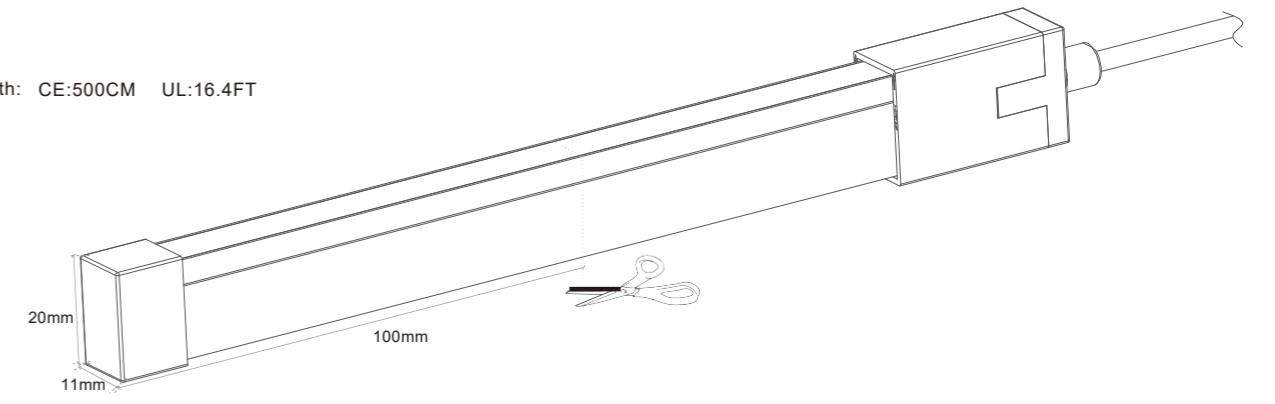

NEON

Light

Supply Top-View and Side-View type of LED Flex NEON Light.

Better performance than market ones.

# 120VAC LED Tape Light

Part Number: ES-HS3528CC-144-120V-Y

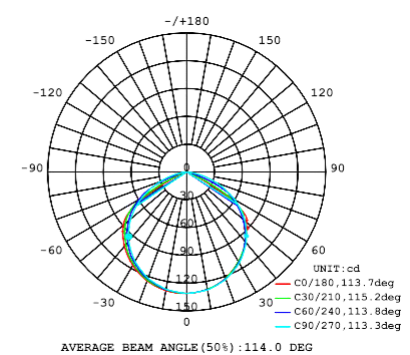

Model	Color temp. Wave lengths	LM/FT	Power/FT	Light efficiency	CRI (Ra)	Power Factor
ES-HS3528WWC-144-120V-Y	2400K	162LM	<2.5W	65LM/W	90+	PF>0.9
ES-HS3528WWC-144-120V-Y	2700K	175LM	<2.5W	70LM/W	90+	PF>0.9
ES-HS3528WWC-144-120V-Y	3000K	175LM	<2.5W	70LM/W	90+	PF>0.9
ES-HS3528WWC-144-120V-Y	3500K	175LM	<2.5W	70LM/W	90+	PF>0.9
ES-HS3528NWC-144-120V-Y	4000K	187LM	<2.5W	75LM/W	90+	PF>0.9
ES-HS3528PWC-144-120V-Y	5000K	187LM	<2.5W	75LM/W	90+	PF>0.9
ES-HS3528RC-144-120V-Y	620-625 NM NM	---	<2.5W	---	---	PF>0.9
ES-HS3528YC-144-120V-Y	585-590 NM NM	---	<2.5W	---	---	PF>0.9
ES-HS3528GC-144-120V-Y	517-522 NM NM	---	<2.5W	---	---	PF>0.9
ES-HS3528BC-144-120V-Y	465-470 NM NM	---	<2.5W	---	---	PF>0.9



Strip length: 164FT

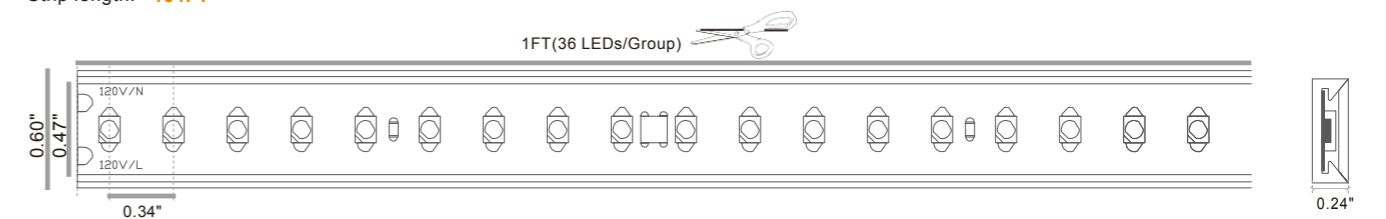

### 1. End cap, End cap with power cord



End cap  
1.11.01.012



V2 End cap with power cord  
1.11.01.031



V2 End cap with power plug  
1.11.01.032



V2 Extended cord (male and female) with end cap and power plug  
1.11.01.033



Extended cord (male and female)  
3.09.20.009

### 3. Connectors (Order Qty. no MOQ)



Waterproof 2 PIN connector  
3.09.16.028



L snap connector  
1.11.01.009



Splice connector  
1.11.01.008



Jumper (24")  
1.11.01.015

### 4. Mounting Accessories



Mounting clips  
4.03.01.013



PVC channel  
4.03.05.007



Profile  
4.03.05.002

# Driverless 120VAC LED Tape Light

## Product Features

1. High light efficiency, high PF and high lumens.
2. Constant current design, overvoltage protection;
3. Complete and colorful accessories for options;
4. No line voltage cables on the backside of tape, with more stable performance.
5. Bending diameter is 4 inch;
6. No transformer box to change AC to DC, connect with line voltage directly
7. With bared power cords on one side, it's more convenient for connecting.
8. IP 65 PVC extrusion process, customized length is available. Max. length is 164FT/reel;
9. ETL, FCC certified, 5 years warranty.



IP Rating:

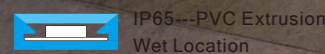

Warning: this item can't be used under water

# 120VAC LED Tape Light

Part Number:ES-HS3056CC-72-120V-Y

Model	Color temp. Wave lengths	LM/FT	Power/FT	Light efficiency	CRI (Ra)	Power Factor
ES-HS3056WWC-72-120V-Y	2400K	260LM	<4W	65LM/W	90+	PF>0.93
ES-HS3056WWC-72-120V-Y	2700K	270LM	<4W	67LM/W	90+	PF>0.93
ES-HS3056WWC-72-120V-Y	3000K	270LM	<4W	67LM/W	90+	PF>0.93
ES-HS3056WWC-72-120V-Y	3500K	300LM	<4W	75LM/W	90+	PF>0.93
ES-HS3056NWC-72-120V-Y	4000K	320LM	<4W	80LM/W	90+	PF>0.93
ES-HS3056PWC-72-120V-Y	5000K	320LM	<4W	80LM/W	90+	PF>0.93

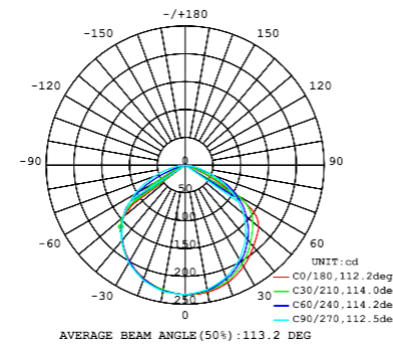

# 120VAC LED Tape Light

Part Number:ES-HS5050CC-56-120V-Y

Model	Color temp. Wave lengths	LM/FT	Power/FT	Light efficiency	CRI (Ra)	Power Factor
ES-HS5050WWC-56-120V-Y	2700K	150LM	<2W	75LM/W	90+	---
ES-HS5050WWC-56-120V-Y	3000K	150LM	<2W	75LM/W	90+	---
ES-HS5050WWC-56-120V-Y	3500K	150LM	<2W	75LM/W	90+	---
ES-HS5050NWC-56-120V-Y	4000K	160LM	<2W	80LM/W	90+	---
ES-HS5050PWC-56-120V-Y	5000K	160LM	<2W	80LM/W	90+	---
ES-HS5050RC-56-120V-Y	620-625 NM NM	---	<2W	---	---	---
ES-HS5050YC-56-120V-Y	585-590 NM NM	---	<2W	---	---	---
ES-HS5050GC-56-120V-Y	517-522 NM NM	---	<2W	---	---	---
ES-HS5050BC-56-120V-Y	465-470 NM NM	---	<2W	---	---	---

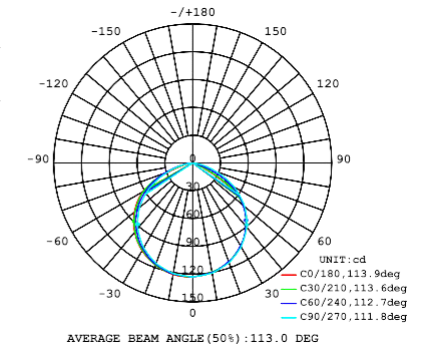

## 1. End cap, End cap with power cord

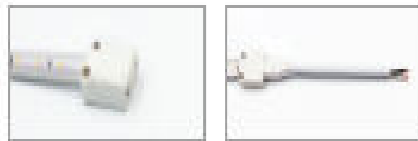

End cap 1.11.01.012  
 V2 End cap with power cord 1.11.01.031

## 2. Optional accessories(MOQ: 500pcs)



V2 End cap with power plug 1.11.01.032  
 V2 Extended cord(male and female) with end cap and power plug 1.11.01.033  
 Extended cord (male and female) 3.09.20.009

## 3. Connectors(Order Qty no MOQ)



Waterproof 2PIN connector 3.09.16.028  
 L snap connector 1.11.01.009  
 Splice connector 1.11.01.008  
 Jumper(24") 1.11.01.015

## 4. Mounting Accessories

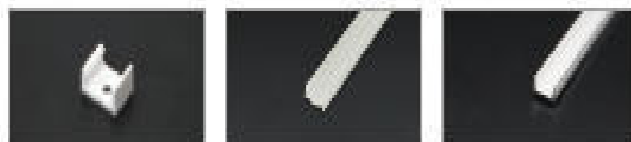

Mounting clips 4.03.01.013  
 PVC channel 4.03.05.007  
 Profile 4.03.05.002

## 1. End cap, End cap with power cord



End cap 1.11.01.012  
 V2 End cap with power cord 1.11.01.031

## 2. Optional accessories(MOQ: 500pcs)



V2 End cap with power plug 1.11.01.032  
 V2 Extended cord(male and female) with end cap and power plug 1.11.01.033

## 3. Connectors(Order Qty no MOQ)



Waterproof 2 PIN connector 3.09.16.028  
 L snap connector 1.11.01.009  
 Splice connector 1.11.01.008  
 Jumper(24") 1.11.01.015

## 4. Mounting Accessories



Mounting clips 4.03.01.013  
 PVC channel 4.03.05.007  
 Profile 4.03.05.002

# 120VAC LED Tape Light

Part Number: ES-HS3535RGBC-144-120V-Y

Model	Power/FT	LM/FT
ES-HS3535RGBC-144-120V-Y	<2W	45LM

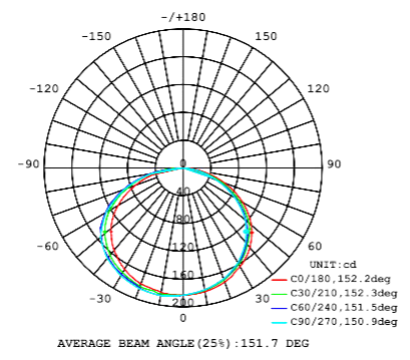

Strip length: 164FT

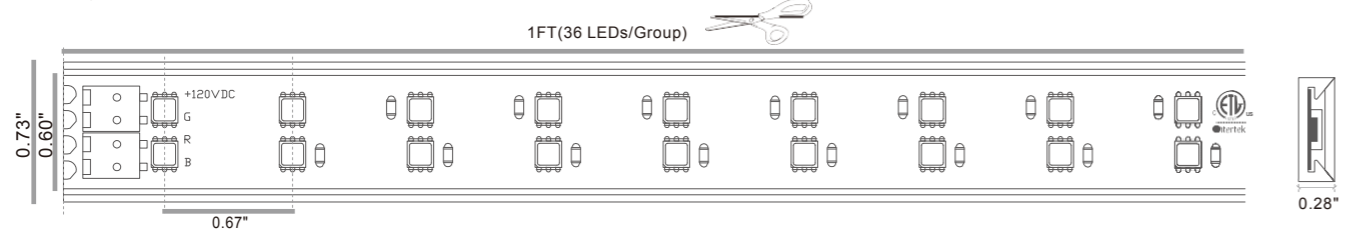

### 1. End cap, End cap with power cord



### 2. Connectors (Order Qty. no MOQ)



### 3. Mounting Accessories



LED Strip Light

LED Strip Light Accessory

Aluminum Profile

LED Linear Luminaire

LED Panel Light

LED Panel Light Accessory

LED Strip Light

LED Strip Light Accessory

Aluminum Profile

LED Linear Luminaire

LED Panel Light

LED Panel Light Accessory



# 230VAC LED Tape Light

Part Number:ES-HS3528CC-120-230V-Y



Model	Color temp. Wave lengths	LM/M	Power/M	Light efficiency	CRI (Ra)	Power Factor
ES-HS3528WWC-120-230V-Y	2700K	520LM	<8W	65LM/W	90+	PF>0.96
ES-HS3528WWC-120-230V-Y	3000K	520LM	<8W	65LM/W	90+	PF>0.96
ES-HS3528NWC-120-230V-Y	4000K	560LM	<8W	70LM/W	90+	PF>0.96
ES-HS3528PWC-120-230V-Y	6500K	560LM	<8W	70LM/W	90+	PF>0.96
ES-HS3528RC-120-230V-Y	620-625 NM NM	---	<8W	---	---	PF>0.96
ES-HS3528YC-120-230V-Y	585-590 NM NM	---	<8W	---	---	PF>0.96
ES-HS3528GC-120-230V-Y	517-522 NM NM	---	<8W	---	---	PF>0.96
ES-HS3528BC-120-230V-Y	465-470 NM NM	---	<8W	---	---	PF>0.96

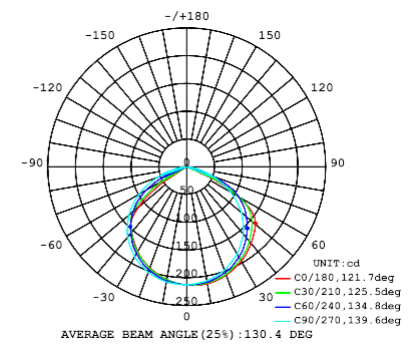

Strip length: 5000CM

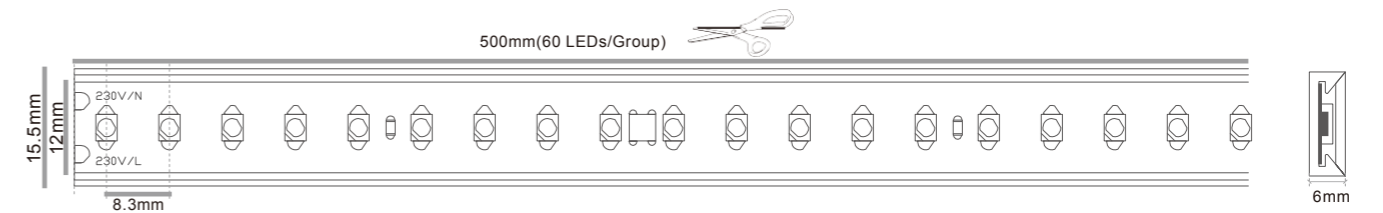

### 1. Connectors(Order Qty.no MOQ)



Waterproof Junction Box  
3.09.17.010



Waterproof 2 PIN connector  
3.09.16.028



End cap  
1.11.01.013



End cap with power cord  
1.11.01.034

### 2. End cap,End cap with power cord

### 3. Connectors(Order Qty.no MOQ)



L snap connector  
1.11.01.009



Splice connector  
1.11.01.008



Jumper  
1.11.01.018

### 4. Mounting Accessories



Mounting clips  
4.03.01.013



PVC channel  
4.03.05.007



Profile  
4.03.05.002

# Driverless 230VAC

## LED Tape Light

### Product Features

1. High light efficiency, high PF and high lumens.
2. Constant current design, overvoltage protection;
3. Complete and colorful accessories for options;
4. No line voltage cables on the backside of tape, with more stable performance.
5. Bending diameter is 10cm;
- 6.No transformer box to change AC to DC, connect with line voltage directly
- 7.With bared power cords on one side, it's more convenient for connecting.
- 8.IP 65 PVC extrusion process, customized length is available. Max.length is 50m/reel;
- 9.CE certified by TUV,5 years warranty.



IP Rating:

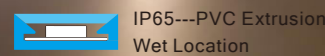

IP65---PVC Extrusion  
Wet Location

Warning: this item can't be used under water

LED Strip Light

LED Strip Light Accessory

Aluminum Profile

LED Linear Luminaire

LED Panel Light

LED Panel Light Accessory

LED Strip Light

LED Strip Light Accessory

Aluminum Profile

LED Linear Luminaire

LED Panel Light

LED Panel Light Accessory

# 230VAC LED Tape Light

Part Number: ES-HS3056CC-72-230V-Y

Model	Color temp. Wave lengths	LM/M	Power/M	Light efficiency	CRI (Ra)	Power Factor
ES-HS3056WWC-72-230-Y	2700K	1400LM	<14W	100LM/W	80+	PF>0.96
ES-HS3056WWC-72-230-Y	3000K	1400LM	<14W	100LM/W	80+	PF>0.96
ES-HS3056NWC-72-230-Y	4000K	1470LM	<14W	105LM/W	80+	PF>0.96
ES-HS3056PWC-72-230-Y	6500K	1470LM	<14W	105LM/W	80+	PF>0.96

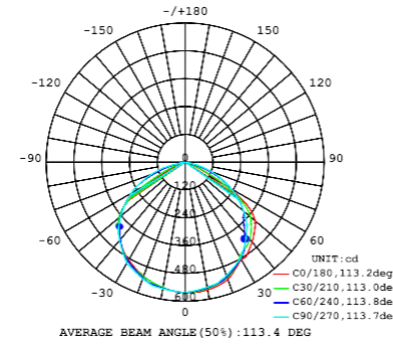

Strip length: 5000CM

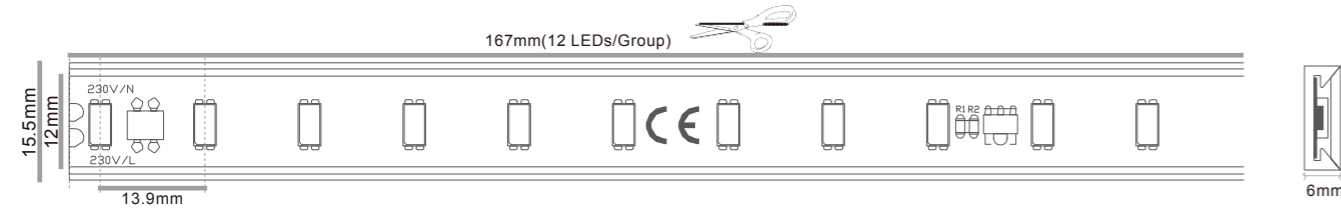

### 1. Connectors (Order Qty. no MOQ)



### 2. End cap, End cap with power cord

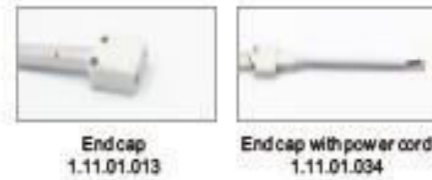

### 3. Connectors (Order Qty. no MOQ)



### 4. Mounting Accessories



# 230VAC LED Tape Light

Part Number: ES-HS5050CC-54-230V-Y

Model	Color temp. Wave lengths	LM/M	Power/M	Light efficiency	CRI (Ra)	Power Factor
ES-HS5050WWC-54-230-Y	2700K	640LM	<8W	80LM/W	90+	PF>0.96
ES-HS5050WWC-54-230-Y	3000K	640LM	<8W	80LM/W	90+	PF>0.96
ES-HS5050NWC-54-230-Y	4000K	680LM	<8W	85LM/W	90+	PF>0.96
ES-HS5050PWC-54-230-Y	6500K	680LM	<8W	85LM/W	90+	PF>0.96
ES-HS5050RC-54-230-Y	620-625 NM NM	---	<8W	---	---	---
ES-HS5050YC-54-230-Y	585-590 NM NM	---	<8W	---	---	---
ES-HS5050GC-54-230-Y	517-522 NM NM	---	<8W	---	---	---
ES-HS5050BC-54-230-Y	465-470 NM NM	---	<8W	---	---	---

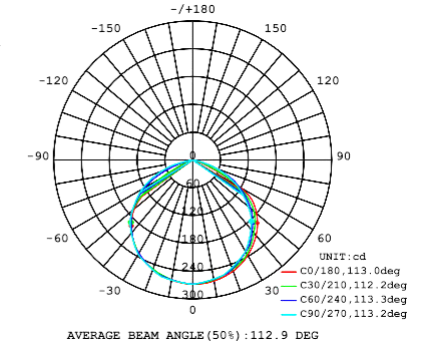

Strip length: 5000CM

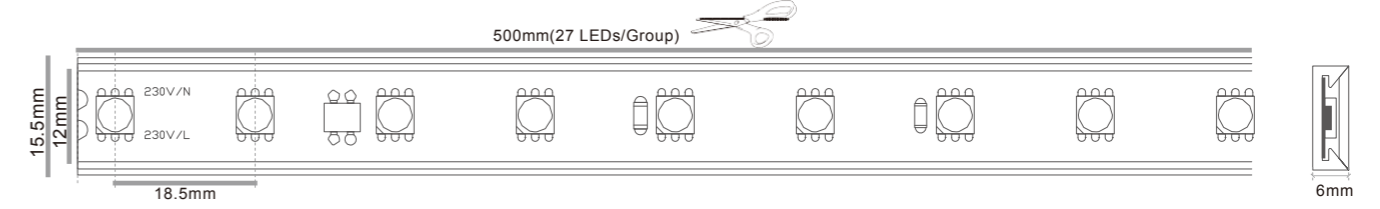

### 1. Connectors (Order Qty. no MOQ)



### 2. End cap, End cap with power cord

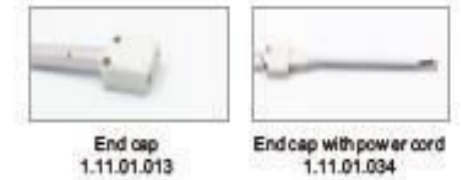

### 3. Connectors (Order Qty. no MOQ)



### 4. Mounting Accessories



**LINE VOLTAGE**



# 120VAC LED Module

Customized is available



## Zhaga Series

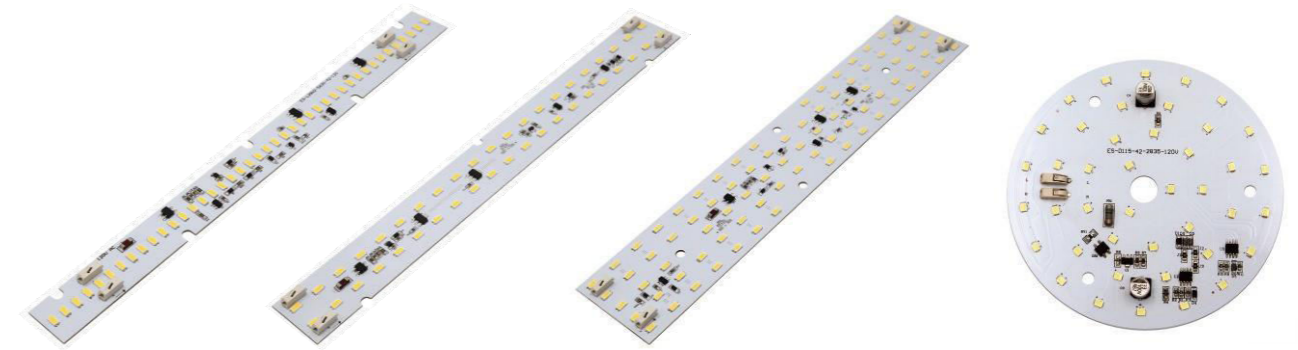

Model	Dimensions LxWxH(mm)	Luminous Flux (LM)	Power(W)	CRI	Light efficiency (LM/W)	PF
ES-LS28W2-42-5630-120	280x24x1.0	1000	10	80+	100	>0.95
ES-LS28W4-42-5630-120	280x32x1.0	1200	12	80+	100	>0.95
ES-LS28W6-84-5630-120	280x54x1.0	1500	15	80+	100	>0.95
ES-LS56W4-84-5630-120	560x32x1.0	2400	24	80+	100	>0.95
ES-D115-42-2835-120	D115x1.0	1350	15	80+	90	>0.9

## Common Series



Model	Dimensions LxWxH(mm)	Luminous Flux (LM)	Power(W)	CRI	Light efficiency (LM/W)	PF
ES-LS2525-3535-42-5630-120	304.8x20x1.0	800	8	80+	100	>0.95
ES-LS5035-84-5630-120	304.8x32x1.0	1200	12	80+	100	>0.95
ES-LS7535-84-5630-120	304.8x54x1.0	1500	15	80+	100	>0.95

## Zhaga Series

Product Features:

1. AC 120V/60Hz LED Module.
2. Triac dimmer.
3. Compliant with Zhaga Book7.
4. Offers best module efficacy up to 100Lm/W.

### ES-LS28W6-84-5630-120

1 2 3 4

- 1,Zhaga compliant
- 2,LED quantity
- 3,LED type
- 4,Input AC voltage

## Common Series

Product Features:

1. AC 120V/60Hz LED Module.
2. Triac dimmer.
3. Suitable for ESTAR aluminum profile.
4. Offers best module efficacy up to 100Lm/W.

### ES-LS5035-84-5630-120

1 2 3 4

- 1,ESTAR Aluminum Profile
- 2,LED quantity
- 3,LED type
- 4,Input AC voltage



LED Strip Light

LED Strip Light Accessory

Aluminum Profile

LED Linear Luminaire

LED Panel Light

LED Panel Light Accessory

LED Strip Light

LED Strip Light Accessory





















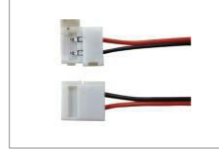



Aluminum Profile

LED Linear Luminaire

LED Panel Light

LED Panel Light Accessory

## LED Tape Light Connectors

	3.09.09.023(5mm 2PIN) 3.09.09.020(8mm 2PIN) 3.09.09.001(10mm 2PIN) 3.09.09.006(10mm 3PIN) 3.09.09.009(10mm 4PIN) 3.09.09.014(12mm 5PIN)		3.09.08.002(8MM) 3.09.08.023(10MM) 3.09.08.089(10MM 3PIN) 3.09.08.046(10MM 4PIN) 3.09.08.090(10MM 5PIN) 3.09.08.086(12MM 5PIN) 3.09.08.094(12MM 6PIN)		3.09.13.013(male) 3.09.13.014(female)
	3.09.09.002(10MM 2PIN) 3.09.09.007(10MM 3PIN)		3.09.10.133(female) 3.09.08.121(male)		3.09.06.001(male) 3.09.06.011(female)
	3.09.09.010(10mm 4PIN) 3.09.09.015(12mm 5PIN)		3.09.08.051(10MM 4PIN) 3.09.08.088(10MM 3PIN) 3.09.08.091(10MM 5PIN) 3.09.08.081(12MM 5PIN) 3.09.08.095(12MM 6PIN)		3.09.06.022(male) 3.09.06.026(female)
	3.09.09.003(10MM 2PIN) 3.09.09.008(10MM 3PIN)		3.09.08.005(8MM) 3.09.08.027(10MM)		3.09.18.023(male 5PIN) 3.09.18.024(female 5PIN) 3.09.18.031(male 4PIN) 3.09.18.032(female 4PIN) 3.09.02.023(male 3PIN) 3.09.18.042(female 3PIN) 3.09.18.022(male 2PIN) 3.09.18.021(female 2PIN)
	3.09.09.011(10mm 4PIN) 3.09.09.016(12mm 5PIN)		3.09.08.013(8MM) 3.09.08.037(10MM) 3.09.08.092(10MM 5PIN)		3.09.10.089(8MM) 3.09.10.090(10MM)
	4.03.01.044(10MM 2PIN)		3.09.08.061(10MM 4PIN) 3.09.08.087(10MM 3PIN) 3.09.08.074(12MM 5PIN) 3.09.08.096(12MM 6PIN)		3.09.10.040(male) 3.09.10.039(female)
	3.09.09.019(8MM 2PIN) 3.09.09.024(10MM 2PIN) 3.09.09.026(10MM 3PIN) 3.09.09.028(10MM 4PIN) 3.09.09.030(12MM 5PIN)		3.09.15.008(male 2PIN) 3.09.15.014(female 2PIN)		3.09.18.016(male) 3.09.18.015(female)
	3.09.09.018(8MM 2PIN) 3.09.09.025(10MM 2PIN) 3.09.09.027(10MM 3PIN) 3.09.09.029(10MM 4PIN) 3.09.09.031(12MM 5PIN)		3.09.15.001(male 4PIN) 3.09.15.002(female 4PIN)		3.09.08.127(L 2PIN 8mm) 3.09.08.128(T 2PIN 8mm) 3.09.08.129(+ 2PIN 8mm) 3.09.08.130(L 2PIN 10mm) 3.09.08.131(T 2PIN 10mm) 3.09.08.132(+ 2PIN 10mm) 3.09.08.133(L 4PIN 10mm) 3.09.08.135(T 4PIN 10mm) 3.09.08.136(+ 4PIN 10mm)

## 3M Tape



5604A  
3.04.04



9495LE  
3.04.02



9448A  
3.04.01



3.04.07

## LED Tape Light Controller

Dimmer



4.02.129  
12-24VDC  
3A\*3CH Max.9A  
108W/216W(12V/24V)

W+WW CCT Adjustable



4.02.128  
12-24VDC  
3A\*2CH Max.6A  
72W/144W(12V/24V)

RGB



4.02.127  
12-24VDC  
3A\*3CH Max.9A  
108W/216W(12V/24V)

RGBW



4.02.126  
5-24VDC  
5A\*4CH Max.20A  
240W/480W(12V/24V)

## LED Strip controller



4.02.123  
12-24VDC  
3A\*5CH Max.15A  
5CH\*(36-72)W

## Pixel Controller



4.02.124-1  
RF remote  
5-24VDC

## Line Voltage RGB Controller Mobile Control



4.02.140 Controller with EU Plug  
4.02.140-01 Controller with US Plug  
Input 110-120Vac/220-240Vac  
Output 90-110Vdc/180-220Vdc  
Max.Power 400W(110V)/800W(220V)

## LED Tape Light Amplifier

Dimmer amplifier



4.02.155  
12-24VDC  
12A\*1CH Max.12A  
0-144W,288W(12V/24V)

CCT Tunable amplifier  
RGB amplifier



4.02.152  
5-24VDC  
6A\*3CH Max.18A  
90W/216W/432W(5V/12V/24V)

RGB+W amplifier



4.02.156  
5-24VDC  
5A\*4CH Max.20A  
100W/240W/480W(5V/12V/24V)

## LED Power Supply

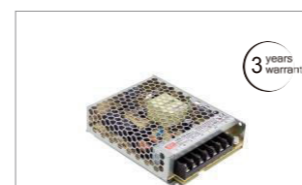

4.01.199  
LRS-100-12  
Non Waterproof  
12V/100W

3 years warranty



4.01.200  
LRS-100-24  
Non Waterproof  
24V/100W

3 years warranty



4.01.202  
RSP-320-12  
Non Waterproof  
12V/320W

2 years warranty



4.01.201  
RSP-320-24  
Non Waterproof  
24V/320W

2 years warranty

4.01.179  
LPV-100-12  
IP67/12V/100W

4.01.186  
LPV-100-24  
IP67/24V/100W

4.01.243  
LPV-60-24  
IP67/24V/60W

# 02 ALUMINUM PROFILE

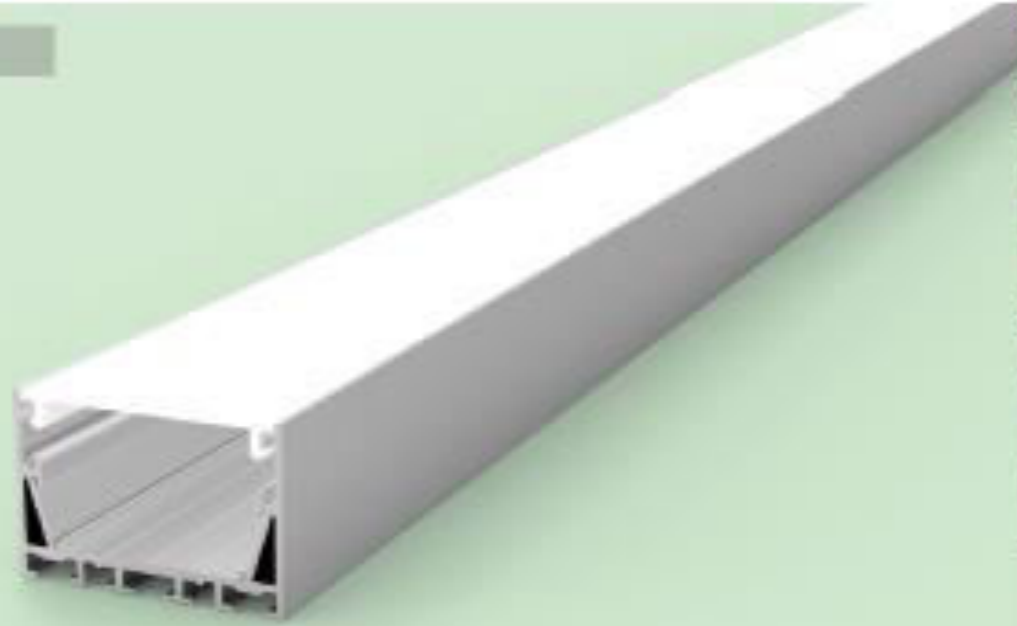

## Standard Color

Part Number	Color
Profile	 Less than 1265mm can spray white or black color
Install end cap	  

## Features

1. Use high quality aluminum as material.
2. Good heat dissipation for led strip and make the long lifetime for led strip.
3. Very helpful in keeping inventory because of the special design.
4. Standard color:silver(Standard length 2530mm),other colors in white,black and red are available but suggest less than 1265mm.

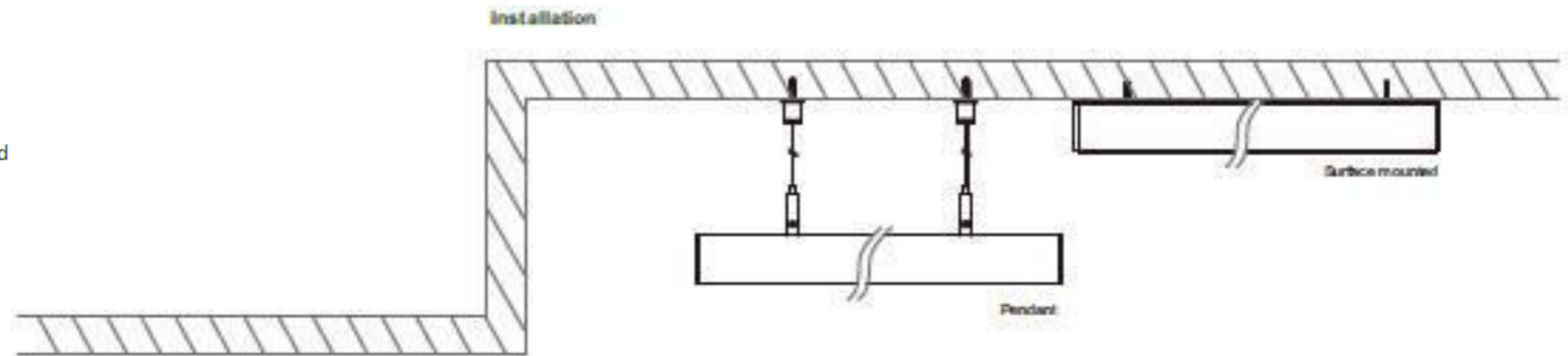

### Part Number:ES-LL035035



Unit:mm  
Standard Length:2530mm

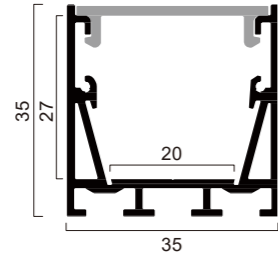

#### Standard

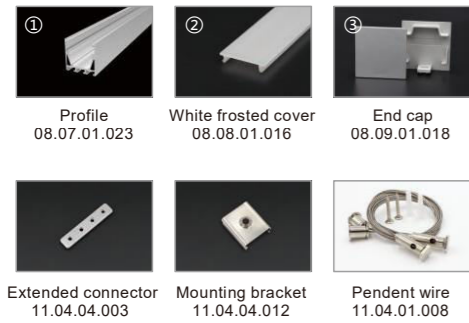

### Part Number:ES-LL075035



Unit:mm  
Standard Length:2530mm

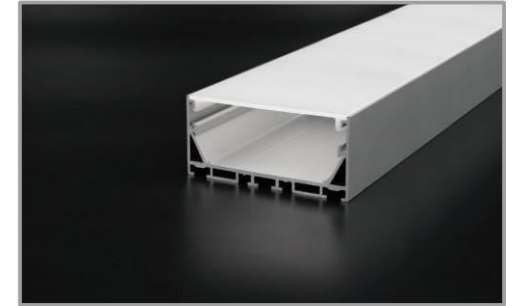
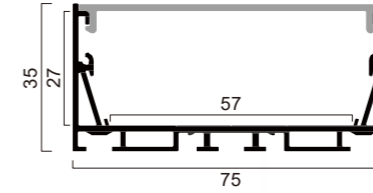

#### Standard

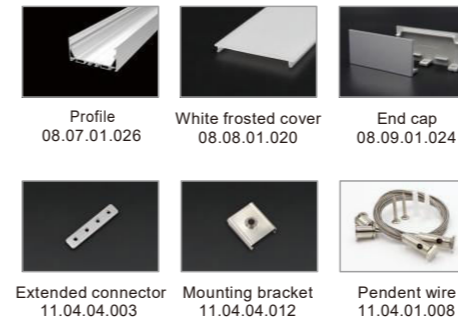

### Part Number:ES-LL050035



Unit:mm  
Standard Length:2530mm

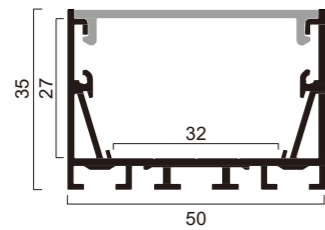

#### Standard

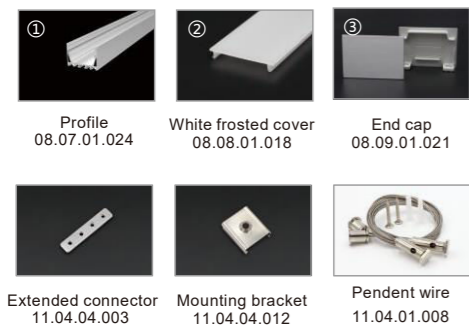

LED Strip Light

LED Strip Light Accessory

Aluminum Profile

LED Linear Luminaire

LED Panel Light

LED Panel Light Accessory

LED Strip Light

LED Strip Light Accessory

Aluminum Profile

LED Linear Luminaire

LED Panel Light

LED Panel Light Accessory

## Part Number:ES-LL025025



Unit:mm

Standard Length:2530mm

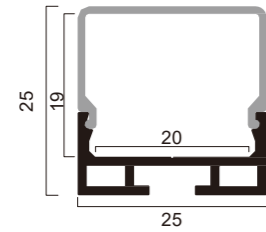

### Standard



## Part Number:ES-LL016016



Unit:mm

Standard Length:2020mm

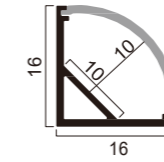

### Standard



## Part Number:ES-LL010015



Unit:mm

Standard Length:2020mm

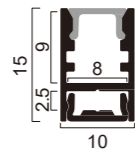

### Standard

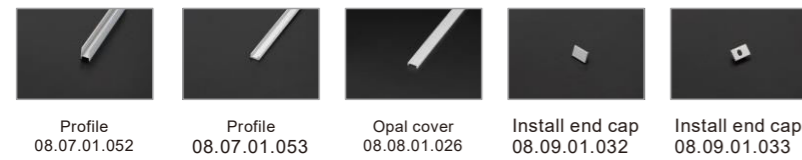

## Part Number:ES-LL030030



Unit:mm

Standard Length:2020mm

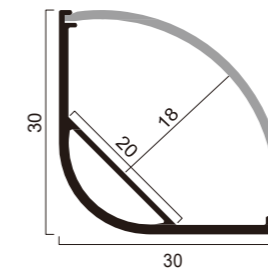

### Standard





Part Number:ES-LL017015



Unit:mm

Standard Length:2020mm

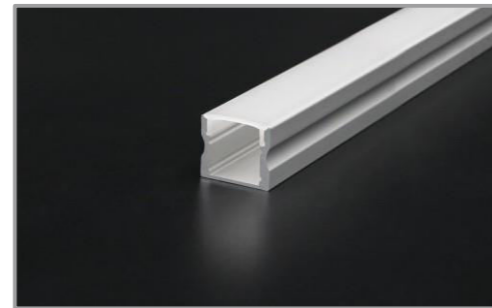
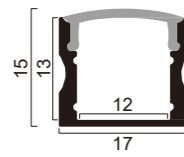

Standard

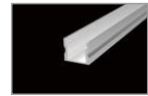

Profile  
08.07.01.010

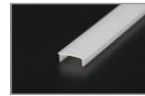

Opal cover  
08.08.01.005

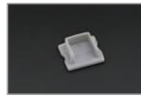

Install end cap  
08.09.01.005



Install end cap  
08.09.01.006

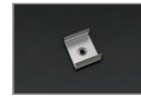

Mounting bracket  
11.04.04.009



Mounting bracket  
11.04.04.005

Part Number:ES-LL017009



Unit:mm

Standard Length:2020mm

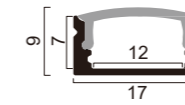

Standard



Profile  
08.07.01.008

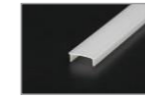

Opal cover  
08.08.01.005



Install end cap  
08.09.01.003



Install end cap  
08.09.01.004

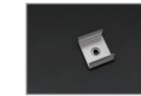

Mounting bracket  
11.04.04.009



Mounting bracket  
11.04.04.005

Part Number:ES-LL023015



Unit:mm

Standard Length:2020mm

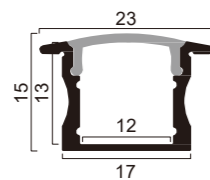

Standard



Profile  
08.07.01.013



Opal cover  
08.08.01.005



Install end cap  
08.09.01.011



Install end cap  
08.09.01.012



Mounting bracket  
11.04.04.009

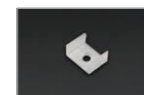

Mounting bracket  
11.04.04.005

Part Number:ES-LL023009



Unit:mm

Standard Length:2020mm

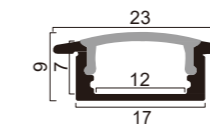

Standard



Profile  
08.07.01.003



Opal cover  
08.08.01.005



Install end cap  
08.09.01.007



Install end cap  
08.09.01.008

Part Number:ES-LL024011



Unit:mm

Standard Length:2020mm

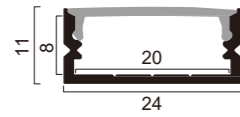

Standard



Part Number:ES-LL025019



Unit:mm

Standard Length:2020mm

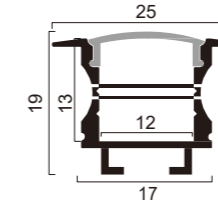

Standard

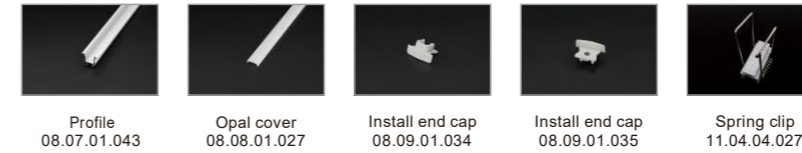

Part Number:ES-LL030011



Unit:mm

Standard Length:2020mm

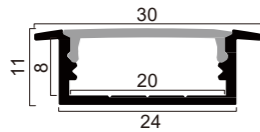

Standard

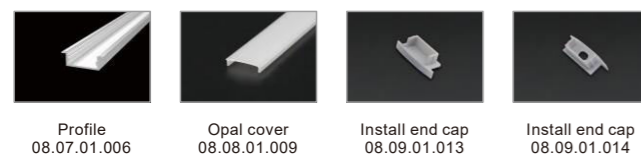

Part Number:ES-LL057011



Unit:mm

Standard Length:2020mm

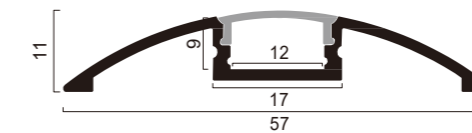

Standard

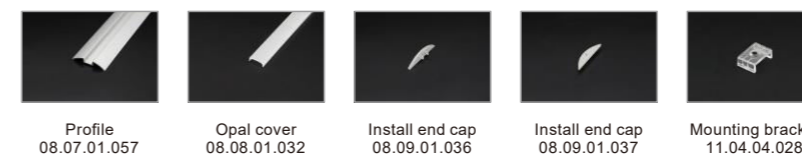

Part Number:ES-LL025046



Unit:mm

Standard Length:2020mm

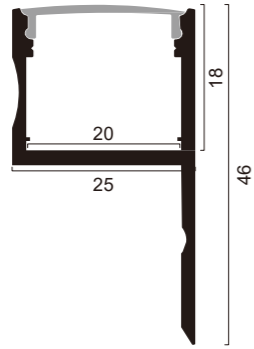

Standard



Profile 08.07.01.058, Opal cover 08.08.01.033, Install end cap 08.09.01.040, Install end cap 08.09.01.041

Part Number:ES-LL013006



Unit:mm

Standard Length:2020mm



Standard



Profile 08.07.01.042, Opal cover 08.08.01.025, Install end cap 08.09.01.030, Install end cap 08.09.01.031

Part Number:ES-LL064014



Unit:mm

Standard Length:2530mm

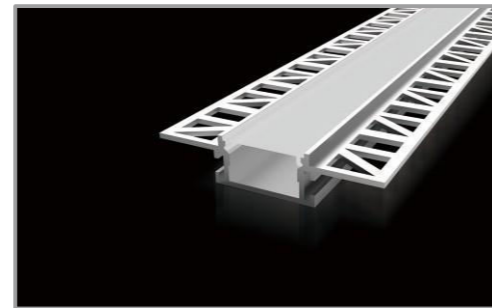
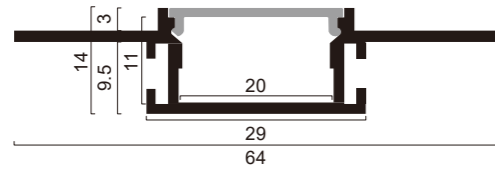

Standard



Profile 08.07.01.038, Opal cover 08.08.01.022, Install end cap 08.09.02.001, Install end cap 08.09.02.002, Extended connector 11.04.04.003, L connector 11.04.04.004

Part Number:ES-LL013012



Unit:mm

Standard Length:2020mm

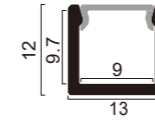

Standard



Profile 08.07.01.041, Opal cover 08.08.01.025, Install end cap 08.09.01.028, Install end cap 08.09.01.029

Part Number:ES-LL020020



Unit:mm

Standard Length:2500mm

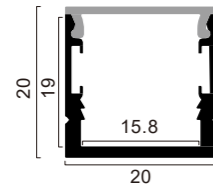

Standard

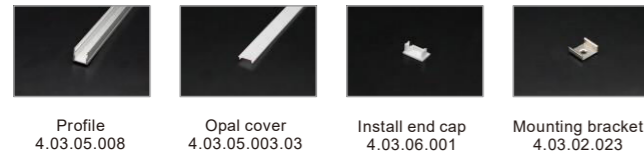

Part Number:ES-LL019008



Unit:mm

Standard Length:2500mm

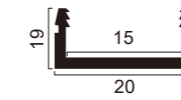

Standard

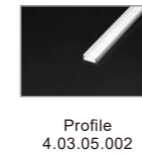

Part Number:ES-LL020030



Unit:mm

Standard Length:2500mm

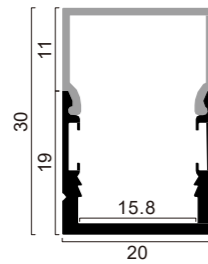

Standard

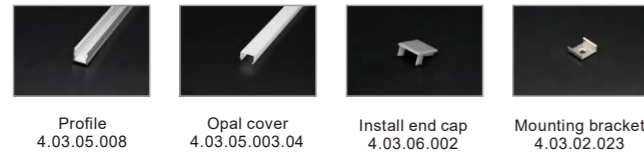

Part Number:ES-LL023021



Unit:mm

Standard Length:2500mm

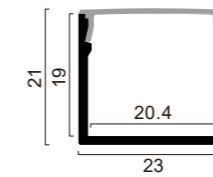

Standard

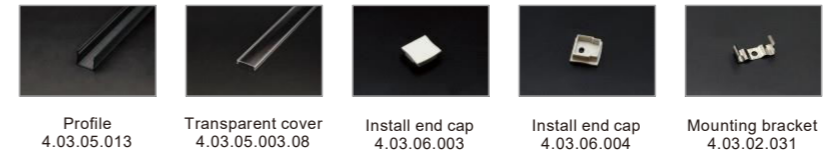

# LED LINEAR LUMINAIRE

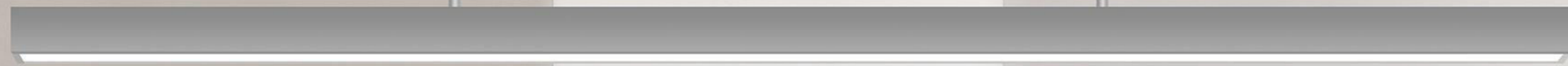

## Applications

Indoor-offices, office buildings, business centers, shopping malls, supermarkets, houses, hotels, architectural lighting and general lighting

## Features

1. Be made up of aluminum alloy, LED Linear Luminaire has clear lines, simple structure and elegant appearance, which is durable, corrosion resistant and easy to install.
2. The hanging circle tube is adjustable and only 2 hanging circle tubes are needed for a 8-foot long LED linear Luminaire. And the hollow circle tube can allow the cable with maximum diameter as 7mm getting through, which makes the installation more simple and convenient. The appearance looks more concise and good-looking, unlike the traditional lamps with many cables on the lamp and looks in a mess.
3. Break through the limitation of the traditional lighting system and realize "three kinds of freedom", which is the design freedom of the human, installation freedom of the products and also the application freedom of the environments.
4. Built-in power supply series or external power supply series can be turned easily by adding Aluminum extended edges.

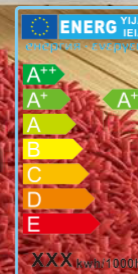

# ES-LLPM035056PWF-ID4F

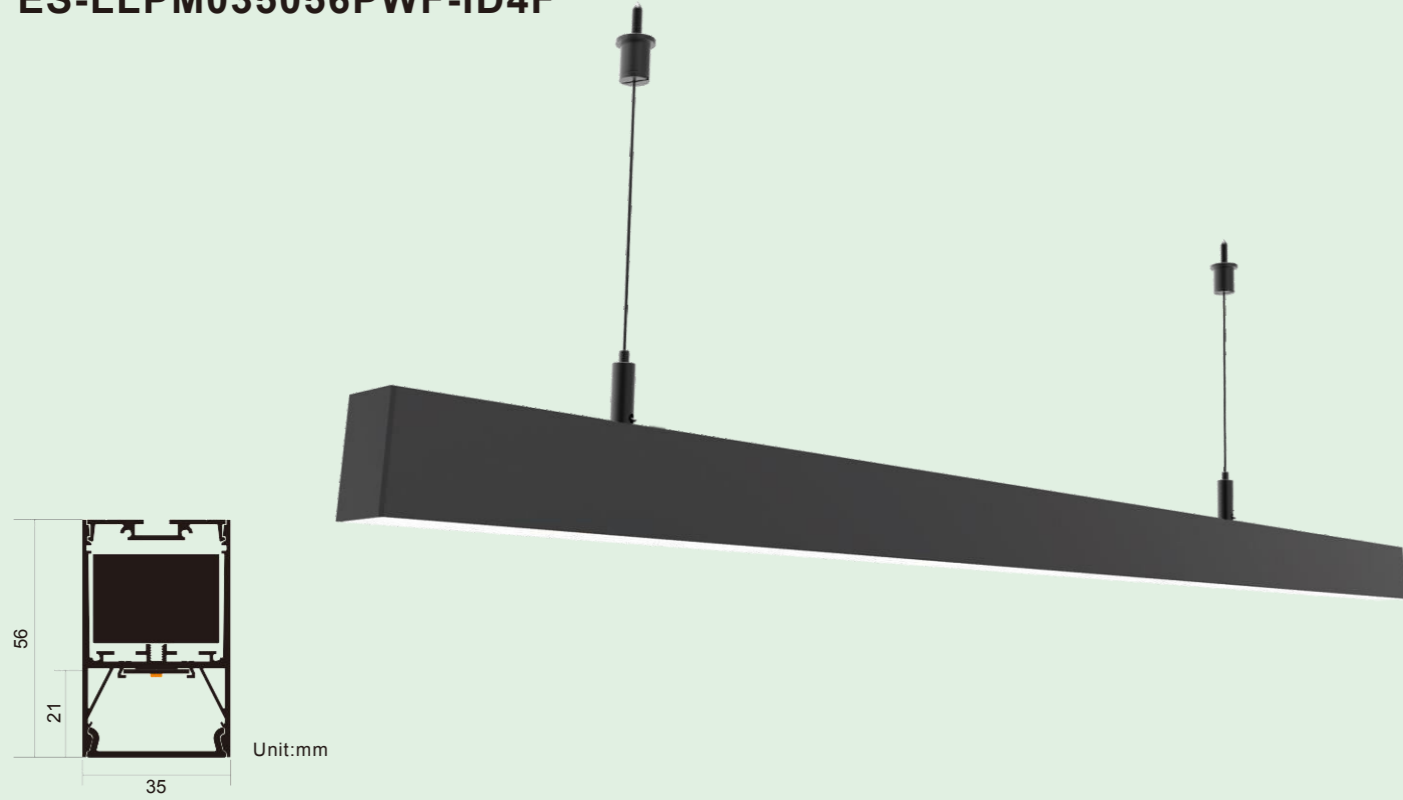

# ES-LLPM050060PWF-ID4F



Model	Length (Feet)	Color Temp.	LED Type	LED Qty (pcs)	CRI(Ra)	Luminous (±10%)	Power (±10%)	Input Voltage	Dimming Optional	Pre-wired
ES-LLPM035056 PWF-ID4F	2'	2800-3200K	5630	96	80+	1100LM	15W	50/60Hz	0-10V Dim	5wire, 18AWG L,N,G, DIM+,DIM-
		3800-4300K				1200LM			0-10V Dim	
	4'	2800-3200K	5630	192	80+	2200LM	30W	AC 110-277V 50/60Hz	0-10V Dim	3wire, 18AWG L,N,G
		3800-4300K				2400LM			0-10V Dim	
		5000-5500K						0-10V Dim		



Model	Length (Feet)	Color Temp.	LED Type	LED Qty (pcs)	CRI(Ra)	Luminous (±10%)	Power (±10%)	Input Voltage	Dimming Optional	Pre-wired
ES-LLPM050060 PWF-ID4F	2'	2800-3200K	5630	144	80+	1600LM	19W	50/60Hz	0-10V Dim	5wire, 18AWG L,N,G, DIM+,DIM-
		3800-4300K				1700LM			0-10V Dim	
	4'	2800-3200K	5630	288	80+	1700LM	36W	AC 110-277V 50/60Hz	0-10V Dim	5wire, 18AWG L,N,G, DIM+,DIM-
		3800-4300K				3400LM			0-10V Dim	
		5000-5500K						1-10V Dim		

ILLUMINATION CURVE AND LUMINOUS INTENSITY DISTRIBUTION DIAGRAM 4000K(4 FEET)

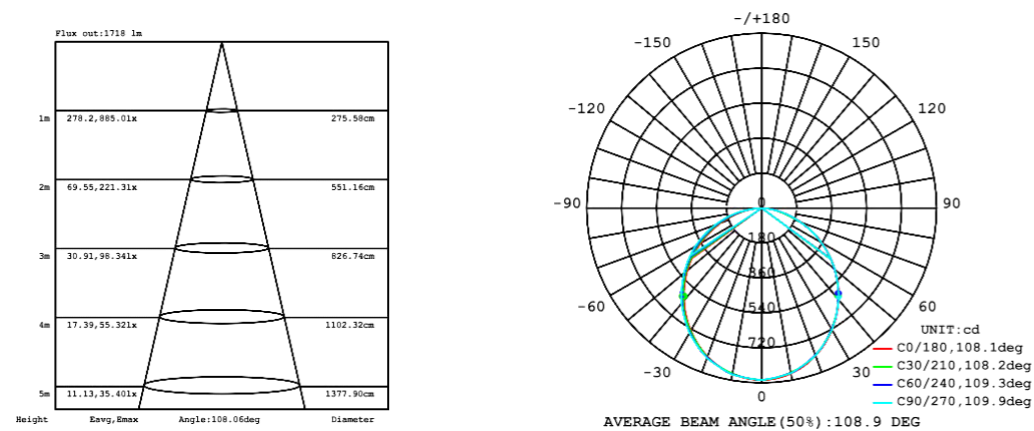

ILLUMINATION CURVE AND LUMINOUS INTENSITY DISTRIBUTION DIAGRAM 4000K(4 FEET)

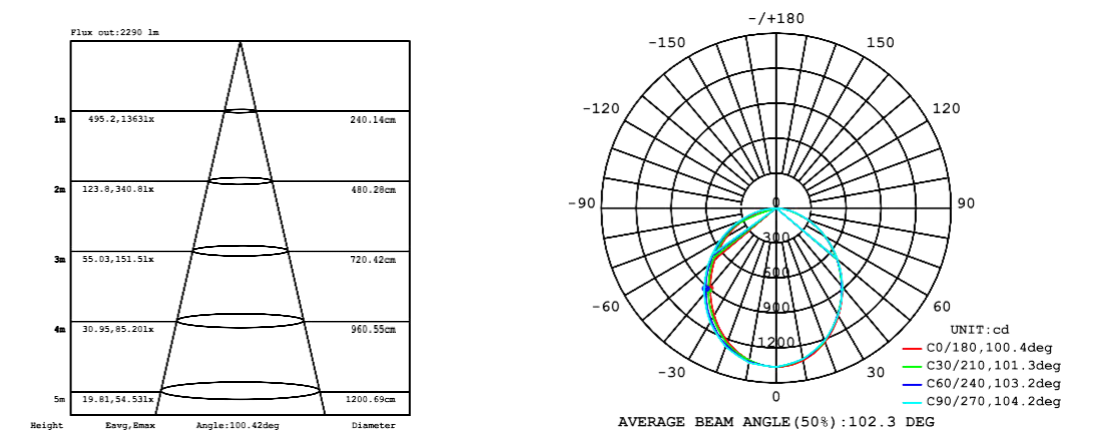

LED Strip Light

LED Strip Light Accessory

Aluminum Profile

LED Linear Luminaire

LED Panel Light

LED Panel Light Accessory

LED Strip Light

LED Strip Light Accessory

Aluminum Profile

LED Linear Luminaire

LED Panel Light

LED Panel Light Accessory

# Built-In Power Supply Series

## Double-Sided Series



### Product Features:

1. Be made up of aluminum alloy, LED Linear Luminaire has clear lines, simple structure and elegant appearance, which is durable, corrosion resistant and easy to install.
2. Using plastic parts to lock the strip board on the aluminum profile instead of drilling and playing screw to fix them. It creatively solves the problem that LED strip may fall off when the glue is not sticky anymore.
3. The built-in power supply models, Aluminum extended edges and Aluminum profiles can choose different colors according to different application environments. The appearance is more fashionable and good-looking.
4. The hanging circle tube is adjustable and only 2 hanging circle tubes are needed for a 8-foot long LED linear luminaire. And the hollow circle tube can allow the cable with maximum diameter as 7mm getting through, which makes the installation more simple and convenient. The appearance looks more concise and good-looking, unlike the traditional lamps with many cables on the lamp and looks in a mess.



LED Strip Light

LED Strip Light Accessory

Aluminum Profile

LED Linear Luminaire

LED Panel Light

LED Panel Light Accessory

LED Strip Light

LED Strip Light Accessory

Aluminum Profile

LED Linear Luminaire

LED Panel Light

LED Panel Light Accessory

# ES-LLPM035056PWF-IUD4F

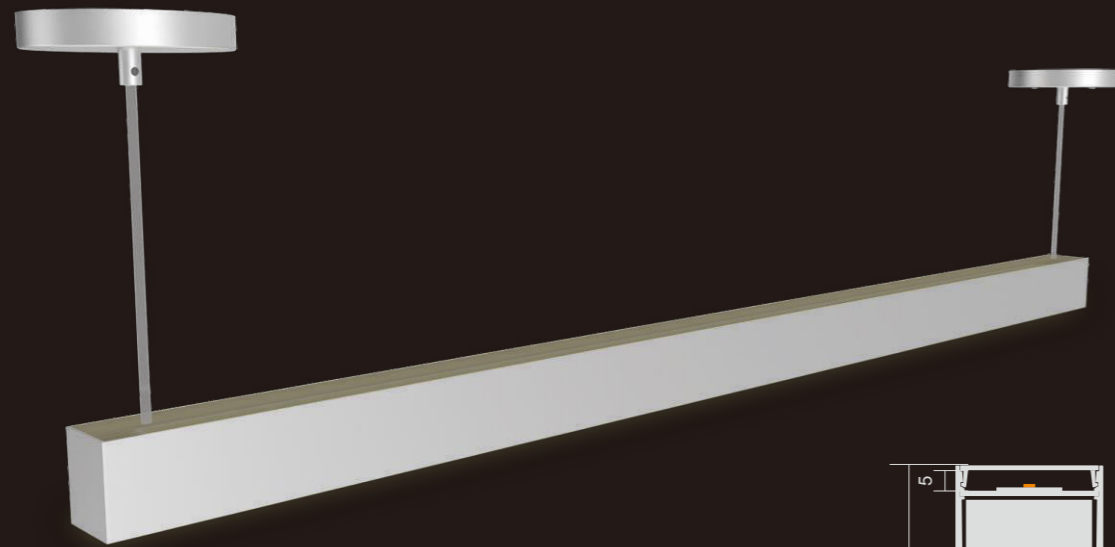

Double-Sided  
(up 40%,down 60%)



Unit:mm

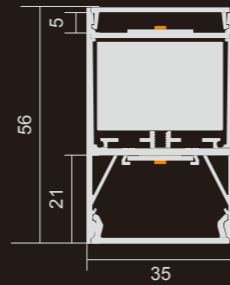

# ES-LLPM050060PWF-IUD4F

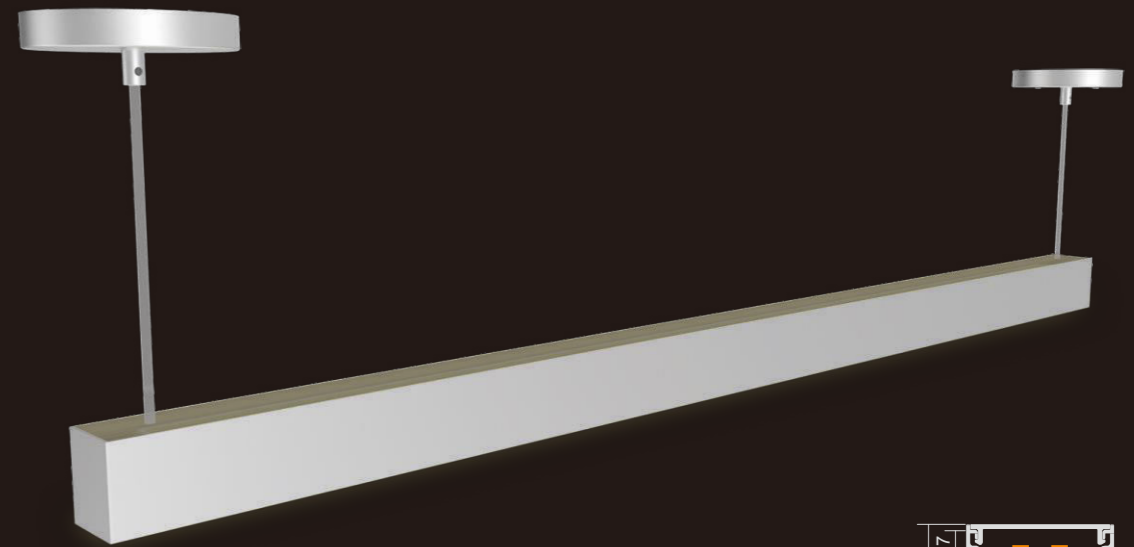

Double-Sided  
(up 40%,down 60%)



Unit:mm

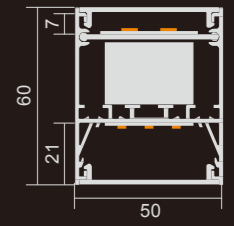

Model	Length (Feet)	Color Temp.	LED Type	LED Qty (pcs)	CRI(Ra)	Luminous (±10%)	Power (±10%)	Input Voltage	Dimming Optional	Pre-wired
ES-LLPM035056 PWF-IUD4F	2'	2800-3200K	5630	48(UP)	80+	1575LM	21W	AC 110-277V 50/60Hz	0-10V Dim	5wire,18AWG L,N,G, DIM+,DIM-
		3800-4300K		96(Down)		1785LM			0-10V Dim	
	4'	2800-3200K	5630	96(UP)	80+	3187LM	42W	AC 110-277V 50/60Hz	0-10V Dim	3wire,18AWG L,N,G
		3800-4300K		192(Down)		3612LM			0-10V Dim	
		5000-5500K				3612LM			0-10V Dim	



Model	Length (Feet)	Color Temp.	LED Type	LED Qty (pcs)	CRI(Ra)	Luminous (±10%)	Power (±10%)	Input Voltage	Dimming Optional	Pre-wired
ES-LLPM050060 PWF-IUD4F	2'	2800-3200K	5630	72(UP)	80+	2550LM	30W	AC 110-277V 50/60Hz	0-10V Dim	5wire,18AWG L,N,G, DIM+,DIM-
		3800-4300K		144(Down)		2850LM			0-10V Dim	
	4'	2800-3200K	5630	144(UP)	80+	5100LM	60W	AC 110-277V 50/60Hz	0-10V Dim	5wire,18AWG L,N,G, DIM+,DIM-
		3800-4300K		288(Down)		5700LM			0-10V Dim	
		5000-5500K				5700LM			0-10V Dim	

Illumination Curve and Luminous Intensity Distribution Diagram 4000K(4 Feet)

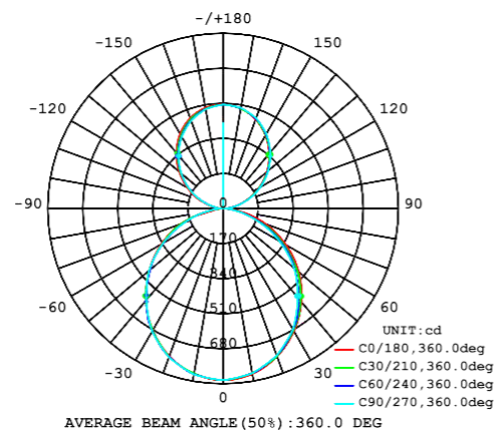
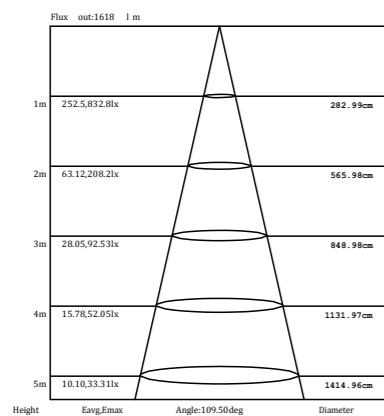

Illumination Curve and Luminous Intensity Distribution Diagram 4000K(4 Feet)

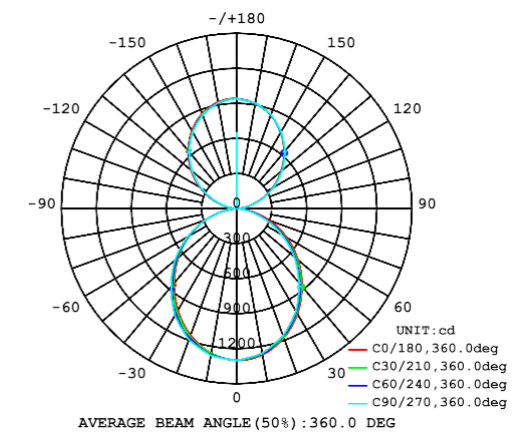
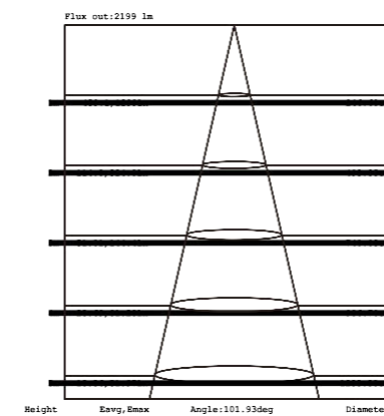



# LED PANEL LIGHT

## Applications

Hotels  
Conference/Meeting rooms  
Factories and offices  
Commercial purposes  
Residential / Institution buildings  
Schools, colleges, universities and hospitals  
Places which needs energy saving and high color-rendering index lighting

## Features

1. CE approved.
2. High light efficiency 120LM/W and 135LM/W, 5 years warranty.
3. Constant current driver with short-circuit and open-circuit protection.
4. Recessed mounted and ceiling or wall surface-mounted is optional.
5. Widely use and environment friendly without IR and UV radiation.
6. UP to 80% energy saving compared to standard CFL.
7. Long lifetime of 40,000 hours.



**Part Number:ES-PL6262EA5-40W**

Power **40W** CRI **Ra 80+**  
Ra 90+(available)

Size **620\*620MM** Thickness **10MM**

Super efficiency **>120LM/W**  
(natural white) UGR<19(available)

Input **200-240VAC** Housing **Aluminum**  
(white paint/silver color)

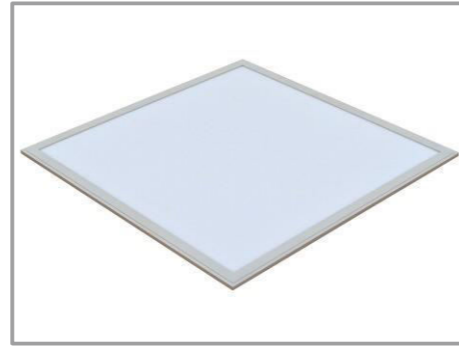

ES-PL6262EA5-40W Model	Light color	Color temp.	4600LM Lumen	115LM/W lm/w
ES-PL6262EA5-40W	warm white	3000K	4800LM	120LM/W
ES-PL6262EA5-40W	natural white	5000K 4000K	4800LM	120LM/W
ES-PL6262EA5-40W	natural white		4800LM	120LM/W
	white	6000K		

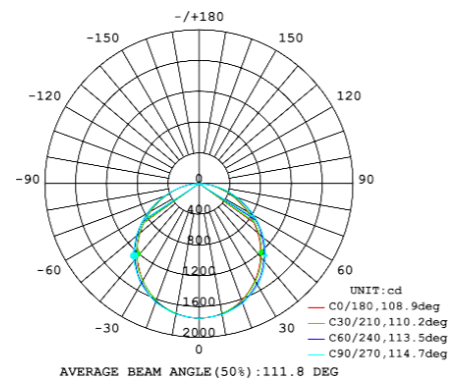
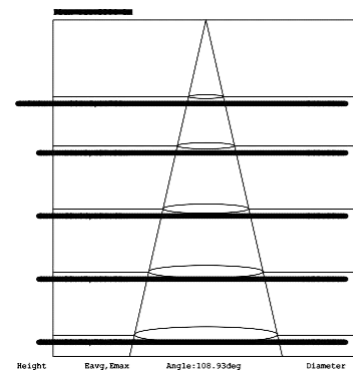

**Part Number:ES-PL6262EA5-28W**

Power **28W** CRI **Ra 80+**  
Ra 90+(available)

Size **620\*620MM** Thickness **10MM**

Super efficiency **>135LM/W**  
(natural white) UGR<19

Input **200-240VAC** Housing **Aluminum**  
(white paint/silver color)

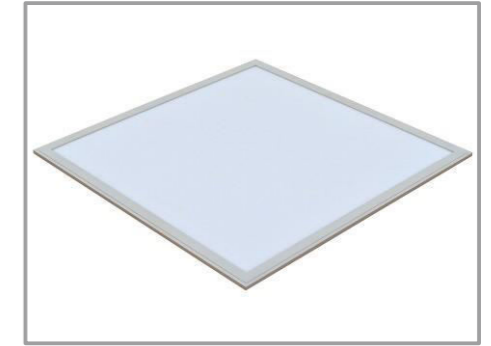

ES-PL6262EA5-28W Model	Light color	Color temp.	3640LM Lumen	130LM/W lm/w
ES-PL6262EA5-28W	warm white	3000K	3780LM	135LM/W
ES-PL6262EA5-28W	natural white	5000K 4000K	3780LM	135LM/W
ES-PL6262EA5-28W	natural white		3780LM	135LM/W
	white	6000K		

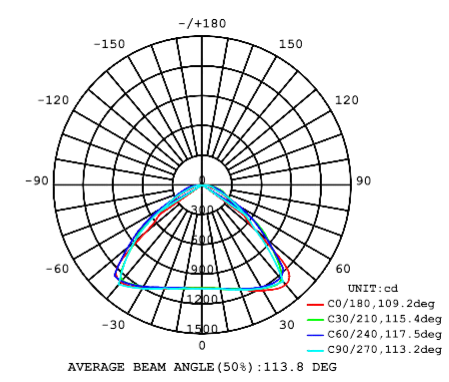
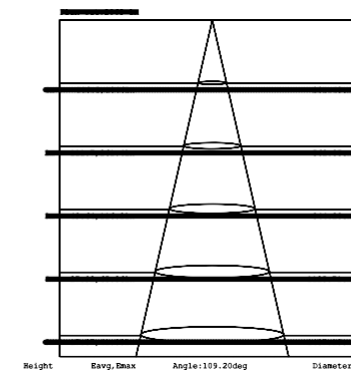

**Part Number:ES-PL6060EA5-40W**

Power  
**40W**

CRI  
**Ra 80+**  
Ra 90+(available)

Size  
**595\*595MM**

Thickness  
**10MM**

Light efficiency  
**>120LM/W**  
(natural white)

UGR<19(available)

Input  
**200-240VAC**

Housing  
**Aluminum**  
(white paint/silver color)

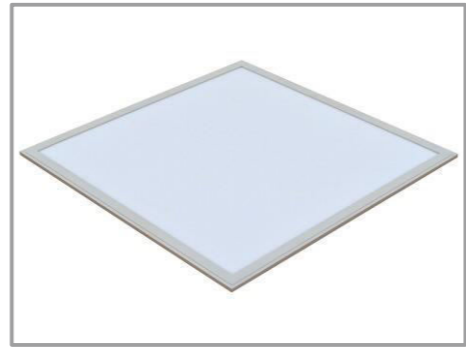

Model	Light color	Color temp.	Lumen	LM/W
ES-PL6060EA5-40W	warm white	3000K	4600LM	115LM/W
ES-PL6060EA5-40W	natural white	4000K	4800LM	120LM/W
ES-PL6060EA5-40W	natural white	5000K	4800LM	120LM/W
ES-PL6060EA5-40W	white	6000K	4800LM	120LM/W

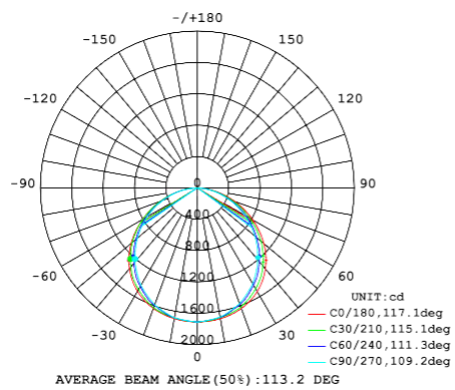
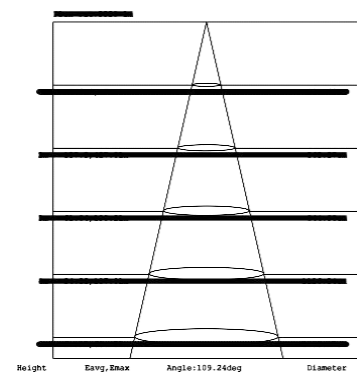

**Part Number:ES-PL6060EA5-28W**

Power  
**28W**

CRI  
**Ra 80+**  
Ra 90+(available)

Size  
**595\*595MM**

Thickness  
**10MM**

Super efficiency  
**>135LM/W**  
(natural white)

UGR<19

Input  
**200-240VAC**

Housing  
**Aluminum**  
(white paint/silver color)

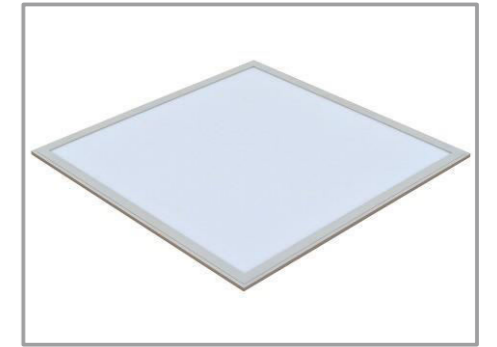

Model	Light color	Color temp.	Lumen	LM/W
ES-PL6060EA5-28W	warm white	3000K	3640LM	130LM/W
ES-PL6060EA5-28W	natural white	4000K	3780LM	135LM/W
ES-PL6060EA5-28W	natural white	5000K	3780LM	135LM/W
ES-PL6060EA5-28W	white	6000K	3780LM	135LM/W

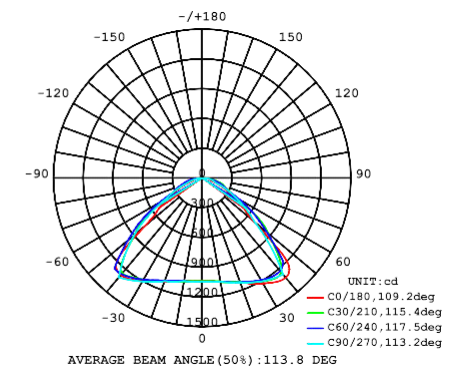
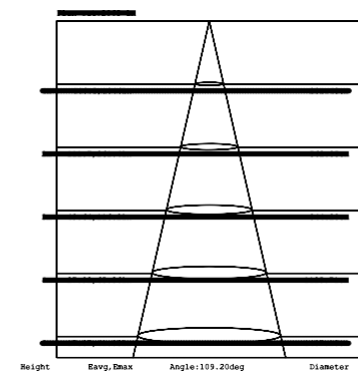

## Part Number:ES-PL1230EA5-40W

Power  
**40W**

CRI  
**Ra 80+**  
Ra 90+(available)

Size  
**1195\*295MM**

Thickness  
**10MM**

Light efficiency  
**>120LM/W**  
(natural white)

UGR<19(available)

Input  
**200-240VAC**

Housing  
**Aluminum**  
(white paint/silver color)

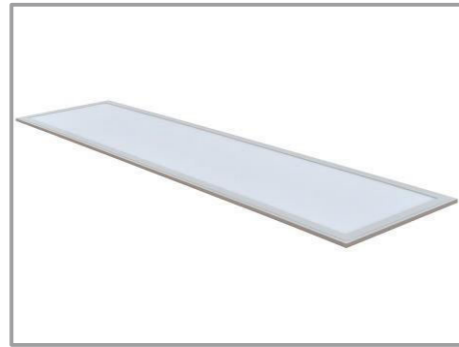

Model	Light color	Color temp.	Lumen	LM/W
ES-PL1230EA5-40W	warm white	3000K	4600LM	115LM/W
ES-PL1230EA5-40W	natural white	4000K	4800LM	120LM/W
ES-PL1230EA5-40W	natural white	5000K	4800LM	120LM/W
ES-PL1230EA5-40W	white	6000K	4800LM	120LM/W

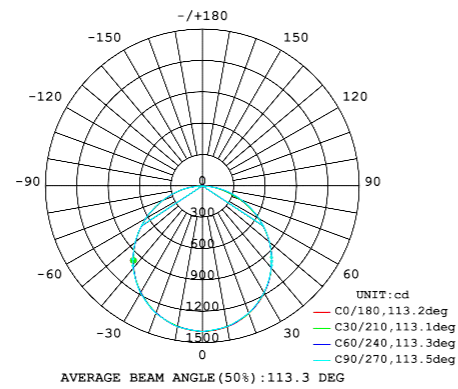
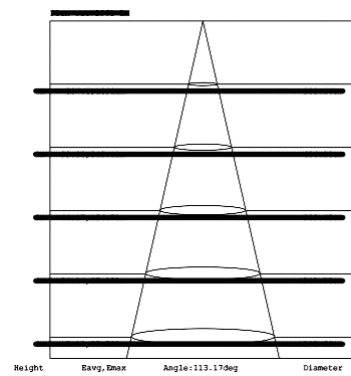

## Part Number:ES-PL1230EA5-28W

Power  
**28W**

CRI  
**Ra 80+**  
Ra 90+(available)

Size  
**1195\*295MM**

Thickness  
**10MM**

Light efficiency  
**>135LM/W**  
(natural white)

UGR<19

Input  
**200-240VAC**

Housing  
**Aluminum**  
(white paint/silver color)

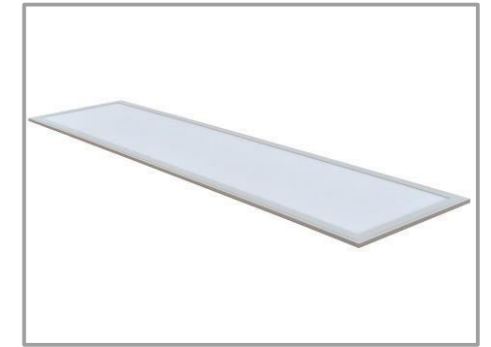

Model	Light color	Color temp.	Lumen	LM/W
ES-PL1230EA5-28W	warm white	3000K	3640LM	130LM/W
ES-PL1230EA5-28W	natural white	4000K	3780LM	135LM/W
ES-PL1230EA5-28W	natural white	5000K	3780LM	135LM/W
ES-PL1230EA5-28W	white	6000K	3780LM	135LM/W

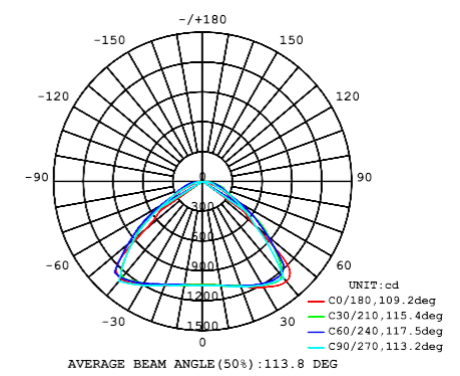
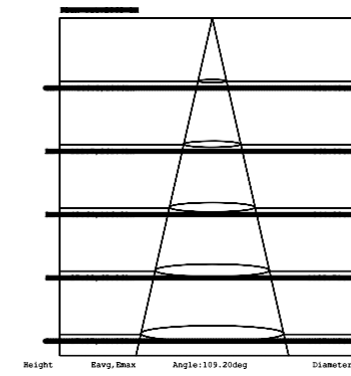

## Part Number:ES-PL1230TDXY-60W

Power  
**60W**

CRI  
**Ra 80+**  
Ra 90+(available)

Size  
**1195\*295MM**

Thickness  
**11MM**

Light efficiency  
**>110LM/W**  
(natural white)

**UGR<19**

Input  
**100-277VAC**

 **Double-Sided LED Panel**  
(up 50%,down 50%)

Housing  
**Aluminum**  
(white paint/silver color)

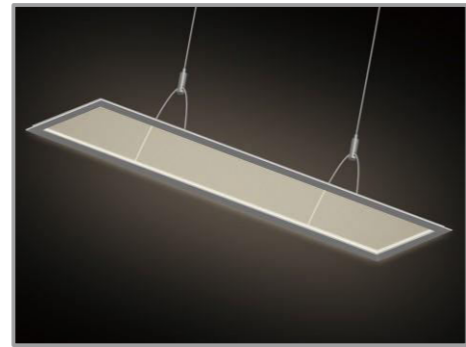

Model	Light color	Color temp.	Lumen	LM/W
ES-PL1230TDC5-60W	warm white	3000K	6000LM	100LM/W
ES-PL1230TDC5-60W	natural white	4000K	6600LM	110LM/W
ES-PL1230TDC5-60W	natural white	5000K	6900LM	115LM/W
ES-PL1230TDC5-60W	white	6000K	6900LM	115LM/W

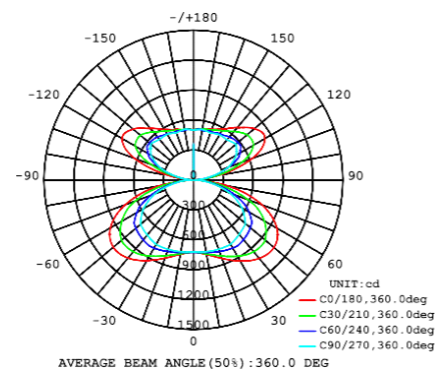
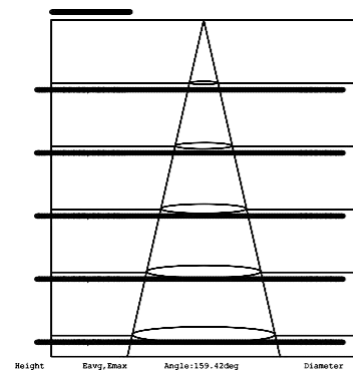

## Part Number:ES-PL1225TDXY-50W

Power  
**50W**

CRI  
**Ra 80+**  
Ra 90+(available)

Size  
**1200\*251MM**

Thickness  
**15MM**

Light efficiency  
**>80LM/W**  
(natural white)

**UGR<19**

Input  
**100-277VAC**

 **Double-Sided LED Panel**  
(up 50%,down 50%)

Housing  
**Aluminum**  
(white paint/silver color)

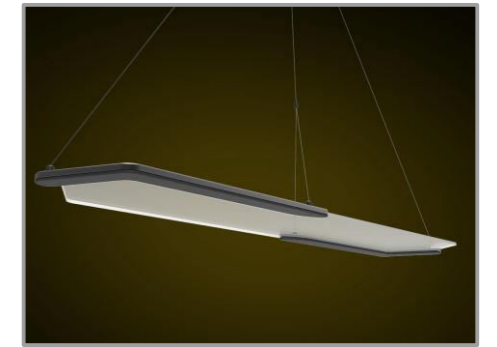

Model	Light color	Color temp.	Lumen	LM/W
ES-PL1225TDEC5-50W	warm white	3000K	3500LM	70LM/W
ES-PL1225TDEC5-50W	natural white	4000K	3750LM	75LM/W
ES-PL1225TDEC5-50W	natural white	5000K	4000LM	80LM/W
ES-PL1225TDEC5-50W	white	6000K	4000LM	80LM/W

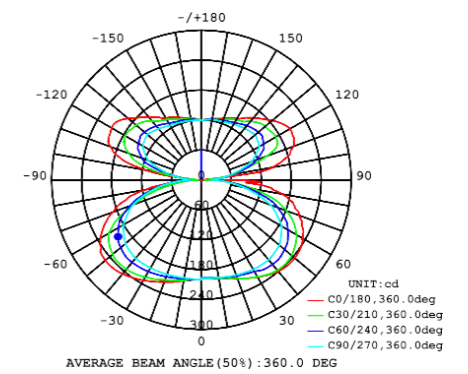
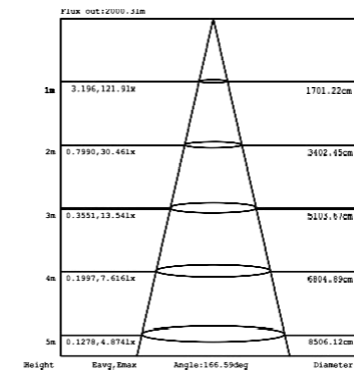

## Part Number: ES-PL3030EA5-28W

Power  
**28W**

CRI  
**Ra 80+**  
Ra 90+(available)

Size  
**295\*295MM**

Thickness  
**10MM**

Light efficiency  
**>85LM/W**  
(natural white)

Housing  
**Aluminum**  
(white paint/silver color)

Input  
**200-240VAC**

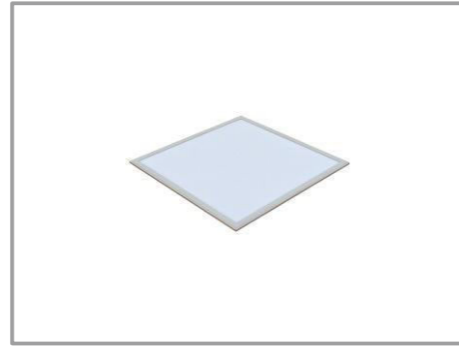

Model	Light color	Color temp.	Lumen	LM/W
ES-PL3030EA5-28W	warm white 3000K	■	2240LM	
ES-PL3030EA5-28W	natural white	■	2380LM	
ES-PL3030EA5-28W	natural white	■	2380LM	
			2380LM	80LM/W
ES-PL3030EA5-28W	white	□	6000K	85LM/W
				85LM/W
				85LM/W

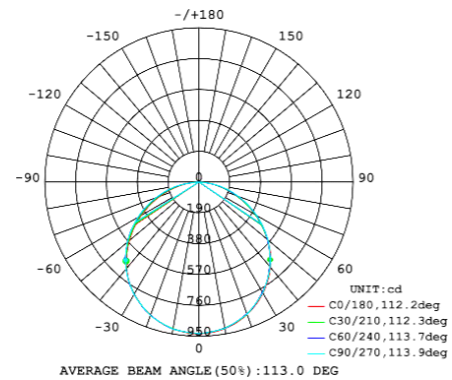
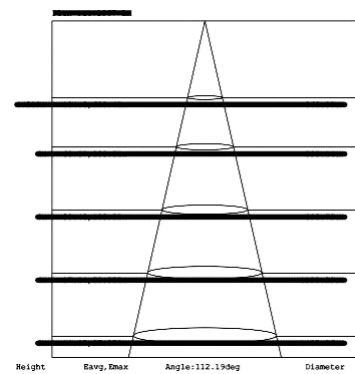

## Part Number: ES-PL1260EA5-60W

Power  
**60W**

CRI  
**Ra 80+**  
Ra 90+(available)

Size  
**1195\*595MM**

Thickness  
**11MM**

Light efficiency  
**>110LM/W**  
(natural white)

Housing  
**Aluminum**  
(white paint/silver color)

Input  
**200-240VAC**

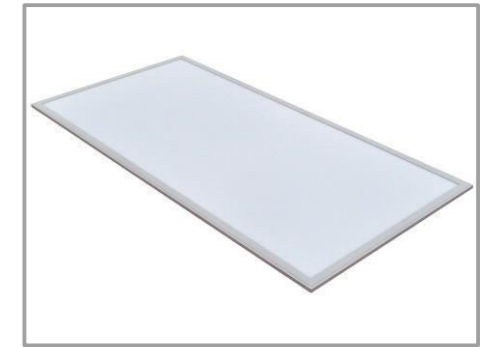

Model	Light color	Color temp.	Lumen	LM/W
ES-PL1260EA5-60W	warm white	■	3000K	6600LM
ES-PL1260EA5-60W	natural white	■	4000K	6600LM
ES-PL1260EA5-60W	natural white	■	5000K	6600LM
ES-PL1260EA5-60W	white	□	6000K	110LM/W

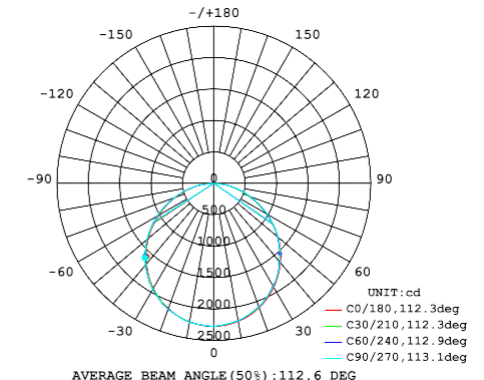
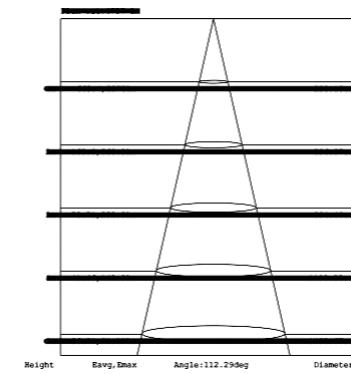

# CE LED Panel Light

Round



Part Number: ES-PLD850EXY-80W

Power **80W**      CRI **Ra 80+**  
Ra 90+(available)

Diameter **850MM**      Thickness **20MM**

Light efficiency **>95LM/W**  
(natural white)

Input **100-277VAC**      Housing **Aluminum**  
(white paint/silver color)

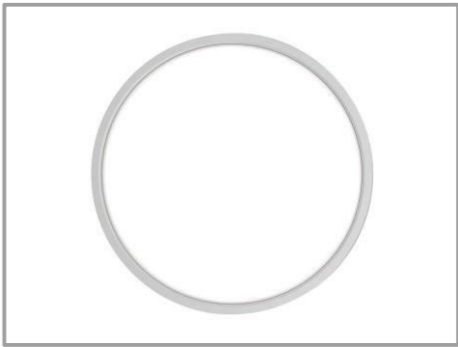

Model	Light color	Color temp.	Lumen	LM/W
		3000K	6650LM	85LM/W
ES-PLD850EA2-80W	warm white	4000K	7600LM	95LM/W
ES-PLD850EA2-80W	natural white	5000K	7600LM	95LM/W
ES-PLD850EA2-80W	natural white	6000K	7600LM	95LM/W
ES-PLD850EA2-80W	white			

Product Features:

- 1. CE approved
- 2. High brightness LED inside of panel
- 3. Safe and easy to install, no warm up time required, no noise and no flickering
- 4. Widely use and environment friendly without IR and UV radiation
- 5. Constant current driver with short-circuit and open-circuit protection
- 6. Recessed mounted
- 7. Up to 80% energy saving compared to standard CFL
- 8. Long lifetime of 40,000 hours

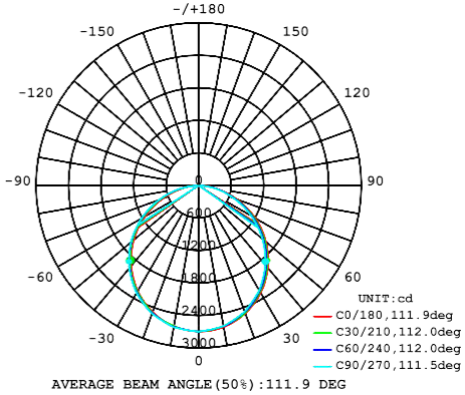
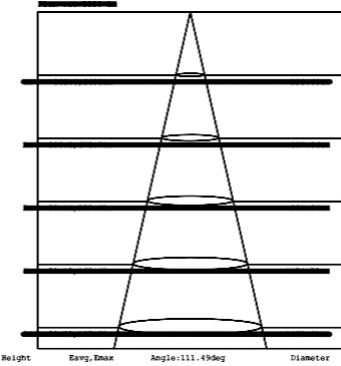
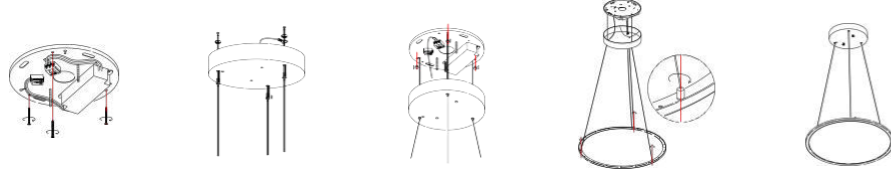

**Part Number:ES-PLD850TDXY-80W**

Power **80W** CRI **Ra 80+**  
Ra 90+(available)

Diameter **850MM** Thickness **20MM**

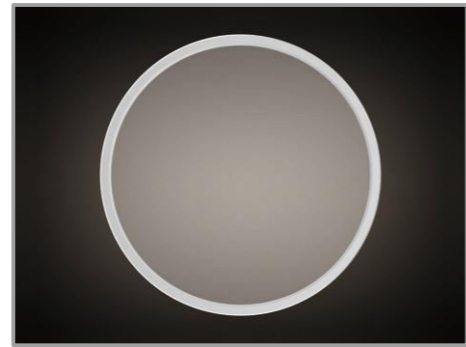

Light efficiency **>95LM/W**  
(natural white) **UGR<19**

Input **100-277VAC**  **Double-Sided LED Panel**  
(up 50%,down 50%)

Housing **Aluminum**  
(white paint/silver color)



Model	Light color	Color temp.	Lumen	LM/W
ES-PLD850TDC2-80W	warm white	3000K	6500LM	85LM/W
ES-PLD850TDC2-80W	natural white	4000K	7600LM	95LM/W
ES-PLD850TDC2-80W	natural white	5000K	7600LM	95LM/W
ES-PLD850TDC2-80W	white	6000K	7600LM	95LM/W

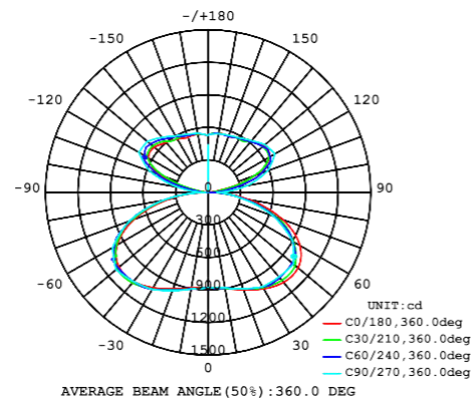
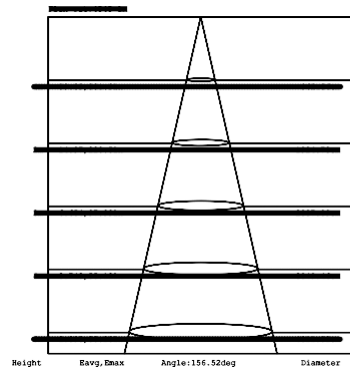

**Part Number:ES-PLD580EXY-52W**

Power **52W** CRI **Ra 80+**  
Ra 90+(available)

Diameter **580MM** Thickness **13MM**

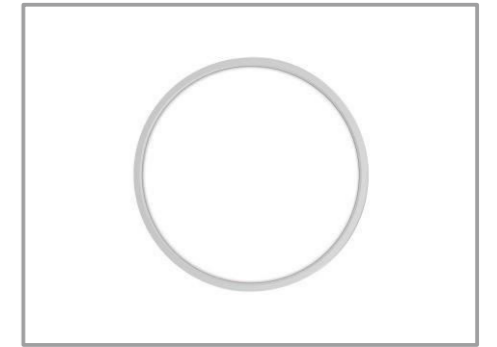

Light efficiency **>100LM/W**  
(natural white) **UGR<19**(available)

Input **100-277VAC**  **Double-Sided LED Panel**  
(up 50%,down 50%)

Housing **Aluminum**  
(white paint/silver color)



Model	Light color	Color temp.	Lumen	LM/W
ES-PLD580EA2-52W	warm white	3000K	4680LM	90LM/W
ES-PLD580EA2-52W	natural white	4000K	5200LM	100LM/W
ES-PLD580EA2-52W	natural white	5000K	5200LM	100LM/W
ES-PLD580EA2-52W	white	6000K	5200LM	100LM/W

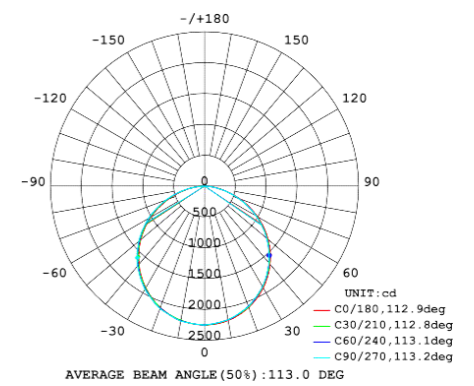
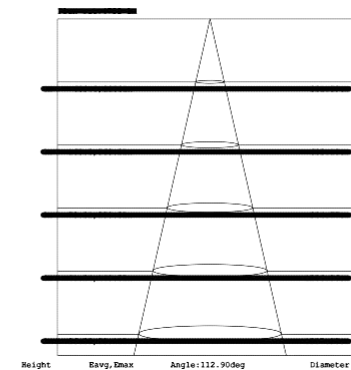



## Part Number:ES-PLD580TDXY-60W

Power  
**60W**

CRI  
**Ra 80+**  
Ra 90+(available)

Diameter  
**580MM**

Thickness  
**13MM**

Light efficiency  
**>110LM/W**  
(natural white)





**UGR<19**

Input  
**100-277VAC**

 **Double-Sided LED Panel**  
(up 50%,down 50%)

Housing  
**Aluminum**  
(white paint/silver color)



Model	Light color	Color temp.	Lumen	LM/W
ES-PLD580TDC2-60W	warm white	 3000K	5400LM	90LM/W
ES-PLD580TDC2-60W		 4000K	6600LM	110LM/W
ES-PLD580TDC2-60W	natural white	 5000K	6900LM	115LM/W
ES-PLD580TDC2-60W		 6000K	6900LM	115LM/W
	white	 6000K		

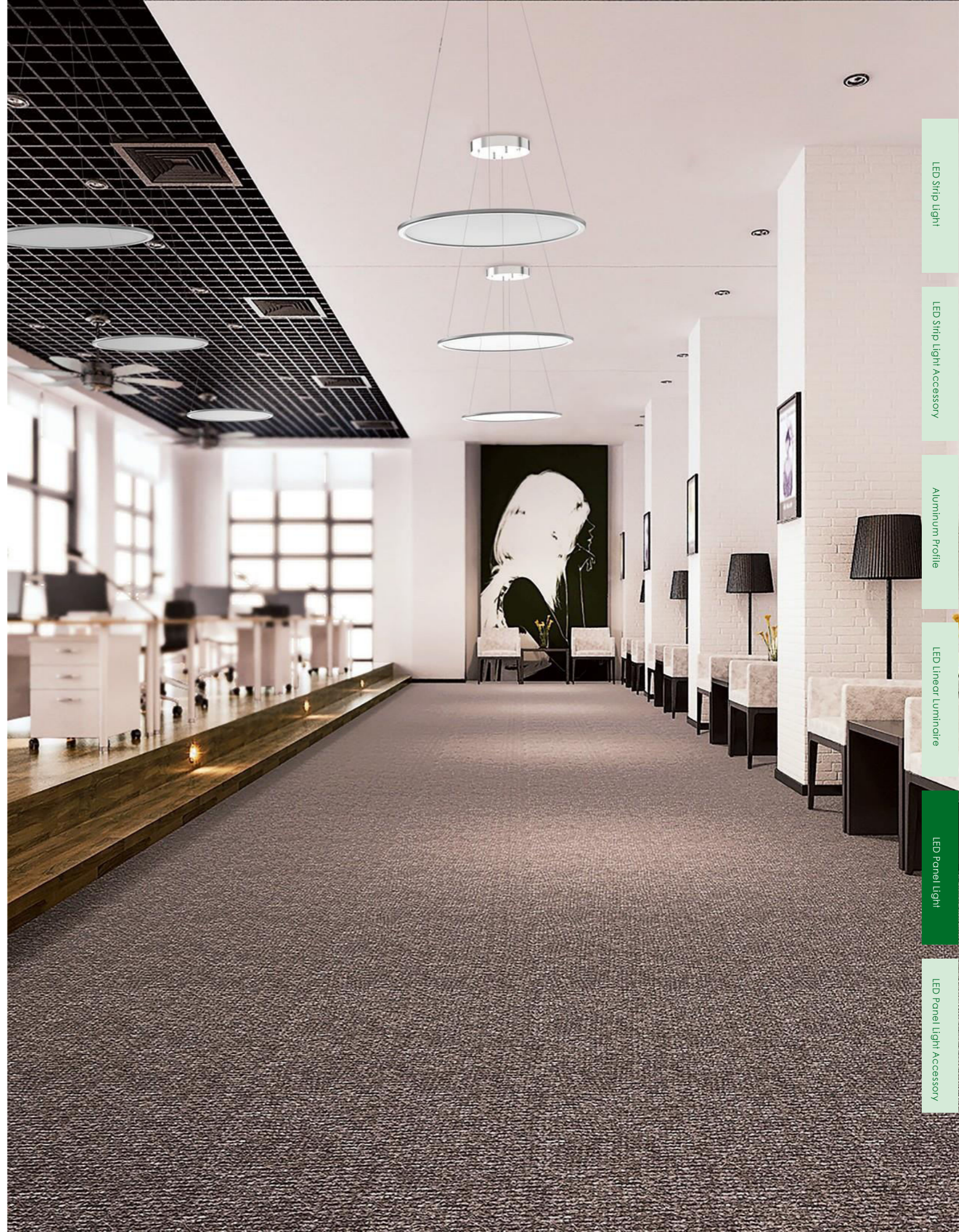
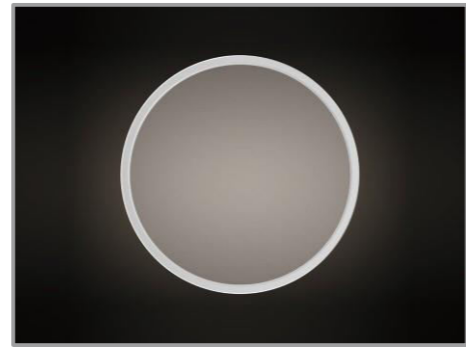
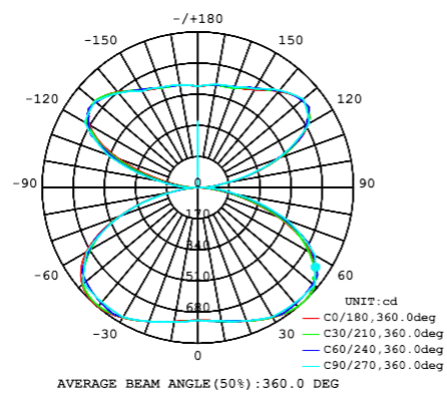
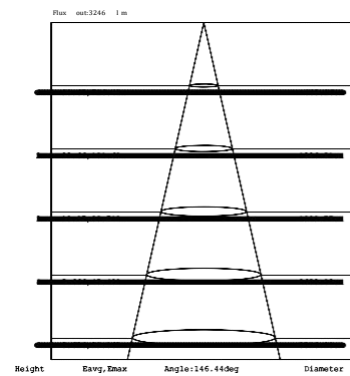

LED Strip Light

LED Strip Light Accessory

Aluminum Profile

LED Linear Luminaire

LED Panel Light

LED Panel Light Accessory

LED Strip Light

LED Strip Light Accessory

Aluminum Profile

LED Linear Luminaire

LED Panel Light

LED Panel Light Accessory

# CE LED Panel Light

## CCT Adjustable



Part Number:ES-PL6262CA

Power  
**46W**

CRI  
**Ra 80+**  
Ra 90+(available)

Size  
**620\*620MM**

Thickness  
**10MM**

Light efficiency  
**>55LM/W**  
(white)

Housing  
**Aluminum**  
(white paint/silver color)

Input  
**100-240VAC**

Color temp.  
**3000-6000K**

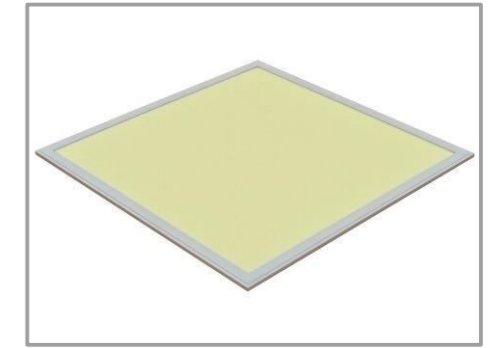

Model	Light color	Color temp.	Lumen	LM/W
ES-PL6262CA	warm white	3000K	1173LM	51LM/W
	white	6000K	1265LM	55LM/W

### Product Features:

1. CE approved
2. Uniform Super Bright Lighting
3. CCT adjustable from 3000-6000K, can choose different color via controller
4. Widely use and environment friendly without IR and UV radiation
5. Recessed mounted and ceiling or wall surface-mounted is optional
6. Up to 80% energy saving compared to standard CFL
7. Long lifetime of 40,000 hours

